

ELECTRIC POWER RATINGS GUIDE

Generator Sets

CONTENTS

RATINGS GUIDE

Caterpillar® Diesel Ratings	4
Caterpillar Diesel Rental Ratings	9
Caterpillar Diesel Ratings Definitions	10
Caterpillar Gas Ratings	14
Caterpillar Gas Ratings Definitions	19
Conversion Tables	22
Note Pages	33



CAT® GENERATOR SETS
DIESEL

CAT® 50 Hz DIESEL RATINGS

kVA			Generator Set Model	Configuration
Standby	Prime	Continuous		
1500 rpm				
300	275	–	3406C	Low BSFC
350	320	–	3406C	Low BSFC
400	365	–	3406C	Low BSFC
400	365	–	C15 ACERT™	EU Stage II, Low BSFC, Low Emissions
450	410	–	C15 ACERT	EU Stage II, Low BSFC, Low Emissions
500	455	–	C15 ACERT	EU Stage II, Low BSFC, Low Emissions
550	500	–	C15 ACERT	EU Stage II, Low BSFC, Low Emissions
550	500	–	C18 ACERT	Low BSFC, Low Emissions
600	545	–	C18 ACERT	Low BSFC, Low Emissions
605	550	–	C18 ACERT	EU Stage II
650	591	–	C18 ACERT	EU Stage II, Low BSFC, Low Emissions
700	635	–	C18 ACERT	Low BSFC
750	680	–	3412C	Low BSFC
800	725	–	3412C	Low BSFC
900	810	–	3412C	Low BSFC
1000	910	830	C32 ACERT	Low BSFC, Low Emissions
–	1000	906	3508B	Low BSFC, Low Emissions
1100	1000	910	C32 ACERT	Low BSFC, Low Emissions
1250	1150	1000	3512	Low BSFC
1400	1275	1206	3512	Low BSFC
1500	1360	1320	3512B	Low BSFC, Low Emissions
1600	1500	–	3512B	Low BSFC, Low Emissions
1750	1600	1500	3512B-HD	Low BSFC, Low Emissions
1875	1700	–	3512B-HD	Low BSFC, Low Emissions
2000	1825	1600	3516	Low BSFC
2250	2000	1750	3516B	Low BSFC, Low Emissions
2500	2275	2000	3516B-HD	Low BSFC, Low Emissions
3000	–	–	C175	Low BSFC
3100	–	–	C175	Low BSFC

CAT 50 Hz DIESEL RATINGS (CONT.)

kVA			Generator Set Model	Configuration
Standby	Prime	Continuous		
1000 rpm				
–	738	638	3508B	–
–	1050	969	3512	–
–	1100	1013	3512B	–
–	1400	1225	3516	–
–	1475	1288	3516B	–
–	–	1368	6CM20	–
–	–	1825	8CM20	–
–	–	2025	9CM20	–
2688	2425	2200	3606	–
3575	3250	2938	3608	–
5375	4850	4400	3612	–
7150	6500	5875	3616	–
750 rpm				
2163	1963	1775	3606	–
–	–	2225	6CM25	–
–	–	2875	8CM25	–
2863	2600	2363	3608	–
–	–	3238	9CM25	–
4325	3925	3550	3612	–
5725	5200	4725	3616	–
–	–	6988	12CM32	–
–	–	9313	16CM32	–
600 rpm				
–	–	3456	6CM32	–
–	–	4656	8CM32	–
–	–	5238	9CM32	–
500 rpm				
–	–	6550	6CM43	–
–	–	7638	7CM43	–
–	–	8725	8CM43	–
–	–	9825	9CM43	–
–	–	13094	12CM43	–
–	–	17463	16CM43	–

CAT 60 Hz DIESEL RATINGS

eKW		Generator Set		Configuration	Engine
Standby	Prime	Model			
Single Phase Output* 1800 rpm					
13	12	D13-4S	EPA Tier 4		C1.5
17	16	D17-4S	EPA Tier 4		C2.2
20	18	D20-6S	EPA Tier 4		C2.2
25	22	D25-8S	EPA Tier 4		C2.2
30	27	D30-8S	EPA Tier 4		C2.2
40	36	D40-6S	EPA Tier 3		C4.4
50	45	D50-6S	EPA Tier 3		C4.4
60	54	D60-8S	EPA Tier 3		C4.4
80	72	D80-6S	EPA Tier 3		C4.4
100	90	D100-6S	EPA Tier 3		C4.4
3-Phase Output** 1800 rpm					
13	12	D13-4	EPA Tier 4		C1.5
18	16	D18-4	EPA Tier 4		C2.2
20	18	D20-6	EPA Tier 4		C2.2
25	22	D25-8	EPA Tier 4		C2.2
30	27	D30-10	EPA Tier 4		C2.2
40	36	D40-6	EPA Tier 3		C4.4
50	45	D50-6	EPA Tier 3		C4.4
60	54	D60-6	EPA Tier 3		C4.4
80	72	D80-6	EPA Tier 3		C4.4
100	90	D100-6	EPA Tier 3		C4.4
125	114	D125-6	EPA Tier 3		C6.6
150	136	D150-8	EPA Tier 3		C6.6
175	158	D175-2	EPA Tier 3		C6.6

*All ratings at 1.0 pf **All ratings at 0.8 pf

CAT 60 Hz DIESEL RATINGS (CONT.)

eKW			Generator Set Model	Configuration
Standby	Prime	Continuous		
1800 rpm				
230	210	–	3306B	Low BSFC
250	–	–	3306B	Low BSFC
250	225	–	C9 ACERT™	EPA Tier 3

CAT 60 Hz DIESEL RATINGS (CONT.)

eKW			Generator Set Model	Configuration
Standby	Prime	Continuous		
1800 rpm				
300	275	–	C9 ACERT™	EPA Tier 3
300	275	–	3406C	Low BSFC
350	320	–	3406C	Low BSFC
350	320	–	C15 ACERT	EPA Tier 3, Low BSFC, Low Emissions
400	365	–	3406C	Low BSFC
400	365	–	C15 ACERT	EPA Tier 3, Low BSFC, Low Emissions
450	410	–	C15 ACERT	EPA Tier 3, Low BSFC, Low Emissions
500	455	–	C15 ACERT	EPA Tier 2, Low BSFC, Low Emissions
550	–	–	C15 ACERT	EPA Tier 2, Low BSFC, Low Emissions
(ESP) ¹	500	–	C18 ACERT	EPA Tier 2, Low BSFC
600	545	–	C18 ACERT	EPA Tier 2, Low BSFC
650	591	–	C27 ACERT	EPA Tier 2, Low BSFC
700	635	–	C27 ACERT	EPA Tier 2, Low BSFC
750	680	–	C27 ACERT	EPA Tier 2, Low BSFC
800	725	–	C27 ACERT	EPA Tier 2, Low BSFC
900	810	740	C32 ACERT	EPA Tier 2, Low BSFC
–	910	832	3508B	Low BSFC, Low Emissions
1000	910	830	C32 ACERT	EPA Tier 2, Low BSFC
1100	1000	890	3512	Low BSFC
1250	1135	1010	3512	Low BSFC
1400	1275	1230	3512B	Low BSFC, Low Emissions
1500	1360	1230	3512B	Low BSFC, Low Emissions
1500	1360	1230	3512C	EPA Tier 2
1750	1600	1450	3516	Low BSFC
2000	1825	1640	3516B	Low BSFC, Low Emissions
2000	1825	1650	3516C	EPA Tier 2
2250	–	–	3516B	EPA Tier 1, Low BSFC
2500	2250	2050	3516C-HD	EPA Tier 2
3000	–	–	C175-16	Low BSFC, EPA Tier 2
3100	–	–	C175-16	Low BSFC, EPA Tier 2

Note¹: (ESP) Emergency Standby Rating

CAT 60 Hz DIESEL RATINGS (CONT.)

ekW			Generator Set Model	Configuration
Standby	Prime	Continuous		
1200 rpm				
–	600	520	3508B	–
–	1015	890	3512B	–
–	1250	1100	3516	–
–	1285	1145	3516B	–
–	1450	1325	3516B	–
900 rpm				
–	–	980	6CM20	–
–	–	1300	8CM20	–
–	–	1470	9CM20	–
2000	1820	1650	3606	–
2660	2420	2200	3608	–
4000	3640	3300	3612	–
5320	4840	4400	3616	–
720 rpm				
1680	1525	1375	3606	–
–	–	1730	6CM25	–
2200	2020	1830	3608	–
–	–	2230	8CM25	–
–	–	2500	9CM25	–
3360	3050	2750	3612	–
4440	4040	3660	3616	–
–	–	5590	12CM32	–
–	–	7450	16CM32	–
600 rpm				
–	–	2765	6CM32	–
–	–	3725	8CM32	–
–	–	4190	9CM32	–
514 rpm				
–	–	5240	6CM43	–
–	–	6110	7CM43	–
–	–	6980	8CM43	–
–	–	7860	9CM43	–
–	–	10475	12CM43	–
–	–	13970	16CM43	–

CAT 60 Hz RENTAL UNIT RATINGS

ekW			Rental Generator Model	Configuration
Standby	Prime	Continuous		
1800 rpm				
20	18	–	XQ20	EPA Tier 4
30	27	–	XQ30	EPA Tier 4
45	41	–	XQ45	EPA Tier 3
60	54	–	XQ60	EPA Tier 3
80	70	–	XQ80	EPA Tier 3
100	90	–	XQ100	EPA Tier 3
230*	210	–	XQ230	EPA Tier 3
300*	275	–	XQ300	EPA Tier 3
400*	365	–	XQ400	EPA Tier 3
600	545	–	XQ600	EPA Tier 2
1000*	910	–	XQ1000	EPA Tier 2
2000	1825	–	XQ2000	EPA Tier 2

*Available at 50Hz

CAT DIESEL RATING DEFINITIONS:

Emergency Standby Power (ESP)

Output available with varying load for the duration of an emergency outage. Average power output is 70% of the standby power rating. Typical operation is 50 hours per year with maximum expected usage of 200 hours per year. Standby power in accordance with ISO8528 and ISO3046.

Standby Power

Output available with varying load for the duration of the interruption of the normal source power. Average power output is 70% of the standby power rating. Typical operation is 200 hours per year, with maximum expected usage of 500 hours per year. Standby power in accordance with ISO8528 and ISO3046.

Prime Power

Output available with varying load for an unlimited time. Average power output is 70% of the prime power rating. Typical peak demand of 100% of prime-rated kW with 10% of overload capability for emergency use for a maximum of 1 hour in 12. Overload operation cannot exceed 25 hours per year. Prime power in accordance with ISO8528 and ISO3046.

Continuous Power

Output available without varying load for an unlimited time. Average power output is 70 - 100% of the continuous power rating. Typical peak demand is 100% of continuous rated kW for 100% of operating hours. Continuous power in accordance with ISO8528 and ISO3046.

CAT GENERATOR SETS

GAS

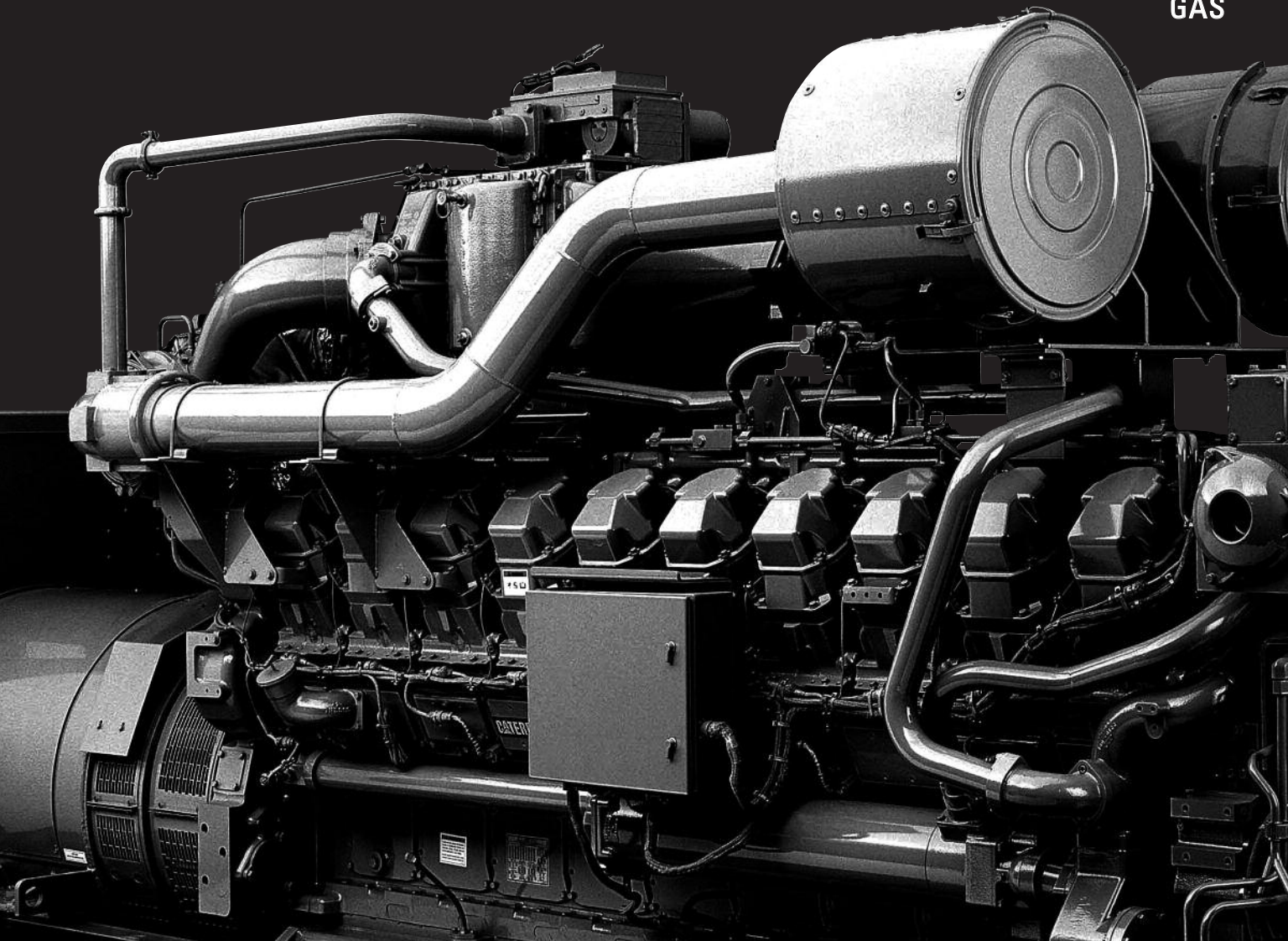

CAT 50 Hz CONTINUOUS GAS RATINGS

kVA 1000 rpm	kVA 1500 rpm	Natural Gas	Propane	Low Energy Gas
-	87	G3306 NA	-	-
-	106	G3306 NA	-	-
-	138	G3306 TA	-	-
-	156	G3306 TA	-	-
-	156	G3406 NA	-	-
-	194	G3408 NA ¹	G3408 NA ¹	-
-	200	G3406 TA	-	-
-	213	-	G3408 TA ¹	-
-	225	-	G3408 TA ¹	-
-	237	G3408 TA ¹	G3408 TA ¹	-
-	256	G3408 TA ¹	G3408 TA ¹	-
-	263	G3408 TA ¹	-	-
-	288	G3408 TA ¹	-	-
-	300	G3408 LE ¹	-	-
-	319	G3408 LE ¹	-	-
-	350	G3412 TA	-	-
-	450	G3412C LE	-	-
-	600	G3508 LE	-	-
-	619	G3508 LE	-	-
-	631	G3508 LE	-	-
-	638	G3508 LE	-	-
-	906	G3512 LE	-	-
-	931	G3512 LE	-	-
-	956	G3512 LE	-	G3512 LE
-	963	G3512 LE	-	-
-	1094	-	G3516 LE	-
-	1156	-	G3516 LE	-
-	1219	G3516 TA	-	-
-	1219	G3516 LE	-	-
-	1256	G3516 TA	-	-
-	1256	G3516 LE	-	-
-	1288	G3516 TA	-	-
-	1288	G3516 LE	-	G3516 LE
-	1356	G3516 B	-	-
-	1388	G3516 B	-	-
-	1431	G3516 B	-	-

Note¹: A factory supplied generator by DTO or a customer supplied generator needed.

CAT 50 Hz CONTINUOUS GAS RATINGS (CONT.)

kVA 1000 rpm	kVA 1500 rpm	Natural Gas	Propane	Low Energy Gas
1606	-	G3606	-	-
-	1615	G3520 B	-	-
-	1700	G3520 B	-	-
1712	-	G3606	-	-
-	1975	G3516 C	-	-
-	2000	G3516 C	-	-
2143	-	G3608	-	-
2281	-	G3608	-	-
-	2438	G3520 C	-	-
-	2458	G3520 CIM	-	G3520 CCMM
3212	-	G3612	-	-
3425	-	G3612	-	-
3593	-	G3612	-	-
3625	-	G3612	-	-
4281	-	G3616	-	-
4562	-	G3616	-	-
4825	-	G3616	-	-

CAT 50 Hz CONTINUOUS CHP GAS RATINGS

kVA 1000 rpm	kVA 1500 rpm	Natural Gas	Propane	Low Energy Gas
-	1380	G3516 B	-	-
-	1456	G3516 B	-	-
-	1825	G3520 B	-	-
-	1975	G3516 E	-	-
-	2000	G3516 E	-	-
-	2500	G3520 C	-	-
-	2500	G3520 E	-	-

CAT 60 Hz STANDBY GAS RATINGS

kW 1000 rpm	kW 1800 rpm	Natural Gas	Propane	Low Energy Gas
-	150	G3406 NA	-	-
-	240	G3406 TA	-	-
-	260	G3406 TA	-	-
-	270	-	G3408 TA ¹	-
-	275	G3406 TA	-	-
-	290	-	G3408 TA ¹	-
-	300	G3408 TA ¹	-	-
-	310	G3408 TA ¹	-	-
-	325	G3408 TA ¹	-	-
-	340	G3408 TA ¹	-	-
-	350	G3412 TA	-	-
-	375	G3412C LE	-	-
-	410	-	G3412 TA	-
-	435	G3412 TA	-	-
-	445	-	G3412 TA	-
-	450	G3412 TA	-	-
-	460	G3412 TA	-	-
-	470	G3412 TA	-	-
-	480	G3412 TA	-	-
-	495	G3412 TA	-	-
-	515	G3412 TA	-	-
-	1040	G3516 LE	-	-

CAT 60 Hz CONTINUOUS GAS RATINGS

kW 1200 rpm	kW 1800 rpm	Natural Gas	Propane	Low Energy Gas
-	85	G3306 NA	-	-
-	100	G3306 NA	-	-
-	135	G3306 TA	-	-
-	140	G3306 TA	-	-
-	150	G3306 TA	-	-

CAT 60 Hz CONTINUOUS GAS RATINGS (CONT.)

kW 1200 rpm	kW 1800 rpm	Natural Gas	Propane	Low Energy Gas
-	150	G3406 NA	-	-
-	175	-	G3408 NA ¹	-
-	190	G3406 TA	-	-
-	230	G3408 TA	G3408 TA ¹	-
-	250	G3408 TA ¹	G3408 TA ¹	-
-	255	G3408 TA ¹	-	-
-	280	G3408 TA ¹	-	-
-	350	G3412 TA	G3412 TA	-
360	-	G3508 LE	-	-
370	-	G3508 LE	G3412 TA	-
370	-	G3508 TA	-	-
-	375	G3412 TA	G3412 TA	-
-	375	G3412C LE	-	-
375	-	G3508 LE	-	-
380	-	G3508 TA	-	-
385	-	G3508 LE	-	-
390	-	G3508 LE	-	-
400	-	G3508 LE	-	-
555	-	G3512 TA	-	-
560	-	G3512 TA	-	-
570	-	G3512 TA	-	-
570	-	G3512 LE	-	-
585	-	G3512 LE	-	-
600	-	G3512 LE	-	-
695	-	-	G3516 LE	-
735	-	-	G3516 LE	-
750	-	G3516 TA	-	-
755	-	G3516 TA	-	-
770	-	G3516 TA	-	-
770	-	G3516 LE	-	-
795	-	G3516 LE	-	-
815	-	-	-	G3516 LE
820	-	G3516 LE	-	-

Note¹: A factory supplied generator by DTO or a customer supplied generator needed.

CAT 60 Hz CONTINUOUS GAS RATINGS (CONT.)

kW 900 rpm	kW 1200 rpm	kW 1800 rpm	Natural Gas	Low Energy Gas
1155	—	—	G3606	—
1235	—	—	G3606	—
—	—	1250	G3516BPM	—
—	—	1300	G3516B	—
—	—	1400	G3516B	—
1540	—	—	G3608	—
—	1600	—	G3520C	G3520C
—	—	1635	G3516C	—
1640	—	—	G3608	—
—	—	1660	G3516C	—
—	—	1900	G3520C	—
—	—	2055	G3520C	—
—	—	2055	G3520CIM	—
2310	—	—	G3612	—
2315	—	—	G3612	—
2335	—	—	G3612	—
2465	—	—	G3612	—
2595	—	—	G3612	—
2615	—	—	G3612	—
3080	—	—	G3616	—
3105	—	—	G3616	—
3285	—	—	G3616	—
3480	—	—	G3616	—

CAT GAS RATING DEFINITIONS:

Standby Power

These ratings are applicable for supplying continuous electrical power (at variable load) in the event of a utility power failure. No overload is permitted on these ratings. Natural gas ratings have been established on natural gas with net calorific Low Heat Value (LHV) of approximately 35.6 MJ/m³ (905 Btu/ft³) and 80 methane number (MN).

Continuous Power

Output available without varying load for an unlimited time. Continuous power in accordance with ISO8528, AS2789, and BS5514. Natural gas ratings have been established on natural gas with net calorific Low Heat Value (LHV) of approximately 35.6 MJ/m³ (905 Btu/ft³) and 80 methane number (MN).

ekW — Generator output at 0.8 pf

kVA — Generator output

CONVERSIONS

RATINGS GUIDE



CONVERSIONS

RATINGS GUIDE

CONVERSIONS

CONTINUED

FUEL SYSTEM - DIESEL

Day Tank Sizing

$$\text{Tank Size (gal)} = \frac{\text{Rated BSFC (lb/hp}\cdot\text{hr)}}{7.076 \text{ (lb/gal)}} \times \text{Rated HP} \times \text{Load Factor}$$

x Hours Between Refilling
+ Reserve Requirement

OR

Rule of Thumb for tank size with 25% reserve

$$0.056 \times \text{Ave. BHP demand} \times \text{Hours between refills} \times 1.25 = \text{_____ gal.}$$

$$0.27 \times \text{Ave. BKW demand} \times \text{Hours between refills} \times 1.25 = \text{_____ liters.}$$

Note: Additional tank capacity required for cooling of recirculated fuel in unit-injected engines. Tank should be located below level of injectors or nozzles.

On-Site Power Requirements

Based on 100,000 sq ft. of office bldg., etc and 40°N. Latitudes

- Electric Requirements
600 kW continuous load
(Air conditioning is absorption)
Use three - 300kW units
(2 prime and 1 standby)
- Air Conditioning and Compressor
400 tons prime load
Use two - 200 hp engines
(No Standby)

Refrigeration

- One ton refrigeration = 200 Btu/min = 12,000 Btu/h
- One Boiler hp = 33,475 Btu/h
- One ton compressor rating = One engine hp
- Auxiliary air conditioning equipment requires 1/4 hp/ton of compressor rating

Ice Plant

- Complete power requires 4-5 hp per daily ton capacity

Air Compressor

- hp = 1/4 x cu ft m/min at 100 psi
Increase bhp 10% for 125 psi
Decrease bhp 10% for 80 psi

ELECTRICAL TABLES

To Obtain	Alternating Current		Direct Current
	Single-Phase	Three-Phase	
Kilowatts	$\frac{V \times I \times P.F.}{1000}$	$\frac{1.732 \times V \times I \times P.F.}{1000}$	$\frac{V \times I}{1000}$
KVA	$\frac{V \times I}{1000}$	$\frac{1.732 \times V \times I}{1000}$	
Horsepower required when KW known (Generator)	$\frac{KW}{.746 \times \text{EFF. (Gen)}}$	$\frac{KW}{.746 \times \text{EFF. (Gen)}}$	$\frac{KW}{.746 \times \text{EFF. (Gen)}}$
KW input when HP known (Motor)	$\frac{HP \times .746}{\text{EFF. (Mot.)}}$	$\frac{HP \times .746}{\text{EFF. (Mot.)}}$	$\frac{HP \times .746}{\text{EFF. (Mot.)}}$
Amperes when HP known	$\frac{HP \times .746}{V \times P.F. \times \text{EFF.}}$	$\frac{HP \times .746}{1.732 \times V \times \text{EFF.} \times P.F.}$	$\frac{HP \times .746}{V \times \text{EFF.}}$
Amperes when KW known	$\frac{KW \times 1000}{V \times P.F.}$	$\frac{KW \times 1000}{1.732 \times V \times P.F.}$	$\frac{KW \times 1000}{V}$
Amperes when KVA known	$\frac{KVA \times 1000}{V}$	$\frac{KVA \times 1000}{1.732 \times V}$	
Frequency (c.p.s)	$\frac{\text{Poles} \times \text{RPM}}{120}$	$\frac{\text{Poles} \times \text{RPM}}{120}$	
Reactive kVA (KVAR)	$\frac{V \times I \times \sqrt{1-(P.F.)^2}}{1000}$	$\frac{1.732 \times V \times I \times \sqrt{1-(P.F.)^2}}{1000}$	
% Voltage Regulation	$\frac{100 (V_{NL} - V_{FL})}{V_{FL}}$	$\frac{100 (V_{NL} - V_{FL})}{V_{FL}}$	$\frac{100 (V_{NL} - V_{FL})}{V_{FL}}$

ELECTRICAL TABLE ABBREVIATIONS:

V - voltage in volts
I - current in amperes
KW - power in kilowatts (actual power)
KVA - kilovolt-amperes (apparent power)
HP - horsepower
RPM - revolutions per minute

KVAR - reactive kilovolt-amperes
EFF. - efficiency as a decimal factor
NL - no load
FL - full load
P.F. - power factor
 Note: DC KW = DC KVA

THREE-PHASE CONNECTION SYSTEMS

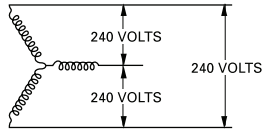

THREE-PHASE, THREE-WIRE (WYE)
A

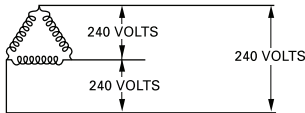

THREE-PHASE, THREE-WIRE (DELTA)
B

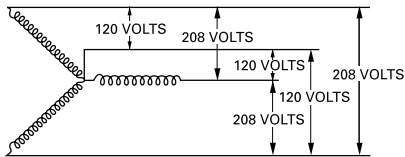

THREE-PHASE, FOUR-WIRE (WYE)
C

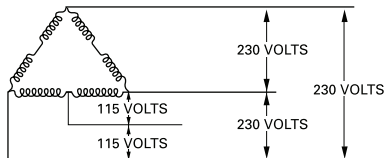

THREE-PHASE, FOUR-WIRE (DELTA)
D

REDUCED VOLTAGE STARTERS

Type of Starter	Motor Voltage (% Line Voltage)	Line Current (% Full Voltage) Starting Current	Starting Torque (% of Full Voltage) Starting Torque
Full Voltage Starter	100	100	100
Auto Transformer			
• 80% Tap	80	68	64
• 65% Tap	65	46	42
• 50% Tap	50	30	25
Resistor Starter Single Step (adjusted for motor voltage to be 80% of line voltage)	80	80	64
Reactor			
• 50% Tap	50	50	25
• 45% Tap	45	45	20
• 37.5% Tap	37.5	37.5	14
Part Winding (low-speed motors only)			
• 75% Winding	100	75	75
• 80% Winding	100	50	50

COMPARISON OF REDUCED VOLTAGE STARTING METHODS

Characteristic	Autotransformer	Primary Resistor	Reactor	Two-Step Part Winding
Starting Line Current at Same Motor Terminal Voltage	Least	— More than autotransformer type —		
Starting Power Factor	Low	High*	Low	Low
Power Draw from Line During Starting	Low	— More than autotransformer type —		
Torque	Increases slightly with speed	Increases rapidly with speed		Increases slightly with speed
Smoothness of Acceleration	Motor momentarily disconnected from line from start to run	Smooth. Transfer made with little change in motor terminal voltage		Smooth
Relative Cost	Average	Lower in small size-otherwise equal	Average	Less than others
Ease of Control	Same	Same	Same	No provision for adjustment of starting current
Maintenance	Same	Same	Same	Less than others
Line Disturbance	— Varies with conditions and type of load —			More than others

*Resistor starting adds considerable kW load to generator set. Total power required includes the motor kW and the kW which is lost as heat in the resistor. The series resistors account for a higher than normal starting power factor.

ENGINE ROOM VENTILATION

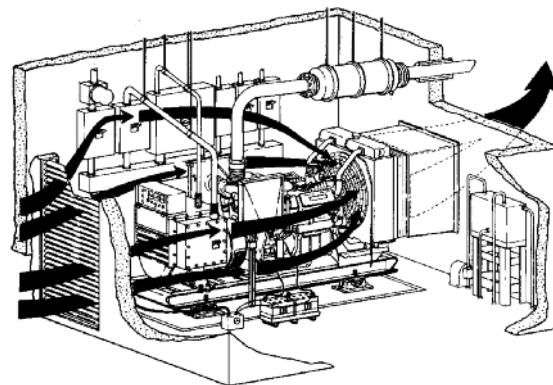

Engine room ventilation can be estimated by the following formulas, assuming 100°F (38°C) ambient air temperature:

$$V \text{ (cfm)} = \frac{H}{0.070 \times 0.24 \times \Delta T} + \text{Engine Combustion Air}$$

$$V \text{ (m}^3\text{/min)} = \frac{H}{1.099 \times 0.017 \times \Delta T} + \text{Engine Combustion Air}$$

V = Ventilation air (cfm) (m³/min).

H = Heat radiation (Btu/min) (kW).

ΔT = Permissible temperature rise in engine room (°F) (°C).

Density of air at 100°F = 0.070 lb/cu ft (1.099 kg/m³).

Specific heat of air = 0.24 Btu/°F (0.017 kW/°C).

CONVERSIONS

CONTINUED

CONVERSION FACTORS

Length							
Unit	mm	in	ft	yd	m	km	mi
mm	1	.03937	.003281	.001094	.001	.0000 01	—
in	25.4	1	0.083 33	0.027 78	0.0254	0.000 03	—
ft	304.8	12	1	0.333 33	0.3048	0.000 30	—
yd	914.4	36	3	1	0.9144	0.000 91	—
m	1000	39.3701	3.280 84	1.093 61	1	0.001	0.000 62
km	100 000	39 370.1	3208.84	1093.61	1000	1	0.621 37
mi	160 9340	63 360	5280	1760	1609.34	1.609 34	1

Area				
Unit	mm ²	in ²	m ²	ft ²
mm ²	1	0.00155	—	—
in ²	645.16	1	0.000 645 16	0.006 944
m ²	10 00000	1550	1	10.764
ft ²	92903	144	0.0929	1

1 sq mile = 640 acres
1 acre = 4840 yd²

1 cir mil = 7.854 x 10⁻⁷in²
1 cir mil = .7854 x mils²

1 cir mil = 5.067 x 10⁻⁶cm²

Weight						
Unit	Ounces		Pounds		Tons	
	Kilograms	Avoirdupois	Avoirdupois	Short	Long	Metric
1 Kilogram	1	35.27	2.205	—	—	—
1 Ounce	0.02835	1	0.0625	—	—	—
1 Pound	0.4536	16	1	—	—	—
1 Short Ton	907.2	32,000	2,000	1	0.8929	0.9072
1 Long Ton	1,016	35,840	2,240	1.12	1	1.016
1 Metric Ton	1,000	35,300	2,205	1.102	0.9842	1

1 grain = 0.064799 gram

CONVERSIONS

CONTINUED

CONVERSION FACTORS

Flow					
Unit	U.S.		million U.S.		
	gal/min	gal/day	ft ³ /s	m ³ /h	L/s
U.S. gpm	1	0.001 440	0.002 23	0.2270	0.0631
1 million gal/day	694.5	1	1.547	157.73	43.8
ft ³ /s	448.8	0.0646	1	101.9	28.32
m ³ /h	4.403	0.006 34	0.009 81	1	0.2778
L/s	15.85	0.0228	0.0353	3.60	1

MCFD = 1000 ft³/day

MMCFD = 1,000,000 ft³/day

lb/bhp-hr x 607.73 = g/kW-hr

Energy						
Unit	BTU	Cal	ft-lb	J	Kcal	Therm
BTU	1	252	778	1055.056	0.252	0.00001
Calorie	0.00397	1	3.08866	4.187	0.001	—
Foot-Pound	0.001285	0.323765	1	1.356	0.003089	—
Joule	0.000948	0.23895	0.73745	1	0.000239	—
Kilocalorie	3.96825	1000	3089	4185	1	2.519
Therm	100,000	396.8254	128.5347	94.78169	0.39682	1

1 Therm = 1,000,000 Btu

Btu/ft³ = 8.899 kg-cal/m³

Btu/ft²/min = 0.1220 Watts/in²

Btu/lb = .5556 kg-cal/kg

CONVERSIONS

CONTINUED

CONVERSIONS

CONTINUED

CONVERSION FACTORS

CONVERSION FACTORS

Volume and Capacity								
Unit	in ³	ft ³	yd ³	mm ³	m ³	U.S. gal	Imp gal	liter
in ³	1	0.000 58	0.000 02	16387.1	0.000 02	0.004 32	0.003 61	0.01639
ft ³	1728	1	0.037 04	28 320 000	0.028 32	7.480 52	5.228 83	28.3169
yd ³	46656	27	1	764 554 858	0.76455	201.974	168.178	764.555
mm ³	6.1 x 10 ⁻⁵	4.0 x 10 ⁻⁸	—	1	—	2.6 x 10 ⁻⁷	2.2 x 10 ⁻⁷	1.0 x 10 ⁻⁶
m ³	61 023.7	35.3147	1.307 95	1,000,000,000	1	264.192	219.969	1000
U.S.gal	231	0.133 68	0.004 95	3785420	0.003 78	1	—	3.785 41
Imp gal	277.419	0.160 54	0.005 95	4540090	0.004 55	1.200 95	1	4.546 09
liter	61.023 7	0.035 31	0.001 31	1000 000	0.001	0.264 17	0.219 97	1
acre-ft	—	43 560	1613.33	—	1233.48	325 851	271 335	—

1 board-foot = 144 in³

1 bushel = 1.244 ft³

1 bushel = 4 pecks

Power							
Unit	Btu/min	ft-lb/min	hp	J/min	Metric hp	kW	W
Btu/min	1	778.2	0.02358	1055.000	0.02391	0.0175843	17.5843
ft-lb/min	0.00128	1	0.00003	1.3504	0.00003	0.0000226	0.0226
Horsepower	42.456	33000	1	44791	1.014	0.74570	745.7
Joules/min	0.00095	0.7405	0.0000223	1	0.0000226	0.0000166	0.016668
Metric hp	41.827	32550	0.98632	44127	1	0.73549	735.498
Kilowatt	59	44250	1.34102	59997	1.35962	1	1000
Watt	0.05687	44.25	0.00134	59.9968	0.00136	0.001	1

Pressure and Head									
Unit	mm/Hg	in./Hg	in. H ₂ O	ft. H ₂ O	lb/in ²	kg/cm ²	bar	Atmospheres	
	(0°C)	(0°C)	(60°F)	(60°F)				101.4Pa (14.7 psi)	kPa
mm/Hg	1	0.039 37	0.5357	0.04464	0.019 34	0.001 36	0.001 33	0.001 315	—
in./Hg	25.4	1	13.61	1.134	0.491 15	0.034 53	0.033 86	0.033 42	—
in. H ₂ O	1.868 27	0.07 355	1	0.083 33	0.036 13	0.002 54	0.002 49	0.002 46	0.249
ft. H ₂ O	22.4192	0.882 65	12	1	0.433 52	0.030 479	0.029 89	0.029 50	2.989
lb/in ²	51.7149	2.036 02	27.70	2.309	1	0.070 31	0.068 95	0.068 05	6.895
kg/cm ²	735.559	28.959	395	32.84	14.2257	1	0.980 67	0.967 84	98.067
bar	750.062	29.530	401.8	33.49	14.504	1.019 72	1	0.98692	101.325
kPa	7.500 62	0.295 30	4.01835	0.33486	0.145 038	0.010 1972	0.010 000	0.009 869 20	1

CONVERSION FACTORS

Temperature Conversion

$$^{\circ}\text{F} = (1.8 \times ^{\circ}\text{C}) + 32$$

$$^{\circ}\text{C} = 0.5555 (^{\circ}\text{F} - 32)$$

Angle

1 quadrant = 90 degrees

1 quadrant = 1.57 radians

1 radian = 57.3

1 degree = 60 minutes

1 minute = 2.9×10^{-4} radians

Identifying Code Letters on AC Motors

NEMA Code Letter	Starting skVA/hp
A	0.00 - 3.14
B	3.15 - 3.54
C	3.55 - 3.99
D	4.00 - 4.49
E	4.50 - 4.99
F	5.00 - 5.59
G	5.60 - 6.29
H	6.30 - 7.09
J	7.10 - 7.99
K	8.00 - 8.99
L	9.00 - 9.99
M	10.00 - 11.19
N	11.20 - 12.49
P	12.50 - 13.99
R	14.00 - 15.99
S	16.00 - 17.99
T	18.00 - 19.99
U	20.00 - 22.39
V	22.40

Note: Code letters apply to motors up to 200 HP.

NOTES

To find your nearest dealer go to:
www.cat-electricpower.com

LEXE7582-00

June 2008

© 2008 Caterpillar All Rights Reserved Printed in USA CAT, CATERPILLAR, their respective logos, ACERT, ADEM, "Caterpillar Yellow" and the POWER EDGE trade dress, as well as corporate and product identity used herein, are trademarks of Caterpillar and may not be used without permission.

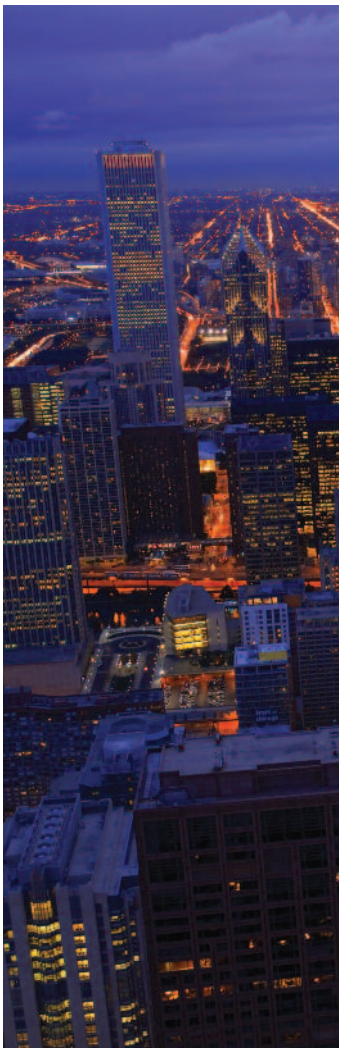

CATERPILLAR[®]
TODAY'S WORK. TOMORROW'S WORLD.™