



2016 Cat[®] Hand Tools and Shop Supplies



Section	Page
Introduction	3
Hand Tools	5
Tool Sets — Hand Tool Sets	12
Tool Sets — Field Tool Sets	26
Wrenches — Cat® Standard Wrenches	28
Wrenches — Cat Ratcheting Wrenches	33
Wrenches — Angle Wrenches	37
Wrenches — Adjustable Wrenches	39
Wrenches — Pipe Wrenches	40
Wrenches — Chain Wrenches	42
Wrenches — Filter Wrenches	43
Wrenches — Hex Wrenches	44
Wrenches — Special Application Wrenches	48
Wrenches — Crowfoot Wrenches	52
Ratchets and Sockets — Ratchet and Socket Sets	55
Ratchets and Sockets — Ratchets and Repair Kits	60
Ratchets and Sockets — Ratchet Handles and Breaker Bars	62
Ratchets and Sockets — Cat Sockets - 3/8 inch Drive	64
Ratchets and Sockets — Cat Sockets - 1/4 inch Drive	68
Ratchets and Sockets — Cat Sockets - 1/2 inch Drive	70
Ratchets and Sockets — Impact Socket Sets - 3/8 inch Drive	73
Ratchets and Sockets — Impact Socket Sets - 1/2 in Square Drive	77
Ratchets and Sockets — Impact Socket Sets - 3/4 in Square Drive	80
Universal and Swivel Socket Sets - 3/8 inch Square Drive	81
Universal and Swivel Socket Sets - 1/2 inch Drive	83
Ratchets and Sockets — Twist Sockets - 3/8 inch Square Drive	85
Ratchets and Sockets — Individual Sockets	86
Ratchets and Sockets — Special Application Sockets	106
Ratchets and Sockets — Extensions/Adapters	113
Cordless Power Tools	116
Pneumatic Tools — Impact Wrenches	118
Pneumatic Tools — Sanders and Polishers	123
Pneumatic Tools — Grinders	125
Pneumatic Tools — Drills	126
Pneumatic Tools — Air Hammers	127
Pneumatic Tools — Ratchet	128
Pneumatic Tools — Shears	129
Pneumatic Tools — Engraver	130
Pneumatic Tools — Air Guns	131
Pneumatic Tools — Spray Guns	134
Torque Tools — Torque Wrenches, Adapters, and Extensions	136
Torque Tools — Torque Testers	141
Grease Guns	143
Cat Screwdrivers	147
Cat Pliers	151
Hammers and Slide Sledges	155
Chisels and Punches	160
Pry Bars	162
Miscellaneous Hand Tools — Knives, Saws and Cutting Tools	164
Miscellaneous Hand Tools — Levels, Measuring Tools and Gauges	171
Miscellaneous Hand Tools — Seal Picks	177
Miscellaneous Hand Tools — Brushes	178

Table of Contents

Miscellaneous Hand Tools — Miscellaneous	181
Tool Boxes.....	185
Shop Supplies	197
Abrasives — Brushes	206
Abrasives — Discs.....	209
Abrasives — Wheels.....	221
Abrasives — Miscellaneous	232
Metal Cutting — Drill Bits	243
Metal Cutting — Taps and Dies	249
Metal Cutting — Extractors	258
Metal Cutting — Cutting Torch Equipment	263
Metal Cutting — Miscellaneous	264
Metal Repair	265
Caps and Plugs.....	281
Vises	294
Battery Service Equipment.....	298
Lighting and Electrical Products — Flashlights and Batteries	307
Lighting and Electrical Products — Work Lights and Extension Cords	312
Lighting and Electrical Products — Miscellaneous	318
Personal Protective Equipment — Gloves.....	323
Personal Protective Equipment — Safety Vests	337
Personal Protective Equipment — Eye Protection	338
Personal Protective Equipment — Hearing Protection	348
Personal Protective Equipment — Hard Hats	351
Personal Protective Equipment — Breathing Protection.....	352
Personal Protective Equipment — First Aid Kits	354
Personal Protective Equipment — Welding Protection	358
Contamination Control	360
Fluid Sampling Equipment	363
Towels and Wipers	368
Absorbents and Spill Kits — Absorbents.....	373
Absorbents and Spill Kits — Spill Kits	379
Floor Mats	383
Tape	385
Packing Supplies and Equipment.....	391
Miscellaneous — Padlocks.....	398
Miscellaneous — Ladders.....	400
Miscellaneous — Janitorial Products	401
Miscellaneous — Highway Warning Kit	403
Miscellaneous — Sprayers	404
Miscellaneous — Miscellaneous Products	405
Paint — Cat Paint	412
Paints — Paint Thinner.....	414
Maintenance Chemicals — Soaps and Cleaners.....	415
Maintenance Chemicals — Adhesives and Sealants	421
Maintenance Chemicals — Lubricants	423
Maintenance Chemicals — Metal Working	426
Maintenance Chemicals — Testing Products	427
Maintenance Chemicals — Rust Preventatives	431
Maintenance Chemicals — Miscellaneous Chemicals	432
Part Number Index.....	435

Hand Tools and Shop Supplies

The Hand Tools and Shop Supplies catalog incorporates all of the shop supplies, general purpose hand tools, tool boxes, and personal safety items for dealer and customer service shops.

Ordering Procedure

Most products listed in PECJ0003 are stocked at Cat parts facilities. All products in PECJ0003 can be ordered through the Cat Parts Distribution system using existing stock or emergency ordering procedures.

Prices

Prices are subject to change without notice. Standard dealer payment terms apply for any product ordered from this catalog (whether it is stocked or direct shipped).

Warranty Claims Process

Customers:

In the event that a warranty claim needs to be filed, contact your Cat dealer.

Dealers:

The products offered in this catalog are covered by the standard six-month Caterpillar warranty unless they are covered by a manufacturer warranty. Where possible, the warranty type is listed in the product details. The most up-to-date information on warranty type and length is available in the Cat Dealer Numerical Parts Record (NPR) system. For more warranty information and a sample claims form, visit dealer.cat.com/toolsandsupplies.

Questions Customers:

Contact your local Cat Dealer with any questions you may have about the products listed in this catalog.

Questions Dealers:

For more information about any of the products listed in the catalog contact the Global Dealer Services Network.

Global Dealer Services Network

Parts Technical Support Team

North America: 1 (877) 228-2420

International: 1 (309) 266-4421

Email: Tech_Support@cat.com

Suggest a Product for the Cat Hand Tools and Shop Supplies Catalog

Did you find the product you were looking for? If not, suggest a product at toolsandsupplies@cat.com.

Tool Sets — Hand Tool Sets	12
Serviceman's Tool Set, 117 Piece Set - 8T-0460	12
Serviceman's Tool Set, 95 Piece Set - 8T-0461	15
Student Tool Set - 222-7876	18
Hand Tool Set - 211-0616.....	19
Hand Tool Set - 211-0617.....	20
Hand Tool Set - 214-6153.....	20
Hand Tool Set - 214-7318.....	21
Hand Tool Set - 214-7219.....	22
Hand Tool Set - 157-0674.....	23
Hand Tool Set - 207-1515.....	24
Hand Tool Set - 256-4816.....	24
Tool Sets — Field Tool Sets	26
Field Tool Set - 133-8877.....	26
Field Tool Set - 144-4674.....	26
Field Tool Set - 152-4942.....	27
Wrenches — Cat® Standard Wrenches	28
Fractional Combination Wrench Set, Standard Length, 11 Piece - 4C-9600	28
Fractional Short Length Combination Wrench Set, 9 Piece - 4C-9610	28
Metric Combination Wrench Set, 14 Piece - 1U-5545	29
Metric Combination Wrench Set, 10 Piece - 233-1632	30
Fractional Combination Wrenches	30
Metric Combination Wrenches.....	31
Metric Combination Wrenches.....	32
Wrenches — Cat Ratcheting Wrenches	33
Fractional Ratcheting Wrench Set, 8 piece - 248-8810.....	33
Ratcheting Box Wrench.....	33
Fractional Straight Handle Wrench Set, 11 Piece - 8T-3120	33
Fractional Straight Handle Wrench Set, 6 Piece - 8T-3227.....	34
Metric Ratcheting Wrench Set, 12 piece - 248-8819.....	34
Ratchet Wrench - 9U-6517	35
Ratcheting Box Flare Wrench, 3/4 inch Square Drive.....	36
Wrenches — Angle Wrenches	37
Angle Wrench Set, 30° and 60° Offset, 14 Piece - 1P-3515	37
Angle Wrench Set, 7 Piece - 233-1635	37
Angle Wrench Set, Large, 7 Piece - 233-1636	38
Half-Moon Wrench - 194-4935.....	38
Wrenches — Adjustable Wrenches	39
Heavy-Duty Adjustable End Wrench.....	39
Adjustable Wrenches.....	39
Wrenches — Pipe Wrenches	40
Aluminum Pipe Wrenches.....	40
Heavy-Duty Pipe Wrenches.....	40
48 Inch Pipe Wrench - 386-3304	40
48 inch Pipe Wrench.....	41
60-Inch Pipe Wrench - 423-8977	41
Wrenches — Chain Wrenches	42
Chain Wrench for Special Applications - 1U-8760	42
Chain Wrench Group - 3P-1535	42
Wrenches — Filter Wrenches	43
Filter Strap Wrench - 185-3630	43
Filter Wrench - 187-2718	43
Wrenches — Hex Wrenches	44
Fractional Hex Bit Set, 9 Piece - 9S-1742.....	44
Fractional "L" Shaped Hex Key Wrench Set, 13 Piece - 200-1928	44
Fractional Hex Key Wrench Set with Ball End, 13 Piece - 293-3025	44

Hand Tools

Metric Hex Bit Set, 7 Piece - 200-1931	45
Metric "L" Shaped Hex Key Wrench Set, 9 Piece - 200-1929	45
Metric Hex Key Wrench Set with Ball End, 9 Piece - 293-3026	45
"L" Shaped Torx Wrench T50 - 256-4879.....	45
Hex Key Wrenches, Standard and Metric.....	46
T-Handle Allen Head Wrench Set	46
Hollow Head Screw Hex Wrenches	47
Wrenches — Special Application Wrenches	48
Spark Plug Wrench - 2P-5481	48
Open End Wrenches	48
Wrench, 41.0 mm - 214-7329	48
Wrench, 55.0 mm - 4C-4065	49
Special Open End Wrenches	49
Wrench Set, Double End Flare Nut, 3 Piece - 214-7335	49
Individual Offset Wrenches, Double End Flare Nut	50
Special Application Wrenches	50
Saw Adjustment Wrench - 197-3672.....	50
Heavy-Duty Box Wrenches	51
Nut Spanner Wrenches	51
Slug Wrenches	51
Wrenches — Crowfoot Wrenches	52
Fractional Open-End Crowfoot Wrench Group, 9 piece, 3/8 inch Drive - 2P-5520	52
Fractional Crowfoot Wrench Group, 11 Piece - 5P-0336.....	52
15-Piece 1/2-inch Fractional Crowfoot Wrench Set	53
Metric Flare Nut Crowfoot Wrench Set - 305-3129.....	53
Ratchets and Sockets — Ratchet and Socket Sets	55
Fractional Socket Set, 17 Piece, 1/4 inch Drive - 213-4443	55
Fractional Socket Set, 11 Piece, 3/8 inch Drive - 9S-1746	55
Fractional Socket Set, 16 Piece, 1/2 inch Drive - 9S-1748	56
Fractional Socket Set, 21 Piece, 3/4 inch Drive - 9S-1749.....	57
Fractional Heavy-Duty Socket Set, 17 Piece, 1 inch Drive - 5S-6093	58
Metric Ratchet Set, 17 Piece, 1/4 inch Drive - 233-1642	59
Ratchets and Sockets — Ratchets and Repair Kits	60
Ratchet Set, 3 Piece - 233-1637	60
Ratchets.....	60
Ratchet Heads.....	61
Ratchets and Sockets — Ratchet Handles and Breaker Bars	62
Handles.....	62
Head Breaker Bar, 3/4 inch Drive - 8H-8546	62
Breaker Bars.....	62
Sliding T-Handle.....	62
Sliding "T" Wrench Head - 5S-6090.....	63
Speeder Handle, 3/8 inch Drive - 8H-8573.....	63
Hand Impact Wrench - 5P-2410.....	63
Ratchets and Sockets — Cat Sockets - 3/8 inch Drive	64
Fractional Socket Set, 7 Piece, 3/8 inch Drive - 214-1143	64
Fractional Socket Set, 9 Piece, 3/8 inch Drive - 214-1151	64
Fractional Socket Set, 9 Piece, 3/8 inch Drive - 214-6490	65
Metric Socket Set, 12 Piece, 3/8 inch Drive - 194-3574	65
Metric Socket Set, 12 Piece, 3/8 inch Drive - 199-9019	66
Metric Socket Set, 12 Piece, 3/8 inch Drive - 214-6620	66
Metric Socket Set, 8 Piece, 3/8 inch Drive - 214-6634.....	67
Ratchets and Sockets — Cat Sockets - 1/4 inch Drive	68
Fractional Socket Set, 10 Piece, 1/4 inch Drive - 213-9965.....	68
Metric Socket Set, 13 Piece, 1/4 inch Drive - 200-8413	68
Metric Socket Set, 9 Piece, 1/4 inch Drive - 194-3578.....	69

Ratchets and Sockets — Cat Sockets - 1/2 inch Drive	70
Fractional Socket Set, 12 Piece, 1/2 inch Drive - 214-6498	70
Fractional Deep Well Socket Set, 9 Piece, 1/2 inch Drive - 2P-5490	70
Fractional Socket Set, 11 Piece, 1/2 inch Drive - 214-1161	71
Metric Socket Set, 13 Piece, 1/2 inch Drive - 199-6156	71
Metric Socket Set, 10 Piece, 1/2 inch Drive - 194-3576	72
Ratchets and Sockets — Impact Socket Sets - 3/8 inch Drive	73
Fractional Impact Socket Set, 12 Piece, 3/8 inch Drive - 271-4600	73
Fractional Impact Socket Set, 7 Piece, 3/8 inch Drive - 271-4613	73
Fractional Impact Socket Set, 12 Piece, 3/8 inch Drive - 271-4669	74
Metric Impact Socket Set, 14 Piece, 3/8 inch Drive - 271-4622	74
Metric Impact Socket Set, 14 Piece, 3/8 inch Drive - 271-4654	75
Metric Impact Socket Set, 14 Piece, 3/8 inch Drive - 271-4638	75
Metric Impact Socket Set, 14 Piece, 3/8 inch Drive - 271-4683	76
Ratchets and Sockets — Impact Socket Sets - 1/2 in Square Drive	77
Fractional Impact Socket Set, 11 Piece 1/2 inch Drive - 213-3086	77
Fractional Impact Socket Set, 12 Piece 1/2 inch Drive - 213-3515	77
Metric Impact Socket Set, 12 Piece 1/2 inch Drive - 213-6923	78
Metric Impact Socket Set, 11 Piece 1/2 inch Drive - 214-6643	78
Ratchets and Sockets — Impact Socket Sets - 3/4 in Square Drive	80
Metric Impact Socket Set, 24 Piece 3/4 inch Drive - 9U-6547	80
Universal and Swivel Socket Sets - 3/8 inch Square Drive	81
Fractional Universal Socket Set, 7 Piece, 3/8 inch Drive - 9S-1747	81
Fractional Universal Socket Set, 7 Piece, 3/8 inch Drive - 261-8581	81
Metric Universal Socket Set, 9 Piece, 3/8 inch Drive - 9U-6124	82
Metric Universal Socket Set, 7 Piece, 3/8 inch Drive - 261-8572	82
Universal and Swivel Socket Sets - 1/2 inch Drive	83
Fractional Universal Impact Socket Set, 5 Piece, 1/2 inch Drive - 214-6518	83
Fractional Universal Impact Socket Set, 14 Piece, 1/2 inch Drive - 246-8184	83
Metric Universal Impact Socket Set, 10 Piece, 1/2 inch Drive - 246-8199	84
Ratchets and Sockets — Twist Sockets - 3/8 inch Square Drive	85
Fractional Twist Socket Set, 13 Piece, 3/8 inch Drive - 241-0873	85
Ratchets and Sockets — Individual Sockets	86
Individual Fractional Sockets, 1/4 in Drive	86
Individual Fractional Sockets, 3/8 in Drive	86
Individual Fractional Sockets, 1/2 in Drive	89
Individual Fractional Sockets, 3/4 in Drive	92
Individual Fractional Sockets, 1 in Drive	94
Individual Fractional Sockets, 1 1/2 in Drive	96
Individual Metric Sockets, 1/4 in Drive	97
Individual Metric Sockets, 3/8 in Drive	98
Individual Metric Sockets, 1/2 in Drive	100
Individual Metric Sockets, 3/4 in Drive	102
Individual Metric Sockets, 1 in through 2 1/2 in Drive (also No. 5 Spline)	103
Ratchets and Sockets — Special Application Sockets	106
Fractional Hex Driver Set, 10 Piece - 214-6142	106
Fractional Hex Ball Driver Socket Set, 8 Piece - 246-8499	106
Metric Hex Driver Set, 9 Piece - 194-3585	107
Metric Hex Ball Driver Socket Set, 8 Piece - 243-5182	108
Individual Fractional Hex Driver Sockets	108
Drivers for TORX Screws	108
TORX Driver Set, 10 Piece - 194-3584	109
Inverted TORX Socket Set, 10 Piece - 227-4383	109
Pin Socket - 5P-5249	110
Hex Socket, 55 mm (Spline Drive) - 159-2833	110
Stacking Sockets (Metric)	111

Hand Tools

Special Large Socket Wrenches	111
Lock Removal Socket.....	111
Spark Plug Sockets.....	112
Ratchets and Sockets — Extensions/Adapters	113
Universal Joint Extension Socket.....	113
Socket Extensions	113
Universal Drives.....	113
Ratchet Adapter - 1P-0853.....	114
Hex Shank - 4C-9818	114
Universal Joint - 4C-9819	114
Socket Drive Adapters	115
Impact Wrench Socket Adapters.....	115
Universal Joint.....	115
Cordless Power Tools	116
463-6821 Cordless Impact Wrench Kit (18v).....	116
Cordless Drill Kit (18v) - 151-0968	116
Heavy-Duty Angle Grinder, 11,000 RPM, 4.5 inch - 288-2512.....	117
Pneumatic Tools — Impact Wrenches	118
Composite Pneumatic Impact Wrenches.....	118
Impact Wrenches, 3/8 inch.....	119
Impact Wrenches, 1/2 and 3/4 inch	120
Impact Wrenches, 1 inch	121
Impact Wrenches Repair Kits	122
Pneumatic Tools — Sanders and Polishers	123
Sanders and Polishers	123
Pneumatic Tools — Grinders	125
Air Grinders	125
Pneumatic Tools — Drills	126
Air Drills	126
Pneumatic Tools — Air Hammers	127
Air Hammer - 222-3080.....	127
Air Hammer Accessories	127
Pneumatic Tools — Ratchet	128
Air Ratchet - 222-3059	128
Pneumatic Tools — Shears	129
Shears - 222-3083	129
Pneumatic Snap Ring Tool - 430-4389	129
Pneumatic Tools — Engraver	130
Air Engraver - 223-1154.....	130
Pneumatic Tools — Air Guns	131
Safety Air Guns.....	131
Jet Guard Safety Air Gun - 441-5255.....	131
Jet Guard Safety Air Gun	132
Safety Blow Guns.....	132
Gun Vac®.....	132
Pneumatic Tools — Spray Guns	134
Pneumatic Syphon Spray Gun - 441-5254.....	134
Pneumatic Syphon Spray Gun - 4C-5746.....	134
Spray Gun Canister.....	134
Pneumatic Oil Gun.....	135
Torque Tools — Torque Wrenches, Adapters, and Extensions	136
Cat Electronic Torque Wrenches	136
Click Type Torque Wrenches	137
Dial Type Torque Wrenches.....	138
Heavy-Duty Box Wrenches	138
Torque Wrench Extensions.....	139

Adapters and Extensions for Torque Wrenches	139
Special Torque Wrench Extensions	140
Torque Computer - 376-4937	140
Torque Tools — Torque Testers	141
Degree Wheel - 8T-3052	141
Mechanical Torque Tester - 1P-7460	141
Electronic Torque Testers	142
Grease Guns	143
Megaboost Lock-n-Load Grease Gun - 385-1742	143
Workforce Pro Grease Gun - 385-1743	143
Lever Grease Gun, Model Pro "L" - 8F-9866	143
Pistol Grip Grease Gun - 190-5622	144
Electric Grease Gun	145
Cordless Electric Grease Gun - 241-0706	145
Cat Screwdrivers	147
Screwdriver Set, 5 Piece - 233-1640	147
Screwdriver Set - 9U-7290	147
Black Plastic Handle Screwdriver Set, 6 Piece - 162-7804	147
Black Plastic Handled Screwdrivers	148
Ratcheting Screwdriver, 5 Bits - 9U-7291	148
32-Piece Screwdriver Set 386-3366	148
Insulating Screwdriver	149
Nutdrivers	149
Torx Driver Set	149
Torx Driver	150
Tool Bit Set, 6 Piece - 9U-7328	150
Off-Set Slotted Screwdriver - 5P-0302	150
Cat Pliers	151
Yellow Grip Pliers Set, 3 Piece - 233-1639	151
Cat Locking Pliers Set, 5 Piece - 316-0707	151
Combination and Multiple Position Pliers	151
Soft Jaw Pliers – 6V-0006	152
Retaining Ring Pliers	152
External Pliers - 5P-5197	153
Internal Retaining Ring Pliers - 1U-8758	153
Pliers 444-6561	153
External Retaining Ring Pliers - 2P-8312	154
Hammers and Slide Sledges	155
Slide Sledge® Heavy Equipment Hammers	155
Slide Sledge Tips	155
Slide Sledge Accessories	156
Slide Sledge Hammer Repair Parts	157
Hammers	157
Multiple Use Hammers	158
Handled Tooth Pin Removers	159
Handheld Tooth Pin Removers	159
Chisels and Punches	160
Pin Punch Set, 7 Piece - 226-1900	160
Drift Punch Set, 5 Piece - 227-3129	160
Chisel Group, 5 Piece - 227-3795	161
Individual Chisels and Punch Pieces	161
Pry Bars	162
Pry Bars	162
Bead Braker Bar - 4F-5166	162
Pry Bar Display - 244-0910	162
Handled Pry Bars	163

Hand Tools

Handled Pry Bar - 160-5119	163
Miscellaneous Hand Tools — Knives, Saws and Cutting Tools	164
3-inch Stainless Steel Lockback - 429-0608.....	164
5-inch Textured Stainless Steel Lockback - 429-0610	164
5-inch Heavy-Duty Wood and Brass Lockback - 429-0611	165
5-inch Wood Inset Liner Lock - 429-0612	165
5-inch G10 Liner Lock - 429-0613 and 429-0614.....	166
17-Function Multi-tool - 429-0609	166
3 3/4-inch Two-Blade Electricians Knife - 429-0615	167
Utility Knife - 429-0616	167
Utility Knife Blades	168
Single Edge Razor Blades	168
Hacksaws.....	168
File Set, 8 piece	169
Filter Cutter - 175-7546.....	169
Quick Release Tubing Cutters	170
Miscellaneous Hand Tools — Levels, Measuring Tools and Gauges	171
Universal Level - 9U-7329	171
Protractor - 441-3703.....	171
Tape Measures	171
Angle Finder and Level	172
Tape Measures	172
Steel Tape Measure.....	173
1000 mm Straight Edge - 386-3364.....	173
Taper Gauge - 4C-8733	173
Block Magnet - 4C-9798.....	174
O-Ring Measuring Cone - 9U-5155	174
Check-A-Thread.....	174
Feeler Gauges	175
Dual Scale Feeler Gauge Set, 13 Blade - 383-8887.....	175
Plastic Gauges for Checking Clearance	175
Hardness Tester - 6V-6035.....	176
Thread Pitch Gauges.....	176
Miscellaneous Hand Tools — Seal Picks	177
Seal Pick - 5P-1720	177
Seal Pick Kit - 5P-7414.....	177
Seal Pick - 195-4609	177
Miscellaneous Hand Tools — Brushes	178
Scratch Brushes	178
Corner Cleaner Wire Brush - 160-0774.....	178
Longneck Wire Brush - 160-0772	178
Industrial Wire Scrubber - 160-0775	179
Parts Cleaning Brushes	179
Paint Brushes.....	179
Acid Brushes.....	179
Battery Post Brush - 1U-9921.....	180
Miscellaneous Hand Tools — Miscellaneous	181
Rivet Sets	181
Riveter Kit - 129-1063.....	181
Shovels and Spades	181
Retrieval Tools	182
Inspection Mirror	182
Scraper	182
Filter and Plug Removal and Installation Tools.....	182
Cab Glass Installation Tools.....	183
Superior E-Z Thrust Caulker.....	183

Super Ratchet-Type Caulker	183
BIM Saw Blades	183
Bi-Metal All-Purpose Tiger Saw Blades	184
Terminal Tool Group - 435-5074.....	184
Tool Boxes	185
Cat 55-Inch Tool Boxes	185
Cat 40-Inch Tool Boxes	186
Cat 26-Inch Tool Boxes	187
Drop Front Tool Chest - 329-6983.....	188
Cat Well Cabinet - 471-9317	188
Cat Multi-Purpose Roll Cart - 385-1737	189
All-Purpose Roll Cart - 385-1738	189
Tool Bag with Carrying Strap - 248-2283	189
Cordura Cloth Tool Bag.....	190
Heavy Duty Plastic Tool Box - 329-6922	190
Tool Box - 9U-6219.....	190
Lock - 174-9803	190
Lock Kit - 5P-4724	191
Metal Storage Boxes with Hinged Lids and Socket Trays	191
Plastic Tool Box - 202-8643	191
Case and Dividers	191
Plastic Storage Cases with Hinged Lids	192
Foam Block for Plastic Storage Cases	192
Plastic Divided Utility Boxes with Hinged Lids	193
Protector Cases - Pelican Line.....	194

Tool Sets — Hand Tool Sets

Serviceman's Tool Set, 117 Piece Set - 8T-0460

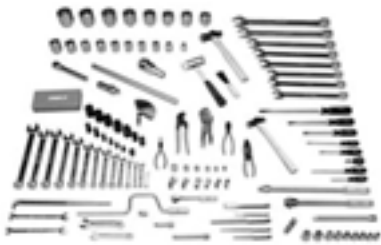

Warranty: See individual part number

- Ideal for servicemen apprentices and shop mechanics
- Large assortment of 3/8 inch, 1/2 inch and 3/4 inch drive tools, 1/4 inch to 1 5/8 inch wrenches, pliers, punches, hammers and screwdrivers
- Designed for use on heavy equipment
- See 8T-0461 Serviceman's Tool Set, 95 Piece, for a similar but smaller set of tools; 8T-0461 contains complete groups of 1/4 inch, 3/8 inch and 1/2 inch drive tools
- Individual hand tools within the group have a lifetime warranty
- Tool box must be ordered separately

Part Number	Description	Size
8T-0460	Serviceman's Tool Set (117 piece tool set)	—
3/8 inch Drive Tools		
239-6824	Reversible Ratchet, 3/8 in Drive	3/8 in
8H-8562	Universal Socket	7/16 in
8H-8563	Universal Socket	1/2 in
8H-8564	Universal Socket	9/16 in
8H-8565	Universal Socket	5/8 in
8H-8566	Universal Socket	3/4 in
8H-8567	Socket	7/16 in
8H-8568	Socket	1/2 in
8H-8569	Socket	9/16 in
8H-8570	Socket	5/8 in
8H-8571	Socket	3/4 in
8H-8573	Speeder Handle	3/8 in
8H-8574	Socket Extension	76.2 mm (3.00 in) long
8H-8575	Extension Assembly	152.4 mm (6.00 in) long
8H-8576	Adapter	3/8 in Female to 1/2 in Male
8S-2274	Socket	3/8 in
8S-2284	Universal Socket	3/8 in
1/2 inch Drive Tools		
168-0383	Breaker Bar	1/2 in
1S-0259	Socket	1/2 in
239-6826	Reversible Ratchet	1/2 in
8H-8549	Socket	9/16 in
8H-8550	Socket	5/8 in
8H-8551	Socket	11/16 in
8H-8552	Socket	3/4 in
8H-8553	Socket	13/16 in
8H-8554	Socket	7/8 in

Tool Sets — Hand Tool Sets

Serviceman's Tool Set, 117 Piece Set - 8T-0460 (Cont'd.)

Part Number	Description	Size
8H-8555	Socket	15/16 in
8H-8556	Socket, 1 in	1 in
8H-8559	Socket Extension	1/2 in drive, 254.0 mm (10.00 in) long
8H-8560	Universal Joint	1/2 in
8H-8561	Adapter	1/2 in Female to 3/4 in Male
3/4 inch Drive Tools		
160-6389	Reversible Ratchet Head	3/4 in
162-8716	Ratchet Head Handle	—
8H-8504	Socket	2 1/4 in
8H-8529	Socket	3/4 in
8H-8530	Socket	7/8 in
8H-8531	Socket	15/16 in
8H-8532	Socket	1 in
8H-8533	Socket	1 1/16 in
8H-8534	Socket	1 1/8 in
8H-8535	Socket	1 1/4 in
8H-8536	Socket	1 5/16 in
8H-8537	Socket	1 1/2 in
8H-8538	Socket	1 11/16 in
8H-8539	Socket	1 5/8 in
8H-8540	Socket	1 3/4 in
8H-8541	Socket	1 7/8 in
8H-8542	Socket	2 in
8H-8543	Socket	2 1/8 in
8H-8544	Socket	2 3/16 in
8H-8546	Breaker Bar Head	3/4 in
8H-8548	Socket Extension	203.2 mm (8.00 in) long
Combination Wrenches		
1S-0253	Combination Wrench	3/4 in (short)
1S-0254	Combination Wrench	9/16 in (short)
4C-9592	Combination Wrench	3/8 in
4C-9593	Combination Wrench	7/16 in
4C-9594	Wrench, 1/2 in (low idle adjustment)	1/2 in
4C-9595	Combination Wrench	9/16 in
4C-9596	Combination Wrench	5/8 in
4C-9597	Combination Wrench	11/16 in
4C-9598	Combination Wrench	3/4 in
4C-9599	Combination Wrench	13/16 in
4C-9601	Combination Wrench	7/8 in
4C-9602	Combination Wrench	15/16 in
4C-9603	Combination Wrench	1 in
4C-9604	Combination Wrench	1 1/4 in

Tool Sets — Hand Tool Sets

Serviceman's Tool Set, 117 Piece Set - 8T-0460 (Cont'd.)

Part Number	Description	Size
4C-9605	Combination Wrench	5/16 in
8H-8423	Combination Wrench	1 5/8 in
8H-8424	Combination Wrench	1 1/2 in
8H-8501	Open End Tappet Wrench	1/2 in x 9/16 in
8H-8516	Combination Wrench	1 1/16 in
8H-8517	Combination Wrench	1 1/8 in
8H-8518	Combination Wrench	1 1/4 in
8H-8519	Combination Wrench	1 5/16 in
8H-8520	Combination Wrench	1 3/8 in (short)
Sockets Designed for 12 Point Shoulder Bolts		
8S-1589	Shoulder Bolt Socket, 12 point	1/4 in
8S-1590	Shoulder Bolt Socket, 12 point	5/16 in
8S-1591	Socket	3/8 in
8S-1592	Socket	7/16 in
8S-1593	Socket	1/2 in
8S-1594	Socket	9/16 in
8S-1595	Socket	5/8 in
8S-1596	Socket	11/16 in
8S-1597	Socket	3/4 in
8S-1598	Socket	13/16 in
8S-1599	Socket	7/8 in
8S-1600	Socket	15/16 in
8S-1601	Socket	1 in
Pliers, Punches, Screwdrivers and Hammers		
1F-1159	Center Punch	3/16 in, 152.4 mm (6.00 in) long
1F-1161	Chisel	3/4 in Edge, 177.8 mm (7.00 in) long
1S-0257	Ball Peen Hammer, 0.34 kg (12 oz)	1 1/8 in, 340.2 g (12 oz)
1S-0258	Soft Face Hammer (Serviceable parts of the hammer, 1 Medium Tip 3S-0460, 1 Hard Tip 3S-0459)	1 11/16 in, 907.2 g (32 oz)
277-8790	Plastic Handle Screwdriver	1/2 in tip, 469 mm (18.47 in) long
316-0706	Locking Pliers	254 mm (10.00 in)
5F-4764	Rolling Head Pry Bar, 40.64 cm (16 in)	406.4 mm (16.00 in) long
6V-6192	Slip Joint Pliers	208 mm (8 in)
6V-6193	Diagonal Cutting Pliers, 44.45 cm (17 1/2 in)	185.67 mm (7.31 in)
6V-6194	Needle Nose Pliers	181.1 mm (7.13 in)
6V-6195	Interlocking Joint Pliers	234.7 mm (9.25 in)
6V-7932	Standard Screwdriver	3/8 in tip, 342.1 mm (13.47 in) long
6V-7933	Standard Screwdriver	5/16 in tip, 277.11 mm (10.91 in) long
6V-7934	Phillips Screwdriver	No. 2 Phillips tip, 213.6 mm (8.41 in) long
6V-7935	Standard Screwdriver	1/4 in tip, 212.85 mm (8.38 in) long

Tool Sets — Hand Tool Sets

Serviceman's Tool Set, 117 Piece Set - 8T-0460 (Cont'd.)

Part Number	Description	Size
6V-7936	Phillips Screwdriver	No. 1 Phillips tip, 162.9 mm (6.66 in) long
6V-7937	Standard Screwdriver	239.78 mm (9.44 in) long
6V-7938	Screwdriver	1/4 in tip, 100.1 mm (3.94 in) long
8H-8577	Ball Peen Hammer	2 lb, 1 1/4 in
8H-8578	Punch	3/8 in Point, 241.3 mm (9.50 in) long
8H-8579	Punch	5/32 in Point, 203.2 mm (8.00 in) long
8H-8580	Scraper	38.1 mm (1.50 in) wide
8H-8581	Feeler Gauge	25 Blade, .0015 in - .025 in

Serviceman's Tool Set, 95 Piece Set - 8T-0461

Warranty: See individual part number



- Similar to 8T-0460 Serviceman's Tool Set, except in drive tools
- 8T-0461 set contains complete groups of 1/4 inch, 3/8 inch and 1/2 inch drive tools; whereas the 8T-0460 set contains 3/8 inch, 1/2 inch and 3/4 inch drive tools
- Individual hand tools within the group have a Lifetime Warranty; hand tools within a group will be warranted when necessary
- Tool box must be ordered separately

Part Number	Description	Size
8T-0461	Serviceman's Tool Group (full 95 piece set)	—
1/4 inch Drive Tools		
239-6823	Reversible Ratchet	1/4 in
9S-1711	Socket	3/16 in
9S-1712	Socket	7/32 in
9S-1713	Socket	1/4 in
9S-1714	Socket	9/32 in
9S-1715	Socket	5/16 in
9S-1716	Socket	11/32 in
9S-1717	Socket	3/8 in
9S-1718	Socket	7/16 in
9S-1719	Socket	1/2 in
9S-1720	Socket Extension	50.8 mm (2.00 in)
9S-1721	Extension	101.6 mm (4.00 in)
9S-1722	Socket Driver	1/4 in

Tool Sets — Hand Tool Sets

Serviceman's Tool Set, 95 Piece Set - 8T-0461 (Cont'd.)

Part Number	Description	Size
9S-1724	Universal Joint	1/4 in
9S-1725	Case	—
9S-2573	Socket, Deep Length	3/8 in
3/8 inch Drive Tools		
239-6824	Reversible Ratchet, 3/8 in Drive	3/8 in
8H-8562	Universal Socket	7/16 in
8H-8563	Universal Socket	1/2 in
8H-8564	Universal Socket	9/16 in
8H-8565	Universal Socket	5/8 in
8H-8566	Universal Socket	3/4 in
8H-8567	Socket	7/16 in
8H-8568	Socket	1/2 in
8H-8569	Socket	9/16 in
8H-8570	Socket	5/8 in
8H-8571	Socket	3/4 in
8H-8573	Speeder Handle	3/8 in
8H-8574	Socket Extension	76.2 mm (3.00 in) long
8H-8575	Extension Assembly	152.4 mm (6.00 in) long
8H-8576	Adapter	3/8 in Female to 1/2 in Male
8S-1589	Shoulder Bolt Socket, 12 point	1/4 in
8S-1590	Shoulder Bolt Socket, 12 point	5/16 in
8S-2274	Socket	3/8 in
8S-2284	Universal Socket	3/8 in
9S-1727	Universal Socket	11/16 in
9S-1728	Socket	11/16 in
1/2 inch Drive Tools		
168-0383	Breaker Bar	1/2 in
1S-0259	Socket	1/2 in
239-6826	Reversible Ratchet	1/2 in
8H-8549	Socket	9/16 in
8H-8550	Socket	5/8 in
8H-8551	Socket	11/16 in

Tool Sets — Hand Tool Sets

Serviceman's Tool Set, 95 Piece Set - 8T-0461 (Cont'd.)

Part Number	Description	Size
8H-8552	Socket	3/4 in
8H-8553	Socket	13/16 in
8H-8554	Socket	7/8 in
8H-8555	Socket	15/16 in
8H-8556	Socket, 1 in	1 in
8H-8559	Socket Extension	1/2 in drive, 254.0 mm (10.00 in) long
9S-1729	Socket	1 1/16 in
9S-1730	Socket	1 1/8 in
9S-1731	Socket	1 1/4 in
9S-1732	Extension, 127 mm (5.0 in) Long (1/2 in Drive)	1/2 in drive, 127.0 mm (5.00 in) long
Combination Wrenches		
1S-0254	Combination Wrench	9/16 in (short)
4C-9592	Combination Wrench	3/8 in
4C-9593	Combination Wrench	7/16 in
4C-9594	Wrench, 1/2 in (low idle adjustment)	1/2 in
4C-9595	Combination Wrench	9/16 in
4C-9596	Combination Wrench	5/8 in
4C-9597	Combination Wrench	11/16 in
4C-9598	Combination Wrench	3/4 in
4C-9599	Combination Wrench	13/16 in
4C-9601	Combination Wrench	7/8 in
4C-9602	Combination Wrench (2)	15/16 in
4C-9603	Combination Wrench	1 in
4C-9604	Combination Wrench	1/4 in
4C-9605	Combination Wrench	5/16 in
8H-8501	Open End Tappet Wrench (2)	1/2 in x 9/16 in
Pliers, Punches, Screwdrivers and Hammers		
1F-1159	Center Punch	3/16 in, 152.4 mm (6.00 in) long
1F-1161	Chisel	3/4 in Edge, 177.8 mm (7.00 in) long
1S-0257	Ball Peen Hammer, 0.34 kg (12 oz)	1 1/8 in, 340.2 g (12 oz)
1S-0258	Soft Face Hammer (Serviceable parts of the hammer, 1 Medium Tip 3S-0460, 1 Hard Tip 3S-0459)	1 11/16 in, 907.2 g (32 oz)

Tool Sets — Hand Tool Sets

Serviceman's Tool Set, 95 Piece Set - 8T-0461 (Cont'd.)

Part Number	Description	Size
208-6183	Hacksaw	419.0 mm (16.50 in) long
316-0706	Locking Pliers	254 mm (10.00 in)
5F-4764	Rolling Head Pry Bar, 40.64 cm (16 in)	406.4 mm (16.00 in) long
6V-6192	Slip Joint Pliers	208 mm (8 in)
6V-6193	Diagonal Cutting Pliers, 44.45 cm (17 1/2 in)	185.67 mm (7.31 in)
6V-6194	Needle Nose Pliers	181.1 mm (7.13 in)
6V-6195	Interlocking Joint Pliers	234.7 mm (9.25 in)
6V-7932	Standard Screwdriver	3/8 in tip, 342.1 mm (13.47 in) long
6V-7933	Standard Screwdriver	5/16 in tip, 277.11 mm (10.91 in) long
6V-7934	Phillips Screwdriver	No. 2 Phillips tip, 213.6 mm (8.41 in) long
6V-7935	Standard Screwdriver	1/4 in tip, 212.85 mm (8.38 in) long
6V-7936	Phillips Screwdriver	No. 1 Phillips tip, 162.9 mm (6.66 in) long
6V-7937	Standard Screwdriver	239.78 mm (9.44 in) long
8H-8578	Punch	3/8 in Point, 241.3 mm (9.50 in) long
8H-8579	Punch	5/32 in Point, 203.2 mm (8.00 in) long
8H-8580	Scraper	38.1 mm (1.50 in) wide
8H-8581	Feeler Gauge	25 Blade, .0015 in - .025 in
9S-1742	Hex Key Wrench Assembly	9 bits: .05 in, 1/16 in, 5/64 in, 3/32 in, 7/64 in, 1/8 in, 9/64 in, 5/32 in, 3/16 in
9S-1743	Ferrule Nut Wrench	3/4 in and 1 in

Student Tool Set - 222-7876

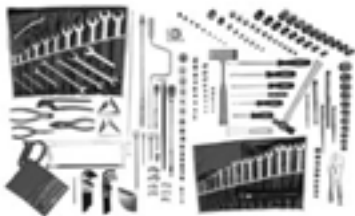

Warranty: See individual part number

- A specially selected set of basic hand tools for students in the Caterpillar Model Dealer Service Technician Program
- Premier quality tools for the work done in the classroom and on the job
- Over 200 tools

Part Number	Description
222-7876	Complete Student Tool Set
146-2728	Flex Pickup Tool
194-3574	3/8 Drive, 12 Point Metric Socket Set, 12-piece

Part Number	Description
194-3576	Metric Socket Set
194-3578	Metric Socket Set
194-3584	Torx Socket Set

Tool Sets — Hand Tool Sets

Student Tool Set - 222-7876 (Cont'd.)

Part Number	Description
194-3585	Hex Bit Socket Set
199-6156	Metric Socket Set
199-9019	Metric Socket Set
1U-5545	Combination Wrench Set
1U-7321	Flashlight
200-1931	Metric Hex Key Set
200-8413	Metric Socket Set
293-3025	Fractional Ball-end Hex Wrench Set

Part Number	Description
293-3026	Metric Ball-end Hex Wrench Set
2P-5490	Deep Well Socket Set
396-2007	Safety Glasses
5P-1720	Seal Pick
5P-3277	Tape
5P-3920	Rule - Steel
8T-0461	Serviceman's Tool Group (full 95 piece set)

Hand Tool Set - 211-0616



Warranty: See individual part number

- For performing routine adjustment and maintenance of all Track-Type Tractors, Track-Type Loaders and Engines

Part Number	Description	Size
211-0616	Hand Tool Set ⁽¹⁾	
185-3630	Filter Strap Wrench Assm. ⁽¹⁾	—
1S-0259	Socket	1/2 in, 1/2 in drive, 12 Pt.
211-0136	Cat Tool Bag (not shown) ⁽¹⁾	—
212-8144	Petcock Socket	1/2 in drive
212-8145	Drain Plug Socket ⁽¹⁾	1/2 in Female, 3/4 in Male
213-1983	Combination Pliers	167.0 mm (6.60 in) long
239-6826	Reversible Ratchet	1/2 in
4C-9592	Combination Wrench	3/8 in
4C-9594	Wrench, 1/2 in (low idle adjustment)	1/2 in
4C-9595	Combination Wrench	9/16 in
4C-9596	Combination Wrench	5/8 in
4C-9598	Combination Wrench	3/4 in
4C-9601	Combination Wrench	7/8 in
4C-9603	Combination Wrench	1 in

Part Number	Description	Size
4C-9605	Combination Wrench	5/16 in
5F-4764	Rolling Head Pry Bar, 40.64 cm (16 in) ⁽¹⁾	406.4 mm (16.00 in) long
6V-7934	Phillips Screwdriver	No. 2 Phillips tip, 213.6 mm (8.41 in) long
6V-7935	Standard Screwdriver	Standard 1/4 in tip, 212.85 mm (8.38 in) long
8F-9866	Cat Pro "L" Grease Gun ⁽¹⁾	
8H-8549	Socket	9/16 in, 1/2 in drive, 12 Pt.
8H-8554	Socket	7/8 in, 1/2 in drive, 12 Pt.
8H-8555	Socket	15/16 in, 1/2 in drive, 12 Pt.
8H-8556	Socket, 1 in	1 in, 1/2 in drive, 12 Pt.
8H-8559	Socket Extension	1/2 in drive, 254.0 mm (10.00 in) long
8H-8581	Feeler Gauge ⁽¹⁾	25 blade, .0015 in to .025 in
9S-1730	Socket	1 1/8 in, 1/2 in drive, 12 Pt
9S-1732	Extension – 127 mm (5.0 in) Long (1/2 in Drive)	1/2 in drive, 127.0 mm (5.0 in) long

¹ Warranty: Six Months

Tool Sets — Hand Tool Sets

Hand Tool Set - 211-0617



Warranty: See individual part number

- For routine maintenance and adjustment of all rubber-tired machines (Wheel Loaders, Motor Graders, Skidders, Solid Frame Off Highway Trucks, Wheel Tractors, Backhoe Loaders and Integrated Toolcarriers)

Part Number	Description	Size
211-0617	Hand Tool Set ⁽²⁾	
185-3630	Filter Strap Wrench Assm. ⁽³⁾	—
1P-0545	Tire Pressure Gauge Group	
1S-0259	Socket	1/2 in, 1/2 in drive, 12 Pt.
212-8144	Petcock Socket	1/2 in drive
212-8145	Drain Plug Socket ⁽³⁾	1/2 in Female, 3/4 in Male
213-1985	Sliding T-Handle	1/2 in drive, 304.8 mm (12.00 in) long
4C-9592	Combination Wrench	3/8 in
4C-9594	Wrench, 1/2 in (low idle adjustment)	1/2 in
4C-9595	Combination Wrench	9/16 in
4C-9596	Combination Wrench	5/8 in
4C-9597	Combination Wrench	11/16 in
4C-9598	Combination Wrench	3/4 in
4C-9605	Combination Wrench	5/16 in
5F-4764	Rolling Head Pry Bar, 40.64 cm (16 in) ⁽³⁾	406.4 mm (16.00 in) long
6V-7932	Standard Screwdriver	3/8 in tip, 342.1 mm

Part Number	Description	Size
		(13.47 in) long
6V-7934	Phillips Screwdriver	No. 2 Phillips tip, 213.6 mm (8.41 in) long
8F-9866	Cat Pro "L" Grease Gun ⁽³⁾	
8H-8536	Socket	1 5/16 in, 3/4 in drive, 12 Pt.
8H-8537	Socket	1 1/2 in, 3/4 in drive, 12 Pt.
8H-8538	Socket	1 11/16 in, 3/4 in drive, 12 Pt.
8H-8541	Socket	1 7/8 in, 3/4 in drive, 12Pt.
8H-8549	Socket	9/16 in, 1/2 in drive, 12 Pt.
8H-8551	Socket	11/16 in, 1/2 in drive, 12 Pt.
8H-8552	Socket	3/4 in, 1/2 in drive, 12 Pt.
8H-8553	Socket	13/16 in, 1/2 in drive, 21 Pt.
8H-8554	Socket	7/8 in, 1/2 in drive, 12 Pt.
8H-8555	Socket	15/16 in, 1/2 in drive, 12 Pt.
8H-8559	Socket Extension	1/2 in drive, 254.0 mm (10.00 in) long
8H-8581	Feeler Gauge ⁽³⁾	25 blade, .0015 in to .025 in
9S-1730	Socket	1 1/8 in, 1/2 in drive, 12 Pt
9S-1731	Socket	1 1/4 in, 1/2 in drive, 12 Pt.

Hand Tool Set - 214-6153



Warranty: See individual part number

- Use for routine maintenance adjustments on rear engine Track-Type Loaders such as the 943, 953, 963 and 973

² Warranty: Lifetime
³ Warranty: Six Months

Tool Sets — Hand Tool Sets

Hand Tool Set - 214-6153 (Cont'd.)

Part Number	Description	Size	Part Number	Description	Size
214-6153	Hand Tool Group ⁽⁴⁾	—	6V-7935	Standard Screwdriver	1/4 in tip, 212.85 mm (8.38 in) long
185-3630	Filter Strap Wrench Assm. ⁽⁵⁾	—	8F-9866	Cat Pro "L" Grease Gun ⁽⁵⁾	
211-0136	Cat Tool Bag (not shown) ⁽⁵⁾	610.0 mm x 203.0 mm x 159.0 mm (24.00 in x 8.00 in x 6.25 in)	8H-8549	Socket	9/16 in
212-8144	Petcock Socket	1/2 in square	8H-8552	Socket	3/4 in
213-1983	Combination Pliers	167.0 mm (6.60 in) long	8H-8554	Socket	7/8 in
239-6826	Reversible Ratchet	1/2 in	8H-8556	Socket, 1 in	1 in
4C-9594	Wrench, 1/2 in (low idle adjustment)	1/2 in	8H-8559	Socket Extension	1/2 in drive, 254.0 mm (10.00 in) long
4C-9595	Combination Wrench	9/16 in	9U-7419	Bit, 19.05 mm (3/4 in)	—
4C-9598	Combination Wrench	3/4 in			
5F-4764	Rolling Head Pry Bar, 40.64 cm (16 in) ⁽⁵⁾	406.4 mm (16.00 in) long			

Hand Tool Set - 214-7318



All 300 Series Excavators
Warranty: See individual part number

- Used for routine maintenance and adjustment
- Flat top tool box provides adequate storage for all tools in this group
- Using proper tools reduces downtime

Part Number	Description	Size	Part Number	Description	Size
214-7318	Complete Hand Tool Group ⁽⁶⁾	—	1U-7569	Hex Wrench	14 mm
185-3630	Filter Strap Wrench Assm. ⁽⁷⁾	—	1U-7585	Hex Wrench	5/8 in
194-3535	Socket, Assembly, T30	—	213-6926	Impact Socket (1/2 in Drive)	10.0 mm, 1/2 in drive, 6 Pt.
194-3538	Socket, Assembly, T50	—	213-6927	Impact Socket (1/2 in Drive)	11.0 mm, 1/2 in drive, 6 Pt.
194-3565	Socket	30 mm, 1/2 in drive, 12 Pt.	213-6929	Impact Socket (1/2 in Drive)	13.0 mm, 1/2 in drive. 6 Pt.
199-6154	Socket (1/2 in Drive)	24 mm, 1/2 in drive, 12 Pt.	214-7222	Combination Wrench	32.0 mm
1U-7563	Hex Wrench, 4 mm	4 mm	214-7223	Combination Wrench	36.0 mm
1U-7564	Hex Wrench, 5 mm	5 mm	214-7329	Open End Wrench	41.0 mm
1U-7565	Allen Key	6 mm	214-7330	Adjustable Wrench	12.00 in, 1 5/16 jaw range
1U-7566	Hex Wrench	8 mm	239-6826	Reversible Ratchet	1/2 in
1U-7567	Hex Wrench	10 mm			

- 4 Warranty: Lifetime
5 Warranty: Six Months
6 Warranty: Lifetime
7 Warranty: Six Months

Tool Sets — Hand Tool Sets

Hand Tool Set - 214-7318 (Cont'd.)

Part Number	Description	Size	Part Number	Description	Size
5F-4764	Rolling Head Pry Bar, 40.64 cm (16 in) ⁽⁸⁾	406.4 mm (16.00 in) long	6V-9112	Socket (1/2 in Drive)	17.0 mm, 1/2 in drive, 12 Pt.
6V-6192	Slip Joint Pliers	208 mm (8 in)	6V-9113	Socket (1/2 in Drive)	18.0 mm, 1/2 in drive, 12 Pt.
6V-7932	Standard Screwdriver	3/8 in tip, 342.1 mm (13.47 in) long	6V-9116	Socket (1/2 in Drive)	22.0 mm, 1/2 in drive, 12 Pt.
6V-9096	Wrench	16.0 mm	8F-9866	Cat Pro "L" Grease Gun ⁽⁸⁾	
6V-9098	Wrench	18.0 mm	8H-8424	Combination Wrench	1 1/2 in
6V-9099	Wrench	19.0 mm	8H-8577	Ball Peen Hammer ⁽⁸⁾	2 lb, 1 1/4 in
6V-9101	Combination Wrench	21.0 mm	8H-8581	Feeler Gauge ⁽⁸⁾	25 Blade, .0015 in - .025 in
6V-9102	Combination Wrench	22.0 mm	9S-1732	Extension – 127 mm (5.0 in) Long (1/2 in Drive)	1/2 in drive, 127.0 mm (5.00 in) long
6V-9103	Combination Wrench	24.0 mm	9U-6219	Tool Box	–
6V-9104	Combination Wrench	30.0 mm	9U-7968	Pry Bar ⁽⁹⁾	–
6V-9111	Socket (1/2 in Drive)	16.0 mm, 1/2 in drive, 12 Pt.			

Hand Tool Set - 214-7219

Warranty: See individual part number

- For routine maintenance and adjustments



Part Number	Description	Size
214-7219	Complete Hand Tool Group ⁽¹⁰⁾	–
185-3630	Filter Strap Wrench Assm. ⁽¹¹⁾	–
213-1985	Sliding T-Handle	1/2 in drive, 304.8 mm (12.00 in) long
4C-9592	Combination Wrench	3/8 in
4C-9595	Combination Wrench	9/16 in
4C-9598	Combination Wrench	3/4 in
5F-4764	Rolling Head Pry Bar, 40.64 cm (16 in)	406.4 mm (16.00 in) long
8F-9866	Cat Pro "L" Grease Gun ⁽¹¹⁾	
8H-8549	Socket	9/16 in
8H-8556	Socket, 1 in	1 in
8H-8559	Socket Extension	1/2 in drive, 254.0 mm (10.00 in) long
8H-8581	Feeler Gauge ⁽¹¹⁾	25 Blade, .0015 in - .025 in

8 Warranty: Six Months

9 Warranty: Lifetime

10 Warranty: Lifetime

11 Warranty: Six Months

Hand Tool Set - 157-0674



Model: 972G Wheel Loader

Warranty: See individual part number

- Used to perform routine maintenance and adjustment
- Twenty six (26) individual hand tools
- Metric wrenches and sockets accommodate fasteners and fittings on wheel loader
- Reduce downtime by using proper tools

Part Number	Description	Size
157-0674	Complete Hand Tool Group ⁽¹²⁾	—
162-8716	Ratchet Head Handle	—
185-3630	Filter Strap Wrench Assm. ⁽¹³⁾	—
199-6150	Socket (1/2 in Drive)	13.0 mm
199-6154	Socket (1/2 in Drive)	24 mm, 1/2 in drive, 12 Pt.
1P-0545	Tire Pressure Gauge Group	—
1U-5548	Wrench, 8 mm (high idle adjustment)	8.0 mm
212-8144	Petcock Socket	1/2 in square
212-8145	Drain Plug Socket ⁽¹³⁾	1/2 in Female, 3/4 in Male
213-1985	Sliding T-Handle	1/2 in drive, 304.8 mm (12.00 in) long
5F-4764	Rolling Head Pry Bar, 40.64 cm (16 in) ⁽¹³⁾	406.4 mm (16.00 in) long
6V-7932	Standard Screwdriver	3/8 in tip, 342.1 mm (13.47 in) long
6V-7934	Phillips Screwdriver	No. 2 Phillips tip, 213.6 mm (8.41 in) long
6V-9090	Wrench	10.0 mm
6V-9093	Wrench	13.0 mm
6V-9097	Wrench	17.0 mm
6V-9099	Wrench	19.0 mm
6V-9112	Socket (1/2 in Drive)	17.0 mm, 1/2 in drive, 12 Pt.
6V-9114	Socket (1/2 in Drive)	19.0 mm
6V-9116	Socket (1/2 in Drive)	22.0 mm, 1/2 in drive, 12 Pt.
6V-9118	Socket	30 mm
6V-9119	Socket	36 mm
6V-9120	Socket	46 mm
8F-9866	Cat Pro "L" Grease Gun ⁽¹³⁾	
8H-8546	Breaker Bar Head	3/4 in
8H-8548	Socket Extension	203.2 mm (8.00 in) long
8H-8559	Socket Extension	1/2 in drive, 254.0 mm (10.00 in) long
8H-8581	Feeler Gauge ⁽¹³⁾	25 Blade, .0015 in - .025 in

¹² Warranty: Lifetime

¹³ Warranty: Six Months

Tool Sets — Hand Tool Sets

Hand Tool Set - 207-1515



Warranty: Lifetime unless otherwise noted

- Basic maintenance tool group
- Contains 21 individual hand tools
- Includes canvas bag for storing or transporting tools
- Warranty: Canvas bag, grease gun, and strap wrench assembly have a 6 month warranty; all other hand tools have a lifetime warranty

Part Number	Description	Size
207-1515	Hand Tool Set	—
185-3630	Filter Strap Wrench Assm. ⁽¹⁴⁾	—
1U-7563	Hex Wrench, 4 mm	4 mm
1U-7564	Hex Wrench, 5 mm	5 mm
1U-7565	Allen Key	6 mm
1U-7566	Hex Wrench	8 mm
1U-7567	Hex Wrench	10 mm
1U-7569	Hex Wrench	14 mm
1U-7585	Hex Wrench	5/8 in
239-6826	Reversible Ratchet	1/2 in
5F-4764	Rolling Head Pry Bar, 40.64 cm (16 in) ⁽¹⁴⁾	406.4 mm (16.00 in) long
6V-7933	Standard Screwdriver	5/16 in tip, 277.11 mm (10.91 in) long
6V-7934	Phillips Screwdriver	No. 2 Phillips tip, 213.6 mm (8.41 in) long
6V-9096	Wrench	16.0 mm
6V-9098	Wrench	18.0 mm
6V-9099	Wrench	19.0 mm
6V-9101	Combination Wrench	21.0 mm
6V-9102	Combination Wrench	22.0 mm
6V-9103	Combination Wrench	24.0 mm
8F-9866	Cat Pro "L" Grease Gun ⁽¹⁴⁾	
8H-8581	Feeler Gauge ⁽¹⁴⁾	25 Blade, .0015 in - .025 in
9S-1732	Extension – 127 mm (5.0 in) Long (1/2 in Drive)	1/2 in drive, 127.0 mm (5.00 in) long

Hand Tool Set - 256-4816

Warranty: See individual part number

- Used for routine maintenance and adjustment
- Flat top tool box provides adequate storage for all tools in this group
- Using proper tools reduces downtime

Part Number	Description	Size
256-4816	Hand Tool Set ⁽¹⁴⁾	—
185-3630	Filter Strap Wrench Assm. ⁽¹⁴⁾	—
194-3565	Socket	30 mm, 1/2 in drive, 12 Pt.

¹⁴ Warranty: Six Months

Tool Sets — Hand Tool Sets

Hand Tool Set - 256-4816 (Cont'd.)

Part Number	Description	Size
199-6154	Socket (1/2 in Drive)	24 mm, 1/2 in drive, 12 Pt.
1U-7563	Hex Wrench, 4 mm	4 mm
1U-7564	Hex Wrench, 5 mm	5 mm
1U-7565	Allen Key	6 mm
1U-7566	Hex Wrench	8 mm
1U-7567	Hex Wrench	10 mm
1U-7569	Hex Wrench	14 mm
1U-7585	Hex Wrench	5/8 in
200-1929	Metric Hex Key Set	1.5 mm, 2.0 mm, 2.5 mm, 3.0 mm, 4.0 mm, 5.0 mm, 6.0 mm, 8.0 mm, and 10.0 mm
213-6926	Impact Socket (1/2 in Drive)	10.0 mm, 1/2 in drive, 6 Pt.
213-6927	Impact Socket (1/2 in Drive)	11.0 mm, 1/2 in drive, 6 Pt.
213-6929	Impact Socket (1/2 in Drive)	13.0 mm, 1/2 in drive. 6 Pt.
214-7223	Combination Wrench	36.0 mm
214-7322	Adjustable Wrench	8 in
214-7324	Torx [®] Bit Set	–
214-7329	Open End Wrench	41.0 mm
239-6826	Reversible Ratchet	1/2 in
256-4879	Torx Wrench, T50	–
6V-7932	Standard Screwdriver	3/8 in tip, 342.1 mm (13.47 in) long
6V-9096	Wrench	16.0 mm
6V-9098	Wrench	18.0 mm
6V-9099	Wrench	19.0 mm
6V-9101	Combination Wrench	21.0 mm
6V-9102	Combination Wrench	22.0 mm
6V-9103	Combination Wrench	24.0 mm
6V-9104	Combination Wrench	30.0 mm
6V-9111	Socket (1/2 in Drive)	16.0 mm, 1/2 in drive, 12 Pt.
6V-9113	Socket (1/2 in Drive)	18.0 mm, 1/2 in drive, 12 Pt.
6V-9116	Socket (1/2 in Drive)	22.0 mm, 1/2 in drive, 12 Pt.
8F-9866	Cat Pro "L" Grease Gun ⁽¹⁵⁾	
8H-8577	Ball Peen Hammer ⁽¹⁵⁾	2 lb, 1 1/4 in
9S-1732	Extension – 127 mm (5.0 in) Long (1/2 in Drive)	1/2 in drive, 127.0 mm (5.00 in) long
9U-6219	Tool Box	–
9U-7968	Pry Bar ⁽¹⁶⁾	–

15 Warranty: Six Months

16 Warranty: Lifetime

Tool Sets — Field Tool Sets

Field Tool Set - 133-8877



416C, 426C, 436C, 428C, and 438C Backhoe Loaders

Warranty: See individual part number

- Used to perform routine maintenance and adjustment operations on C-series Backhoe Loaders
- Group includes 20 required hand tools
- Features both English and Metric wrenches and sockets
- Includes "T" handle wrench and extension for wheel lug removal and installation
- Canvas bag provides adequate storage even in limited space

Part Number	Description	Wrench Sizes	Socket Sizes	T-Handles	Extension	Screwdrivers	Pliers	Socket
133-8877	Field Tool Group ⁽¹⁾	7/16 in, 1/2 in, 13/16 in, 7/8 in, 15/16 in (English); 14.0 mm, 17.0 mm (Metric)	15/16 in, 17.0mm (English and Metric 1/2 in drive)	1/2 in and 3/4 in drive	3/4 in drive	No. 2 Phillips and 1/4 in flat	1 slip joint, 1 retaining ring	3/8 in drive, T30 Torx Bit
Group Also Contains:								
185-3630	Filter Strap Wrench Assm. (2)	—	—	—	—	—	—	—
8F-9866	Cat Pro "L" Grease Gun ⁽²⁾	—	—	—	—	—	—	—

Field Tool Set - 144-4674



914G, 924F and 928G Wheel Loaders

Warranty: See individual part number

- Used to perform routine maintenance and adjustment operations
- Group contains 25 individual hand tools
- Features both English and metric wrenches and sockets
- Includes Cat grease gun, filter wrench and tire pressure gauge
- Canvas bag provides adequate storage even in limited space

Field Tool Set 144-4674 Includes:

Cat Tool Bag

Part Number	Description	Size	Part Number	Description	Size
144-4674	Complete Field Tool Group		213-1983	Slip Joint Pliers	—
185-3630	Filter Strap Wrench Assm.	—	239-6824	Drive Ratchet	3/8 in
194-3535	Torx Socket	T30 - 3/8 in	4C-9598	Wrench	3/4 in
194-3538	Torx Socket	T50 - 3/8 in	4C-9599	Wrench	13/16 in
199-9026	Socket	10 mm	6V-7934	No. 2 Phillips	—
199-9029	Socket	13 mm	6V-7935	1/4 Flat Screwdriver	—
199-9032	Socket	16 mm	6V-9090	Wrench	10 mm
199-9035	Socket	19 mm	6V-9093	Wrench	13 mm

1 Warranty: Lifetime

2 Warranty: Six Months

Tool Sets — Field Tool Sets

Field Tool Set - 144-4674 (Cont'd.)

Part Number	Description	Size	Part Number	Description	Size
6V-9096	Wrench	16 mm	8H-8517	Wrench	1 1/8 in
6V-9098	Wrench	18 mm	8H-8520	Wrench	1 3/8 in
6V-9099	Wrench	19 mm	8H-8575	Drive Extension	6 x 3/8 in
8F-9866	Cat Pro "L" Grease Gun		8H-8576	Adapter	3/8 - 1/2 in
8H-8423	Wrench	1 5/8 in	8T-0886	Tire Pressure Gauge	

Field Tool Set - 152-4942



902, 906, and 908 Compact Wheel Loader
 Warranty: See individual part number

- Used to perform routine maintenance and adjustments
- Includes 12 required hand tools
- Includes both English and metric wrenches and screwdrivers
- Roll-up tool pouch provides good storage in limited space

Part Number	Open End Wrenches	Hex Wrench	Screwdrivers	Ball Peen Hammer	Adjustable Wrench	Filter Band Wrench	T-Bar and Sliding Head	Deep Socket
152-4942	10.0, 11.0, 12.0, 13.0, 16.0, 17.0, 18.0, and 19.0 mm (3)	4.0 mm	#2 Phillips and 1/4 in flat tip	6 oz	8.00 in.	3 3/4 in diameter	12.00 in long x 1/2 in square drive	1 1/8 in, 6 point, 1/2 in square drive

Wrenches — Cat Standard Wrenches

Fractional Combination Wrench Set, Standard Length, 11 Piece - 4C-9600



Warranty: Lifetime

- Polished chrome finish
- 271-4700 Wrench Gripper Rack available

Size	Part Number	Description	Length
—	4C-9600	Combination Wrench Set, Standard Length	—
3/8 in	4C-9592	Combination Wrench	165.1 mm (6.50 in)
7/16 in	4C-9593	Combination Wrench	184.2 mm (7.25 in)
1/2 in	4C-9594	Wrench, 1/2 in (low idle adjustment)	204.0 mm (8.03 in)
9/16 in	4C-9595	Combination Wrench	222.3 mm (8.75 in)
5/8 in	4C-9596	Combination Wrench	241.3 mm (9.50 in)
11/16 in	4C-9597	Combination Wrench	260.4 mm (10.25 in)
3/4 in	4C-9598	Combination Wrench	280.2 mm (11.03 in)
13/16 in	4C-9599	Combination Wrench	299.2 mm (11.78 in)
7/8 in	4C-9601	Combination Wrench	318.3 mm (12.53 in)
15/16 in	4C-9602	Combination Wrench	338.1 mm (13.31 in)
1 in	4C-9603	Combination Wrench	357.1 mm (14.06 in)
Wrench Gripper Rack:			
—	271-4700	Wrench Gripper Rack	—

Fractional Short Length Combination Wrench Set, 9 Piece - 4C-9610



Warranty: Lifetime

- Polished chrome finish
- Includes vinyl bag

Size	Part Number	Description	Length
	4C-9610	Short Length Combination Wrench Set	
1/4 in	4C-9604	Combination Wrench	114.3 mm (4.50 in)
5/16 in	4C-9605	Combination Wrench	124.0 mm (4.88 in)
3/8 in	4C-9606	Combination Wrench	132.6 mm (5.22 in)
7/16 in	4C-9607	Combination Wrench	138.2 mm (5.44 in)
1/2 in	4C-9608	Combination Wrench	146.1 mm (5.75 in)
9/16 in	1S-0254	Combination Wrench	165.1 mm (6.50 in)

Wrenches — Cat Standard Wrenches

Fractional Short Length Combination Wrench Set, 9 Piece - 4C-9610 (Cont'd.)

Size	Part Number	Description	Length
5/8 in	4C-9609	Combination Wrench	157.2 mm (6.19 in)
11/16 in	4C-9611	Combination Wrench	167.4 mm (6.59 in)
3/4 in	1S-0253	Combination Wrench	174.8 mm (6.88 in)

Metric Combination Wrench Set, 14 Piece - 1U-5545



Warranty: Lifetime

- Metric, 6.0 mm through 19.0 mm
- Polished chrome finish
- Includes storage pouch

Size	Part Number	Description	Length
—	1U-5545	Combination Wrench Set	—
6.0 mm	1U-5546	Wrench	113 mm (4.45 in)
7.0 mm	1U-5547	Wrench	118 mm (4.65 in)
8.0 mm	1U-5548	Wrench, 8 mm (high idle adjustment)	123 mm (4.84 in)
9.0 mm	1U-5549	Wrench	159 mm (6.26 in)
10.0 mm	6V-9090	Wrench	171 mm (6.73 in)
11.0 mm	6V-9091	Wrench	184 mm (7.24 in)
12.0 mm	6V-9092	Wrench	195 mm (7.68 in)
13.0 mm	6V-9093	Wrench	207 mm (8.15 in)
14.0 mm	6V-9094	Wrench	219 mm (8.62 in)
15.0 mm	6V-9095	Wrench	233 mm (9.17 in)
16.0 mm	6V-9096	Wrench	242 mm (9.53 in)
17.0 mm	6V-9097	Wrench	256 mm (10.08 in)
18.0 mm	6V-9098	Wrench	267 mm (10.51 in)
19.0 mm	6V-9099	Wrench	280 mm (11.02 in)

Wrenches — Cat Standard Wrenches

Metric Combination Wrench Set, 10 Piece - 233-1632



Warranty: Lifetime

- Increased torque — wrench box end contacts the fastener on the flats rather than on the corners, preventing rounding of the fastener and allowing for more torque to be applied
- Concentric or uniform wall thickness on the box end eliminates weak spots while allowing for a thin wall design for greater accessibility
- Continuous arc open end design evenly distributes applied stress over the entire radius of the open end, enhancing the wrench strength and life of the tool
- Long handles for better reach and greater applied torque
- Highly polished nickel/chrome plating — tough nickel for corrosion resistance and chrome plating for wear resistance and a mirror-like finish

Drive	Part Number	Description	Length
—	233-1632	Metric Wrench Set	—
10.0 mm	6V-9090	Wrench	171.0 mm (6.73 in)
11.0 mm	6V-9091	Wrench	184.0 mm (7.24 in)
12.0 mm	6V-9092	Wrench	195.0 mm (7.68 in)
13.0 mm	6V-9093	Wrench	207.0 mm (8.15 in)
14.0 mm	6V-9094	Wrench	219.0 mm (8.62 in)
15.0 mm	6V-9095	Wrench	233.0 mm (9.17 in)
16.0 mm	6V-9096	Wrench	242.0 mm (9.53 in)
17.0 mm	6V-9097	Wrench	256.0 mm (10.08 in)
18.0 mm	6V-9098	Wrench	267.0 mm (10.51 in)
19.0 mm	6V-9099	Wrench	280.0 mm (11.02 in)

Fractional Combination Wrenches

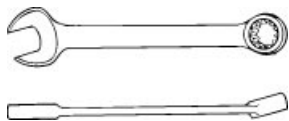

Warranty: Lifetime

- 15° angle on open end and 15° offset on box end
- Box end is 12 point except 8H-8502 which is 6 point
- All are polished chrome finish except 9U-5130

Part Number	Size	Length
1S-0253	3/4 in (short)	174.8 mm (6.88 in)
1S-0254	9/16 in (short)	165.1 mm (6.50 in)
4C-9592	3/8 in	165.1 mm (6.50 in)
4C-9593	7/16 in	184.2 mm (7.25 in)
4C-9594	1/2 in	204 mm (8.03 in)
4C-9595	9/16 in	222.3 mm (8.75 in)
4C-9596	5/8 in	241.3 mm (9.50 in)
4C-9597	11/16 in	260.4 mm (10.25 in)
4C-9598	3/4 in	280.2 mm (11.03 in)
4C-9599	13/16 in	299.2 mm (11.78 in)

Part Number	Size	Length
4C-9601	7/8 in	318.3 mm (12.53 in)
4C-9602	15/16 in	338.1 mm (13.31 in)
4C-9603	1 in	357.1 mm (14.06 in)
4C-9604	1/4 in	114.3 mm (4.50 in)
4C-9605	5/16 in	124 mm (4.88 in)
4C-9606	3/8 in	132.6 mm (5.22 in)
4C-9607	7/16 in	138.2 mm (5.44 in)
4C-9608	1/2 in	146.1 mm (5.75 in)
4C-9609	5/8 in	157.2 mm (6.19 in)
4C-9611	11/16 in	167.4 mm (6.59 in)

Wrenches — Cat Standard Wrenches

Fractional Combination Wrenches (Cont'd.)

Part Number	Size	Length	Part Number	Size	Length
8H-8423	1 5/8 in	562.4 mm (22.14 in)	386-3275	1 3/4 in ⁽²⁾	559 mm (22.01 in)
8H-8424	1 1/2 in	534.5 mm (21.04 in)	386-3277	1 7/8 in	610 mm (24.02 in)
8H-8502 ⁽¹⁾	1/4 in	78.7 mm (3.10 in)	386-3281	2 in	635 mm (25 in)
8H-8516	1 1/16 in	382.8 mm (15.07 in)	386-3279	2 3/16 in	660 mm (25.98 in)
8H-8517	1 1/8 in	404.6 mm (15.93 in)	386-3278	2 1/4 in	686 mm (27.01 in)
8H-8518	1 1/4 in	433.1 mm (17.05 in)	386-3280	2 3/8 in	711 mm (27.99 in)
8H-8519	1 5/16 in	458.5 mm (18.05 in)	386-3352	2 1/2 in	762 mm (30 in)
8H-8520	1 3/8 in (short)	482.6 mm (19 in)	386-3282	3 1/2 in ⁽²⁾	787 mm (30.98 in)
9U-5130 ⁽²⁾	1 13/16 in	596 mm (23.46 in)	386-3283	3 7/8 in ⁽²⁾	978 mm (38.50 in)
386-3276	1 7/16 in ⁽²⁾	483 mm (19.02 in)	386-3284	4 in ⁽²⁾	991 mm (39.02 in)
386-3274	1 11/16 in ⁽²⁾	559 mm (22.01 in)			

Metric Combination Wrenches

Warranty: Lifetime

- 15° angle on open end and 15° offset on box end

Size	Part Number	Length	Size	Part Number	Length
6.0 mm	1U-5546	113.0 mm (4.45 in)	20.0 mm	6V-9100	292.0 mm (11.50 in)
7.0 mm	1U-5547	118.0 mm (4.65 in)	21.0 mm	6V-9101	304.0 mm (11.97 in)
8.0 mm	1U-5548	123.0 mm (4.84 in)	22.0 mm	6V-9102	318.0 mm (12.52 in)
9.0 mm	1U-5549	159.0 mm (6.26 in)	23.0 mm	214-7214	328.0 mm (12.91 in)
10.0 mm	6V-9090	171.0 mm (6.73 in)	24.0 mm	6V-9103	338.0 mm (13.31 in)
11.0 mm	6V-9091	184.0 mm (7.24 in)	25.0 mm	214-7215	356.0 mm (14.02 in)
12.0 mm	6V-9092	195.0 mm (7.68 in)	26.0 mm	214-7217	364.0 mm (14.33 in)
13.0 mm	6V-9093	207.0 mm (8.15 in)	27.0 mm	214-7218	376.0 mm (14.80 in)
14.0 mm	6V-9094	219.0 mm (8.62 in)	29.0 mm	214-7220	395.0 mm (15.55 in)
15.0 mm	6V-9095	233.0 mm (9.17 in)	30.0 mm	6V-9104	414.0 mm (16.30 in)
16.0 mm	6V-9096	242.0 mm (9.53 in)	32.0 mm	214-7222	433.0 mm (17.05 in)
17.0 mm	6V-9097	256.0 mm (10.08 in)	36.0 mm	214-7223	490.0 mm (19.29 in)
18.0 mm	6V-9098	267.0 mm (10.51 in)	46.0 mm	9U-5130 ⁽²⁾	596.0 mm (23.46 in)
19.0 mm	6V-9099	280.0 mm (11.02 in)	55.0 mm	454-3162 ⁽³⁾	711 mm (28 in)

1 Box end is 6 point

2 Black oxide finish

3 Satin finish, warranty: Manufacturer Six Months

Wrenches — Cat Standard Wrenches

Metric Combination Wrenches



Warranty: Lifetime

- 15° angle on open end and 15° offset on box end
- Flank drive wrenches use the flat areas of the bolt or nut to loosen or tighten, rather than the corners, not stripping the bolts or nuts
- All are polished chrome finish except 386-3332 and 386-3333

Size	Part Number	Length
17.0 mm	386-3324	256 mm (10.08 in)
19.0 mm	386-3325	280 mm (11.02 in)
22.0 mm	386-3326	318 mm (12.52 in)
24.0 mm	386-3327	337 mm (13.28 in)
27.0 mm	386-3328	375 mm (14.76 in)
30.0 mm	386-3329	414 mm (16.30 in)
32.0 mm	386-3330	433 mm (17.05 in)
36.0 mm	386-3331	490 mm (19.29 in)
41.0 mm	386-3332 ⁽⁴⁾	546 mm (21.50 in)
46.0 mm	386-3333 ⁽⁵⁾	596 mm (23.46 in)

4 Satin finish

5 Black oxide finish

Wrenches — Cat Ratcheting Wrenches

Fractional Ratcheting Wrench Set, 8 piece - 248-8810



Warranty: Lifetime

- Dual pawl ratcheting box end
- 15° offset box head
- Box ends are reversible
- Durable nickel chrome finish

Part Number	Description	Size	Length
248-8810	Fractional Ratcheting Wrench Set	—	—
248-8811	Ratcheting Wrench	5/16	135 mm (5 5/16 in)
248-8812	Ratcheting Wrench	3/8	160 mm (6 5/16 in)
248-8813	Ratcheting Wrench	7/16	170 mm (6 11/16 in)
248-8814	Ratcheting Wrench	1/2	180 mm (7 1/16 in)
248-8815	Ratcheting Wrench	9/16	190 mm (7 1/2 in)
248-8816	Ratcheting Wrench	5/8	210 mm (8 1/4 in)
248-8817	Ratcheting Wrench	11/16	230 mm (9 1/16 in)
248-8818	Ratcheting Wrench	3/4	250 mm (9 13/16 in)

Ratcheting Box Wrench



Warranty: Caterpillar Standard Warranty, Six Months

- Single head
- Chrome finish
- 15 1/2 inches (39 cm) long

Part Number	Description	Size
451-9943	Single Head Ratcheting Box Wrench	1 5/8 in

Fractional Straight Handle Wrench Set, 11 Piece - 8T-3120



Warranty: Caterpillar Standard Warranty, 6 Months

- Available in hex sizes from 3/8 inch to 1 inch
- Ratchets in 45° increments (1/8 of a turn)
- Forged steel jaws, heat treated high carbon steel handles, and stainless steel rivets with a black corrosion-resistant finish

Wrenches — Cat Ratcheting Wrenches

Fractional Straight Handle Wrench Set, 11 Piece - 8T-3120 (Cont'd.)

Part Number	Description	Hex Size	Torque Capacity
8T-3120	Straight Handle Wrench Set	—	—
8T-3122	Wrench	3/8	26 N·m (19.18 ft·lb)
8T-3123	Wrench	7/16	29 N·m (21.39 ft·lb)
8T-3124	Wrench	1/2	34 N·m (25.08 ft·lb)
8T-3125	Wrench	9/16	45 N·m (33.19 ft·lb)
8T-3126	Wrench	5/8	68 N·m (50.15 ft·lb)
8T-3127	Wrench	11/16	86 N·m (63.43 ft·lb)
8T-3128	Wrench	3/4	97 N·m (71.54 ft·lb)
8T-3129	Wrench	13/16	114 N·m (84.08 ft·lb)
8T-3130	Wrench	7/8	141 N·m (104 ft·lb)
8T-3131	Wrench	15/16	159 N·m (117.27 ft·lb)
8T-3132	Wrench	1	170 N·m (125.39 ft·lb)

Fractional Straight Handle Wrench Set, 6 Piece - 8T-3227



Warranty: Caterpillar Standard Warranty: 6 Months

- Available in hex sizes from 1 1/16 inch to 1 5/8 inch
- Ratchets in 45° increments (1/8 of a turn)
- Forged steel jaws, heat treated high carbon steel handles, and stainless steel rivets with a black corrosion-resistant finish

Part Number	Description	Hex Size	Torque Capacity
8T-3227	Straight Handle Wrench Set	—	—
8T-3133	Wrench	1 1/16 in	190 N·m (140.14 ft·lb)
8T-3134	Wrench	1 1/8 in	200 N·m (147.51 ft·lb)
8T-3135	Wrench	1 1/4 in	270 N·m (199.14 ft·lb)
8T-3136	Wrench	1 3/8 in	340 N·m (250.77 ft·lb)
8T-3137	Wrench	1 1/2 in	410 N·m (302.40 ft·lb)
8T-3138	Wrench	1 5/8 in	475 N·m (350.34 ft·lb)

Metric Ratcheting Wrench Set, 12 piece - 248-8819



Warranty: Lifetime

- Dual pawl ratcheting box end
- 15° offset box head
- Box ends are reversible
- Durable nickel chrome finish

Wrenches — Cat Ratcheting Wrenches

Metric Ratcheting Wrench Set, 12 piece - 248-8819 (Cont'd.)

Size	Part Number	Description	Length
—	248-8819	Ratcheting Wrench Set	—
8.0	248-8820	Ratcheting Wrench	135.0 mm (5.5 in)
9.0	248-8822	Ratcheting Wrench	150.0 mm (5.9 in)
10.0	248-8823	Ratcheting Wrench	160.0 mm (6.3 in)
11.0	248-8824	Ratcheting Wrench	170.0 mm (6.7 in)
12.0	248-8825	Ratcheting Wrench	175.0 mm (6.9 in)
13.0	248-8826	Ratcheting Wrench	180.0 mm (7.1 in)
14.0	248-8827	Ratcheting Wrench	190.0 mm (7.5 in)
15.0	248-8828	Ratcheting Wrench	200.0 mm (7.9 in)
16.0	248-8829	Ratcheting Wrench	210.0 mm (8.3 in)
17.0	248-8830	Ratcheting Wrench	230.0 mm (9.1 in)
18.0	248-8831	Ratcheting Wrench	240.0 mm (9.4 in)
19.0	248-8832	Ratcheting Wrench	250.0 mm (9.8 in)

Ratchet Wrench - 9U-6517



Model: 5000 Series Mining Excavators

SMCS Code: 7063-010, 7063-017, 0602

Warranty: Lifetime

- Used to quickly remove and install bolts (Use standard wrench for initial loosening; bolts cannot be tightened to final torque with ratchet wrench.)
- For 30 mm hex bolts
- Fits 46 mm (1 13/16 in) bolt heads
- Ratcheting style wrench greatly decreases time for removing or installing the many bolts required to attach swing bearing/gear (Starting and running bolts down until seated, or removing bolts, can take a large amount of time if done with conventional hand tools.)

Reference:

SENR6058, 5130 Service Manual Module, Disassembly and Assembly; SENR6108, 5230 Service Manual Module, Disassembly and Assembly; SEHS9721 Special Instruction, Assembly Procedure for Hydraulic Excavator (5130 only)

Part Number	Wrench Type	Bolt Head Size	Torque Specification	Thickness	Head Diameter	Overall Length
9U-6517	Ratcheting box end	46 mm (1.81 in)	up to 490 N•m (366 lb ft)	16.0 mm (0.63 in)	80.8 mm (3.18 in)	354.0 mm (14.00 in)

Wrenches — Cat Ratcheting Wrenches

Ratcheting Box Flare Wrench, 3/4 inch Square Drive



Warranty: See individual part number

- Not sold as part of any sets - must be ordered individually

Part Number	Description	Hex Size
1U-5734	Wrench Assembly ⁽¹⁾	2 in

¹ Warranty: Six Months

Wrenches — Angle Wrenches

Angle Wrench Set, 30° and 60° Offset, 14 Piece - 1P-3515

Warranty: Lifetime

- Offset wrenches allow the use of one wrench in four different positions to gain additional turning angles.



Part Number	Description	Size	Length
1P-3515	Angle Wrench Set	—	—
1P-3501	Angle Wrench	3/8 in	122.9 mm (4.84 in)
1P-3502	Angle Wrench	7/16 in	137.4 mm (5.41 in)
1P-3503	Angle Wrench	1/2 in	151.6 mm (5.97 in)
1P-3504	Angle Wrench	9/16 in	166.6 mm (6.56 in)
1P-3505	Angle Wrench	5/8 in	180.8 mm (7.12 in)
1P-3506	Angle Wrench	11/16 in	197.6 mm (7.78 in)
1P-3507	Angle Wrench	3/4 in	210.3 mm (8.28 in)
1P-3508	Angle Wrench	13/16 in	225.6 mm (8.88 in)
1P-3509	Angle Wrench	7/8 in	239.8 mm (9.44 in)
1P-3510	Angle Wrench	15/16 in	254 mm (10 in)
1P-3511	Angle Wrench	1 in	269 mm (10.59 in)
1P-3512	Angle Wrench	1/16 in	283.5 mm (11.16 in)
1P-3513	Angle Wrench	1/8 in	298.5 mm (11.75 in)
1P-3514	Angle Wrench	1/4 in	327.2 mm (12.88 in)
Additional Sizes			
127-2277	Angle Wrench	3/8 in	356.6 mm (14.04 in)
127-2278	Angle Wrench	1/2 in	385.8 mm (15.19 in)
127-2279	Angle Wrench	5/8 in	415 mm (16.34 in)
127-2280	Angle Wrench	7/8 in	473.2 mm (18.63 in)

Angle Wrench Set, 7 Piece - 233-1635

Warranty: Lifetime

- Continuous arc open end design evenly distributes applied stress over the entire radius of the open end, enhancing the wrench strength and life of the tool
- Long handles for better reach and greater applied torque
- Highly polished nickel/chrome plating—tough nickel for corrosion resistance and chrome plating for wear resistance and a mirror-like finish



Drive	Part Number	Description	Length
—	233-1635	Angle Wrench Set	—
3/8 in	1P-3501	Angle Wrench	122.9 mm (4.84 in)
7/16 in	1P-3502	Angle Wrench	137.4 mm (5.41 in)
1/2 in	1P-3503	Angle Wrench	151.6 mm (5.97 in)
9/16 in	1P-3504	Angle Wrench	166.6 mm (6.56 in)
5/8 in	1P-3505	Angle Wrench	180.8 mm (7.12 in)

Wrenches — Angle Wrenches

Angle Wrench Set, 7 Piece - 233-1635 (Cont'd.)

Drive	Part Number	Description	Length
11/16 in	1P-3506	Angle Wrench	197.6 mm (7.78 in)
3/4 in	1P-3507	Angle Wrench	210.3 mm (8.28 in)

Angle Wrench Set, Large, 7 Piece - 233-1636



Warranty: Lifetime

- Continuous arc open end design evenly distributes applied stress over the entire radius of the open end, enhancing the wrench strength and life of the tool
- Long handles for better reach and greater applied torque
- Highly polished nickel/chrome plating — tough nickel for corrosion resistance and chrome plating for wear resistance and a mirror-like finish

Drive	Part Number	Description	Length
—	233-1636	Angle Wrench Set, Large	—
13/16 in	1P-3508	Angle Wrench	225.6 mm (8.88 in)
7/8 in	1P-3509	Angle Wrench	239.8 mm (9.44 in)
15/16 in	1P-3510	Angle Wrench	254.0 mm (10 in)
1 in	1P-3511	Angle Wrench	269.0 mm (10.59 in)
1/16 in	1P-3512	Angle Wrench	283.5 mm (11.16 in)
1/8 in	1P-3513	Angle Wrench	298.5 mm (11.75 in)
1/4 in	1P-3514	Angle Wrench	327.2 mm (12.88 in)

Half-Moon Wrench - 194-4935



Warranty: Caterpillar Standard Warranty, Lifetime

- Moon-shaped wrench to help you get at hard to reach bolts
- Box end, 5/8 in and 3/4 in
- 12-point

Part Number	Description
194-4935	Half-Moon Wrench

Wrenches — Adjustable Wrenches

Heavy-Duty Adjustable End Wrench

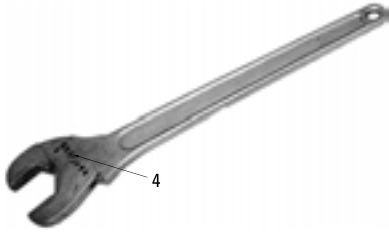

Warranty: Caterpillar Standard Warranty, 6 Months

- Designed for heavy-duty work
- Accommodate many of the larger nuts on Caterpillar and other equipment
- Cadmium coated to prevent rusting
- Jaw adjusts in 1/8 inch increments

Item	Part Number	Description	Jaw Range	Jaw Thickness	Length	Weight
–	8F-2243	Heavy Duty Wrench	69.9-120.7 mm (2 3/4 in-4 3/4 in)	28.6 mm (1 1/8 in)	914.4 mm (36 in)	10.0 kg (22 lb)
Service Parts for 8F-2243						
–	8F-2246	Bolt	–	–	–	–
4	5B-3254	Nut	–	–	–	–

Adjustable Wrenches



Warranty: See individual part number

Part Number	Jaw Range	Length	Finish
214-7322	24.0 mm (0.94 in) ⁽¹⁾	203.2 mm (8 in)	Black Oxide
214-7323	29.0 mm (1.13 in) ⁽²⁾	254.0 mm (10 in)	Black Oxide
214-7330	33.0 mm (1.31 in) ⁽¹⁾	304.8 mm (12 in)	Black Oxide
214-7332	42.0 mm (1.66 in) ⁽²⁾	381.0 mm (15 in)	Black Oxide

1 Warranty: Lifetime
2 Warranty: Six Months

Wrenches — Pipe Wrenches

Aluminum Pipe Wrenches



Warranty: Lifetime

- 10 inch through 24 inch
- 35% lighter than cast iron wrenches
- Heat treated titanium — aluminum alloy handle
- Forged hook jaw
- Heat-treated alloy steel parts interchangeable with iron wrenches

Item	Part Number	Description	Pipe Capacity	Length
1	4C-6974	Aluminum Wrench	14.0 mm - 63.0 mm (.25 in - 2.00 in)	356.0 mm (14.02 in)
2	4C-6975	Aluminum Wrench	14.0 mm - 75.0 mm (.25 in - 2.50 in)	457.0 mm (17.99 in)
3	4C-6976	Aluminum Wrench	14.0 mm - 90.0 mm (1.25 in - 3.00 in)	610.0 mm (24.02 in)
Not shown	4C-6973	Aluminum Wrench	10.0 mm - 48.0 mm (.13 in - 1.50 in)	254.0 mm (10 in)

Heavy-Duty Pipe Wrenches



Warranty: Lifetime

- High-tensile ductile iron handle and hardened tool-steel parts
- Designed to withstand heavy demands

Part Number	Pipe Capacity	Length	Weight
4C-6962	10.0 mm - 48.0 mm (.13 in - 1.50 in)	254.0 mm (10.00 in)	5.4 kg (12 lb)
4C-6963	10.0 mm - 60.0 mm (.13 in - 2.00 in)	305.0 mm (12.00 in)	8.1 kg (18 lb)
4C-6964	14.0 mm - 63.0 mm (.25 in - 2.00 in)	356.0 mm (14.00 in)	9.5 kg (21 lb)
4C-6965	14.0 mm - 75.0 mm (.25 in - 2.50 in)	457.0 mm (18.00 in)	15.0 kg (33 lb)
4C-6972	14.0 mm - 90.0 mm (.25 in - 3.00 in)	610.0 mm (24.00 in)	27.2 kg (60 lb)

48 Inch Pipe Wrench - 386-3304



Warranty: Manufacturer, Lifetime

- Professional Strength
- 98% Lightweight Aluminum, 2% Steel

Part Number	Max. Pipe Capacity	Length
386-3304	152.4 mm (6.00 in)	1219.0 mm (48.00 in)

Wrenches — Pipe Wrenches

48 inch Pipe Wrench



Warranty: Caterpillar Standard Warranty, Six Months

- Heavy-duty construction for strength and durability
- Forty percent lighter than cast iron
- Built-in pipe diameter scale

Part Number	Max Pipe Capacity	Length
457-3048	152.4 mm (6.00 in)	1219.0 mm (48.00 in)

60-Inch Pipe Wrench - 423-8977



Warranty: Manufacturer, Lifetime

- Professional Strength
- Cast Iron Handle
- Forged Steel Jaws
- Meets or exceeds: GGG-N65IE, Type II, Class A

Part Number	Max Pipe Capacity	Length
423-8977	20 cm (8 in)	152 cm (60 in)

Wrenches — Chain Wrenches

Chain Wrench for Special Applications - 1U-8760



Warranty: Caterpillar Standard Warranty, 6 Months

- Used for holding cylinders and other irregularly shaped objects—works for parts of most any size and shape
- Special head design for turning wrench in either direction
- Ratcheting action makes it possible to regrip without removal
- Chain wrench capacity: 1/2 inch to 4 3/4 inch O.D

Part Number	Description	Size
1U-8760	Wrench for Special Applications	Chain wrench capacity: 1/2 in to 4 3/4 in O.D.

Chain Wrench Group - 3P-1535



SMCS Code: 4303-017, 5105-017, 5309-017, 5102-017

Model: 16G, 518, 613C, 615, 910

Warranty: Caterpillar Standard Warranty, 6 Months

- Used to remove and install threaded crown, which is used to retain head on later hydraulic cylinders
- General purpose tool that can be used in many applications

Item	Part Number	Description
—	3P-1535	Chain Wrench Group
1	3P-1536	Handle
2	1U-8792	Chain Wrench Assembly, Handle Length 482.6 mm (19.00 in)
3	1U-8791	Chain - part of 1U-8792, 76.2 mm (3.00 in) O.D. Minimum and 171.5 mm (6.75 in) O. D. Maximum
4	3P-1537	Pin - part of 1U-8792

Wrenches — Filter Wrenches

Filter Strap Wrench - 185-3630

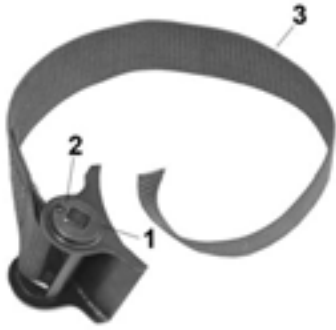

Warranty: Caterpillar Standard Warranty, 6 Months

- Provides quick, efficient service when removing or installing all spin-on type fuel and oil filters
- Capable of applying higher torques required on larger filters without denting filter can

Item	Part Number	Description
—	185-3630	Filter Strap Wrench Assembly
1	6H-7378	Retaining Ring
2	1P-0551	Spring Pin
3	2P-8253	Strap

Filter Wrench - 187-2718



Warranty: Lifetime

- Used to remove spin-on oil and fuel filters
- Makes filter removal quick and easy
- Fits filter diameters between 88.9 to 98.6 mm (3.50 to 3.88 in)

Part Number	Description
187-2718	Filter Wrench

Wrenches — Hex Wrenches

Fractional Hex Bit Set, 9 Piece - 9S-1742



Warranty: Lifetime

- Black oxide finish
- 3 1/2 inch cadmium case

Part Number	Description	Length	Size
9S-1742	Hex Key Wrench Assembly	3 in bits	9 bits: .05 in, 1/16 in, 5/64 in, 3/32 in, 7/64 in, 1/8 in, 9/64 in, 5/32 in, 3/16 in

Fractional "L" Shaped Hex Key Wrench Set, 13 Piece - 200-1928



Warranty: Lifetime

- Plastic holder included

Part Number	Description	Size
200-1928	Fractional Hex Key Set	.05 in, 1/16 in, 5/64 in, 3/32 in, 7/64 in, 1/8 in, 9/64 in, 5/32 in, 3/16 in, 7/32 in, 1/4 in, 5/16 in and 3/8 in

Fractional Hex Key Wrench Set with Ball End, 13 Piece - 293-3025



Warranty: Lifetime

- Cat branded plastic holder included

Part Number	Description	Size
293-3025	Fractional Ball-end Hex Wrench Set	.05 in, 1/16 in, 5/64 in, 3/32 in, 7/64 in, 1/8 in, 9/64 in, 5/32 in, 3/16 in, 7/32 in, 1/4 in, 5/16 in and 3/8 in

Wrenches — Hex Wrenches

Metric Hex Bit Set, 7 Piece - 200-1931



Warranty: Lifetime

- Black oxide finish bits
- Chrome plated case

Part Number	Description	Length	Size
200-1931	Metric Hex Key Set	76.2 mm (3.00 in) long bits	1.5 mm, 2.0 mm, 2.5 mm, 3.0 mm, 4.0 mm, 5.0 mm, 6.0 mm

Metric "L" Shaped Hex Key Wrench Set, 9 Piece - 200-1929



Warranty: Lifetime

- Cat branded plastic holder included

Part Number	Description	Size
200-1929	Metric Hex Key Set	1.5 mm, 2.0 mm, 2.5 mm, 3.0 mm, 4.0 mm, 5.0 mm, 6.0 mm, 8.0 mm, and 10.0 mm

Metric Hex Key Wrench Set with Ball End, 9 Piece - 293-3026



Warranty: Lifetime

- Cat branded plastic holder included

Part Number	Description	Size
293-3026	Metric Ball-end Hex Wrench Set	1.5 mm, 2.0 mm, 2.5 mm, 3.0 mm, 4.0 mm, 5.0 mm, 6.0 mm, 8.0 mm, and 10.0 mm

"L" Shaped Torx Wrench T50 - 256-4879



Warranty: Lifetime

Part Number	Description	Length	Flute Length	Material
256-4879	Torx Wrench, T50	95.25 mm (3.75 in)	8.84 mm (0.348 in)	steel

Wrenches — Hex Wrenches

Hex Key Wrenches, Standard and Metric



Warranty: Lifetime unless otherwise noted

- Extra length hex keys
- Inch and metric sizes

Part Number	Size
1U-7559	1.5 mm
1U-7560	2 mm
1U-7561	2.5 mm
1U-7562	3 mm
1U-7563	4 mm
1U-7564	5 mm
1U-7565	6 mm
1U-7566	8 mm
1U-7567	10 mm
1U-7568	12 mm
1U-7569	14 mm

Part Number	Size
1U-7570	17 mm
1U-7571	19 mm
1U-7572	1/16 in
1U-7573	5/64 in
1U-7574	3/32 in
1U-7575	1/8 in
1U-7576	5/32 in
1U-7577	3/16 in
1U-7578	7/32 in
1U-7579	1/4 in

Part Number	Size
1U-7580	5/16 in
1U-7581	3/8 in
1U-7582	7/16 in
1U-7583	1/2 in
1U-7584	9/16 in
1U-7585	5/8 in
1U-7586	1 in
1U-7632	3/4 in
4C-4067	22 mm

T-Handle Allen Head Wrench Set

Warranty: Caterpillar Standard Warranty: Six Months

- Cushion grip
- Rust preventive coating
- Protanium steel
- Welded handle

Part Number	Description	Sizes
386-3239	8-piece Metric T-Handle Allen Head Wrench Set	2, 2.5, 3, 4, 5, 6, 8, 10
386-3240	10-piece Fractional T-Handle Allen Head Wrench Set	3/32, 7/64, 1/8, 9/64, 5/32, 3/16, 7/32, 1/4, 5/16, 3/8

Hollow Head Screw Hex Wrenches

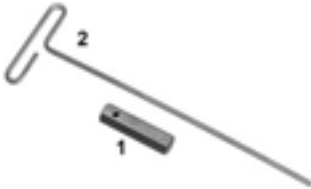

Warranty: Lifetime unless noted

- Used to remove and install hollow head screws

Item	Part Number	Description	Size
1	1P-3566	Bit, 14.28 mm (9/16 in)	9/16 in
1	9U-7419	Bit, 19.05 mm (3/4 in)	3/4 in
2	5P-4205	Wrench	5/32 in
2	6V-0115	Wrench ⁽¹⁾	1/8 in
2	6V-2104	Wrench ⁽¹⁾	3/32 in

1 Warranty: Six Months

Wrenches — Special Application Wrenches

Spark Plug Wrench - 2P-5481



1P-5559 Spark Plug Adapter Wrench

SMCS Code: 1555-011

Model: 5.4 inch Bore Natural Gas Engines

Warranty: Lifetime

- Used to remove spark plugs and adapters on 5.4 inch Bore Natural Gas Engines (G342, G353, G379, G398)
- Especially useful because plugs and adapters are deeply recessed in top of engine
- 1P-5559 Wrench: Large end, 1.25 in; Small end, .75 in

Part Number	Description
1P-5559	Spark Plug Adapter Wrench
2P-5481	Spark Plug Wrench

Open End Wrenches



Warranty: Lifetime

- Tappet wrench
- For low torque applications

Size	Part Number	Length
1/2 in x 9/16 in	8H-8501	9.50 in

Wrench, 41.0 mm - 214-7329



SMCS Code: 4303-010

Model: Telescoping Material Handlers RT50, RT60, and RTC60, 214B Hydraulic Excavator

Warranty: Lifetime

- As special application tools, used to remove and install front steering cylinder linkage knuckle on Cat vehicles listed above
- Forged steel, straight-handled, open end, with black oxide finish

Part Number	Description	Size
214-7329	Open End Wrench	41.0 mm

Wrenches — Special Application Wrenches

Wrench, 55.0 mm - 4C-4065



SMCS Code: 4303-010

Models: Telescoping Material Handlers RT50, RT60, and RTC60

Warranty: Caterpillar Standard Warranty, 6 Months

- As special application tools, used to remove and install front steering cylinder linkage knuckle on Cat vehicles listed above
- Forged steel, straight-handled, open end, with black oxide finish

Part Number	Description	Size
4C-4065	Open End Wrench	55.0 mm

Special Open End Wrenches



Warranty: See individual part number

- Special application wrenches for tight and confined spaces

Part Number	Size	Offset
386-3368	24 mm ⁽¹⁾	30°
9B-1496	1 5/8 in ⁽²⁾	30°
0V-0455	1 7/8 in ⁽²⁾	30°
9F-3869	2 3/4 in ⁽¹⁾	20°
8F-2239	2 9/32 in ⁽³⁾	15°

Wrench Set, Double End Flare Nut, 3 Piece - 214-7335



Warranty: Lifetime

Part Number	Size	Description	Length
214-7335	–	Wrench Set	–
214-7315	1/2 in x 9/16 in	Wrench	173.0 mm (6.81 in)
214-7314	3/8 in x 7/16 in	Wrench	147.6 mm (5.81 in)
214-7317	5/8 in x 11/16 in	Wrench	200.8 mm (7.91 in)

¹ Warranty: Six Months

² Warranty: Lifetime

³ Warranty: Manufacturer, 30 Day

Wrenches — Special Application Wrenches

Individual Offset Wrenches, Double End Flare Nut



Warranty: Lifetime

Size	Part Number	Length
13/32 in and 15/32 in	5P-7254	127 mm (5 in)
17/32 in and 19/32 in	5P-7255	165.1 mm (6.50 in)
25/32 in and 29/32 in	5P-7256	190.5 mm (7.50 in)
3/4 in and 1 in	9S-1743	203.2 mm (8 in)

Special Application Wrenches

Warranty: Lifetime

Part Number	Description	Size	Offset	Application
128-8824	Deep Offset Wrench	16 mm	18 mm	Fuel system
128-8825	Deep Offset Wrench (17 and 19 mm)	17 mm	19 mm	Fuel system
5P-0144	Fuel Line Socket	—	—	Fuel line
5P-0167	—	—	—	Brake spring
5P-5195	—	—	—	Fuel line
8T-0833	Box, end, chrome, for use with 1/2 inch ratchet	9/16 inch	—	Fuel pump
9S-9149	Box, offset, chrome	7/16 inch	—	Brake shoe bolt adjustment

Saw Adjustment Wrench - 197-3672



Model: Harvester Head

Warranty: Caterpillar Standard Warranty, 6 Months

- Used to adjust saw tension on newer model saw heads
- Designed for easy access of adjustment nut
- Wrench opening: 3 3/4 inch

Part Number	Description	Size
197-3672	Saw Adjustment Wrench	Wrench opening: 3 3/4 in

Wrenches — Special Application Wrenches

Heavy-Duty Box Wrenches



Warranty: Lifetime

- Used to tighten large fasteners such as hitch pins

Item	Part Number	Description	Size
1	5P-7320	Wrench	38.1 mm (1.50 in)
2	9U-7376	Sledge Wrench	46.0 mm (1.81 in)
3	8T-3196	Offset Box Wrench	47.6 mm (1.88 in)
4	5P-1661	Sledge Wrench	114 mm (4.5 in)

Nut Spanner Wrenches

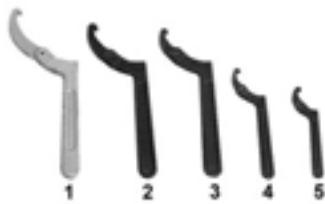

Warranty: Caterpillar Standard Warranty, 6 Months

Item	Part Number	Description	Diameter Range
1	1P-2856	Spanner Wrench	155.6-222.3 mm (6.13-8.75 in)
2	1P-2854	Spanner Wrench	114.3-158.8 mm (4.50-6.25 in)
3	1P-2853	Spanner Wrench ⁽⁴⁾	50.8-120.7 mm (2.00-4.75 in)
4	1P-2852	Spanner Wrench	31.8-76.2 mm (1.25-3.00 in)
5	1P-2851	Spanner Wrench	19.1-50.8 mm (.75-2.00 in)

Slug Wrenches



Warranty: Lifetime

- Designed to be struck by a hammer on end to loosen frozen fasteners or to set and tighten fasteners
- Heat treated for maximum durability and long life

Part Number	Size (inches)	Length
386-3286	1 1/2	194 mm (7.63 in)
386-3287	1 1/4	192 mm (7.55 in)
386-3288	1 11/16	198 mm (7.79 in)
386-3289	1 13/16	203 mm (7.99 in)
386-3290	1 3/4	203 mm (7.99 in)
386-3291	1 5/8	199 mm (7.83 in)
386-3292	1 7/16	194 mm (7.63 in)
386-3293	1 7/8	203 mm (7.99 in)

Part Number	Size (inches)	Length
386-3294	2 1/4	298 mm (11.73 in)
386-3295	2 3/16	298 mm (11.73 in)
386-3296	2 3/8	302 mm (11.88 in)
386-3297	2	294 mm (11.57 in)
386-3298	3 1/2	456 mm (17.95 in)
386-3299	3 7/8	456 mm (17.95 in)
386-3300	1 3/16	192 mm (7.55 in)
386-3301	4	457 mm (17.99 in)

⁴ Warranty: Lifetime

Wrenches — Crowfoot Wrenches

Fractional Open-End Crowfoot Wrench Group, 9 piece, 3/8 inch Drive - 2P-5520

Warranty: Lifetime

- Can be used with 3/8 inch drive ratchet or torque wrenches
- Can be ordered by set or individually



Part Number	Description	Size	Drive
2P-5520	Open-End Crowfoot Wrench Group		
2P-5487	Adapter	3/8	3/8
2P-5488	Wrench	7/16	3/8
2P-5489	Wrench	1/2	3/8
2P-5491	Wrench	9/16	3/8
2P-5492	Wrench	5/8	3/8
2P-5493	Wrench	11/16	3/8
2P-5494	Wrench	3/4	3/8
2P-5495	Wrench	13/16	3/8
2P-5496	Wrench	7/8	3/8

Fractional Crowfoot Wrench Group, 11 Piece - 5P-0336

Warranty: Lifetime

- 12 point
- May be used with 3/8 inch or 1/2 inch drive ratchet or torque wrenches
- Can be ordered by set or individually



Part Number	Description	Size	Drive
5P-0336	Crowfoot Wrench Group	—	—
5P-0324	Wrench	5/8 in	3/8 in
5P-0325	Wrench	11/16 in	3/8 in
5P-0326	Crowfoot Wrench	3/4 in	3/8 in
5P-0327	Wrench	13/16 in	3/8 in
5P-0328	Crowfoot Wrench (Fuel Line)	7/8 in	3/8 in
5P-0329	Crowfoot Wrench (Fuel Line)	15/16 in	3/8 in
5P-0331	Wrench	1 in	3/8 in
5P-0332	Wrench	1 1/16	3/8 in
5P-0333	Crowfoot Wrench	1 1/8 in	1/2 in
5P-0334	Wrench	1 1/4 in	1/2 in
5P-0335	Wrench	1 3/8 in	1/2 in
Optional Wrenches (not included in 5P-0336)			
463-1899	Crowfeet Wrench (Fuel Line)	11/16 in	3/8 in
1U-5536	Crowfoot Wrench	1 5/16 in	1/2 in
1U-5732	Wrench	1 3/4 in	3/8 in

Wrenches — Crowfoot Wrenches

Fractional Crowfoot Wrench Group, 11 Piece - 5P-0336 (Cont'd.)

Part Number	Description	Size	Drive
1U-5734	Wrench	2 in	3/8 in
1U-5735	Wrench	2 1/8 in	3/8 in
5P-0294	Wrench	1 11/16 in	1/2 in

15-Piece 1/2-inch Fractional Crowfoot Wrench Set

Warranty: Caterpillar Lifetime Warranty

Special alloy steel for strength and durability

Continuous arc open end minimizes jaw spread for constant contact with the fastener to give you the maximum torque with the minimum torque transmission loss

Available as a set or individually

Part Number	Description	Size	Drive
430-9053	15- Piece Fractional Crowfoot Wrench Set	—	1/2 in
Individual Drivers			
430-9038	Crowfoot Wrench	1 1/16 in	1/2 in
430-9039	Crowfoot Wrench	1 1/8 in	1/2 in
430-9040	Crowfoot Wrench	1 3/16 in	1/2 in
430-9041	Crowfoot Wrench	1 1/4 in	1/2 in
430-9042	Crowfoot Wrench	1 5/16 in	1/2 in
430-9043	Crowfoot Wrench	1 3/8 in	1/2 in
430-9044	Crowfoot Wrench	1 7/16 in	1/2 in
430-9045	Crowfoot Wrench	1 1/2 in	1/2 in
430-9046	Crowfoot Wrench	1 9/16 in	1/2 in
430-9047	Crowfoot Wrench	1 5/8 in	1/2 in
430-9048	Crowfoot Wrench	1 11/16 in	1/2 in
430-9049	Crowfoot Wrench	1 3/4 in	1/2 in
430-9050	Crowfoot Wrench	1 13/16 in	1/2 in
430-9051	Crowfoot Wrench	1 7/8 in	1/2 in
430-9052	Crowfoot Wrench	2 in	1/2 in

Metric Flare Nut Crowfoot Wrench Set - 305-3129



Warranty: Caterpillar Lifetime Warranty

- 6 point
- 3/8 inch drive

Part Number	Description	Size	Drive
305-3129	Metric Flare Nut Crowfoot Wrench Set	9 - 22 mm	3/8
Crowfoot Wrench Set Consists of:			

Wrenches — Crowfoot Wrenches

Metric Flare Nut Crowfoot Wrench Set - 305-3129 (Cont'd.)

Part Number	Description	Size	Drive
305-3115	Flare Nut Crowfoot Wrench	9 mm	3/8
305-3116	Flare Nut Crowfoot Wrench	10 mm	3/8
305-3117	Flare Nut Crowfoot Wrench	11 mm	3/8
305-3118	Flare Nut Crowfoot Wrench	12 mm	3/8
305-3119	Flare Nut Crowfoot Wrench	13 mm	3/8
305-3120	Flare Nut Crowfoot Wrench	14 mm	3/8
305-3121	Flare Nut Crowfoot Wrench	15 mm	3/8
305-3122	Flare Nut Crowfoot Wrench	16 mm	3/8
305-3123	Flare Nut Crowfoot Wrench	17 mm	3/8
305-3124	Flare Nut Crowfoot Wrench	18 mm	3/8
305-3125	Flare Nut Crowfoot Wrench	19 mm	3/8
305-3126	Flare Nut Crowfoot Wrench	20 mm	3/8
305-3127	Flare Nut Crowfoot Wrench	21 mm	3/8
305-3128	Flare Nut Crowfoot Wrench	22 mm	3/8
Additional Crowfoot Wrenches			
386-3367	Flare Nut Crowfoot Wrench	24 mm	3/8

Ratchets and Sockets — Ratchet and Socket Sets

Fractional Socket Set, 17 Piece, 1/4 inch Drive - 213-4443



Warranty: See individual part number

- 12 point
- 1/4 inch square drive
- Standard length sockets
- Chrome finish

Size	Length	Part Number	Description
–	–	213-4443	Socket Set ⁽¹⁾
Socket Set Consists of:			
1/2 in	22.2 mm (.88 in)	9S-1719	Socket
1/4 in	22.2 mm (.88 in)	9S-1713	Socket
11/32 in	22.2 mm (.88 in)	9S-1716	Socket
3/16 in	22.2 mm (.88 in)	9S-1711	Socket
3/8 in	22.2 mm (.88 in)	9S-1717	Socket
5/16 in	22.2 mm (.88 in)	9S-1715	Socket
7/16 in	22.2 mm (.88 in)	9S-1718	Socket
7/32 in	22.2 mm (.88 in)	9S-1712	Socket
9/32 in	22.2 mm (.88 in)	9S-1714	Socket
Accessories			
–	159.5 mm (6.28 in)	9S-1725	Case ⁽²⁾
1/4 in	–	239-6823	Reversible Ratchet
1/4 in	–	9S-1722	Socket Driver
1/4 in Female to 3/8 in male	–	213-4437	Socket Adapter
1/4 in	–	9S-1724	Universal Joint
101.6 mm (4.00 in)	–	9S-1721	Extension
3/8 in Female to 1/4 in male	–	261-0443	Socket Adapter
50.8 mm (2.00 in)	–	9S-1720	Socket Extension

Fractional Socket Set, 11 Piece, 3/8 inch Drive - 9S-1746



Warranty: Lifetime

- 12 point
- 3/8 inch square drive
- Chrome finish
- Can be ordered by set or individually

¹ Warranty: Lifetime

² Warranty: Manufacturer, 90 Day

Ratchets and Sockets — Ratchet and Socket Sets

Fractional Socket Set, 11 Piece, 3/8 inch Drive - 9S-1746 (Cont'd.)

Size	Length	Part Number	Description
—	—	9S-1746	Socket Set
Sockets Set consists of:			
1/2 in	23.8 mm (0.94 in)	8H-8568	Socket
11/16 in	27 mm (1.06 in)	9S-1728	Socket
3/4 in	27.8 mm (1.09 in)	8H-8571	Socket
3/8 in	23 mm (0.91 in)	8S-2274	Socket
5/8 in	26.2 mm (1.03 in)	8H-8570	Socket
7/16 in	23 mm (0.91 in)	8H-8567	Socket
9/16 in	24.6 mm (0.97 in)	8H-8569	Socket
Accessories included			
152.4 mm (6.00 in) long	152.4 mm (6 in)	8H-8575	Extension Assembly
3/8 in	447.5 mm (17.62 in)	8H-8573	Speeder Handle
3/8 in	187.5 mm (7.38 in)	239-6824	Reversible Ratchet, 3/8 in Drive
76.2 mm (3.00 in) long	76.2 mm (3 in)	8H-8574	Socket Extension

Fractional Socket Set, 16 Piece, 1/2 inch Drive - 9S-1748



Warranty: Lifetime

- 12 point
- 1/2 inch square drive
- Chrome finish
- Can be ordered by set or individually

Size	Length	Part Number	Description
—	—	9S-1748	Socket Set
Socket Set Consists of:			
1 1/16 in	41.3 mm (1.63 in)	9S-1729	Socket
1 1/4 in	47.6 mm (1.87 in)	9S-1731	Socket
1 1/8 in	44.5 mm (1.75 in)	9S-1730	Socket
1 in	38.1 mm (1.50 in)	8H-8556	Socket, 1 in
1/2 in	38.1 mm (1.50 in)	1S-0259	Socket
11/16 in	38.1 mm (1.50 in)	8H-8551	Socket
13/16 in	38.1 mm (1.50 in)	8H-8553	Socket
15/16 in	38.1 mm (1.50 in)	8H-8555	Socket
3/4 in	38.1 mm (1.50 in)	8H-8552	Socket
5/8 in	38.1 mm (1.50 in)	8H-8550	Socket
7/8 in	38.1 mm (1.50 in)	8H-8554	Socket
9/16 in	38.1 mm (1.50 in)	8H-8549	Socket
Accessories Included			
1/2 in	381.0 mm (15 in)	239-6826	Reversible Ratchet

Ratchets and Sockets — Ratchet and Socket Sets

Fractional Socket Set, 16 Piece, 1/2 inch Drive - 9S-1748 (Cont'd.)

Size	Length	Part Number	Description
1/2 in	457.2 mm (18 in)	168-0383	Breaker Bar
1/2 in drive, 127.0 mm (5.00 in) long	127.0 mm (5 in)	9S-1732	Extension – 127 mm (5.0 in) Long (1/2 in Drive)
1/2 in drive, 254.0 mm (10.00 in) long	279.0 mm (10.98 in)	8H-8559	Socket Extension

Fractional Socket Set, 21 Piece, 3/4 inch Drive - 9S-1749

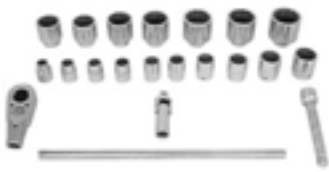

Warranty: Lifetime

- 12 point
- 3/4 inch drive
- Chrome finish
- Can be ordered by set or individually

Size	Length	Part Number	Description
–	–	9S-1749	Socket Set
Socket Set Consists of:			
1 1/16 in	54.0 mm (2.13 in)	8H-8533	Socket
1 1/2 in	63.5 mm (2.50 in)	8H-8537	Socket
1 1/4 in	57.2 mm (2.25 in)	8H-8535	Socket
1 1/8 in	55.5 mm (2.19 in)	8H-8534	Socket
1 11/16 in	69.9 mm (2.75 in)	8H-8538	Socket
1 3/4 in	69.9 mm (2.75 in)	8H-8540	Socket
1 5/16 in	58.7 mm (2.31 in)	8H-8536	Socket
1 5/8 in	66.7 mm (2.63 in)	8H-8539	Socket
1 7/8 in	79.4 mm (3.13 in)	8H-8541	Socket
1 in	52.4 mm (2.06 in)	8H-8532	Socket
15/16 in	50.8 mm (2 in)	8H-8531	Socket
2 1/4 in	82.6 mm (3.25 in)	8H-8504	Socket
2 1/8 in	82.6 mm (3.25 in)	8H-8543	Socket
2 3/16 in	82.6 mm (3.25 in)	8H-8544	Socket
2 in	79.4 mm (3.13 in)	8H-8542	Socket
3/4 in	50.8 mm (2 in)	8H-8529	Socket
7/8 in	50.8 mm (2 in)	8H-8530	Socket
Accessories Included			
–	489.0 mm (19.25 in)	162-8716	Ratchet Head Handle
203.2 mm (8.00 in) long	203.2 mm (8 in)	8H-8548	Socket Extension

Ratchets and Sockets — Ratchet and Socket Sets

Fractional Socket Set, 21 Piece, 3/4 inch Drive - 9S-1749 (Cont'd.)

Size	Length	Part Number	Description
3/4 in	—	160-6389	Reversible Ratchet Head
3/4 in	93.6 mm (3.69 in)	8H-8546	Breaker Bar Head

Fractional Heavy-Duty Socket Set, 17 Piece, 1 inch Drive - 5S-6093



Warranty: See individual part number

- 6 point
- 1 inch square drive
- Black oxide finish
- Can be ordered by set or individually

Size	Length	Part Number	Description
—	—	5S-6093	Socket Set ⁽³⁾
Heavy-Duty Socket Set Consists of:			
2 1/2 in ⁽⁴⁾	104.8 mm (4.13 in)	5S-6078	Socket
2 3/4 in ⁽⁴⁾	114.3 mm (4.50 in)	5S-6080	Socket
2 3/8 in Hex	98.4 mm (3.87 in)	5S-6077	Socket
2 5/8 in ⁽⁴⁾	57.2 mm (2.25 in)	5S-6079	Socket
3 1/2 in ⁽⁴⁾	133.4 mm (5.25 in)	5S-6084	Socket
3 1/4 in ⁽⁴⁾	127 mm (5 in)	5S-6083	Socket
3 1/8 in ⁽⁴⁾	127 mm (5 in)	5S-6082	Socket
3 3/4 in ⁽⁴⁾	136.5 mm (5.37 in)	5S-6086	Socket
3 5/8 in ⁽⁴⁾	133.4 mm (5.25 in)	5S-6085	Socket
3 in	123.8 mm (4.87 in)	5S-6081	Socket
4 in ⁽⁴⁾	127 mm (5 in)	5S-6087	Socket
Accessories Included			
—	—	161-3983	Ratchet Head ⁽⁵⁾
—	—	5S-6088	Sledge Socket Wrench
—	—	5S-6090	Sliding T Wrench Head
—	736.6 mm (29 in)	5S-6089	Wrench Handle
—	788.67 mm (31.05 in)	5S-6092	Tool Box ⁽⁶⁾
203.2 mm (8.00 in)	203.2 mm (8 in)	5S-6076	Socket Extension

3 Warranty: Lifetime

4 Chrome Finish

5 161-3985 Repair Kit (5S-6094 Repair Kit is available for former 5S-6091 Ratchet Head)

6 Warranty: Manufacturer, 90 Day

Ratchets and Sockets — Ratchet and Socket Sets

Metric Ratchet Set, 17 Piece, 1/4 inch Drive - 233-1642

Warranty: Lifetime



- Socket contacts the fastener on the flats rather than on the corners, preventing rounding of the fastener and allowing for more torque to be applied
- Concentric or uniform wall thickness eliminates weak spots while allowing for a thin wall design for greater accessibility
- Creates positive engagement with the drive tool for a tight/slop-free driving system. Detents are located on all four inner walls ensuring positive engagement with the drive tool in any orientation.
- Hex and drive ends of the socket are countersunk or funnel-shaped, making engagement with the fastener or drive tool quicker and easier
- Nickel chrome plating provides a durable, corrosion resistant coating and a brilliant tool finish

Size	Length	Part Number	Description
–	–	233-1642	Metric Ratchet Set
Metric Ratchet Set Consists of:			
1/4 in	–	9S-1724	Universal Joint
1/4 in	112.3 mm (4.42 in)	9U-6635	Ratchet
10.0 mm	22.2 mm (0.87 in)	200-8423	Socket (1/4 in Drive)
101.6 mm (4.00 in)	101.6 mm (4 in)	9S-1721	Extension
11.0 mm	22.2 mm (0.87 in)	200-8424	Socket (1/4 in Drive)
12.0 mm	22.2 mm (0.87 in)	200-8426	Socket (1/4 in Drive)
13.0 mm	22.2 mm (0.87 in)	200-8427	Socket (1/4 in Drive)
14.0 mm	22.2 mm (0.87 in)	200-8428	Socket (1/4 in Drive)
15.0 mm	23.0 mm (0.91 in)	200-8429	Socket (1/4 in Drive)
4.0 mm	22.2 mm (0.87 in)	200-8415	Socket (1/4 in Drive)
5.0 mm	22.2 mm (0.87 in)	200-8417	Socket (1/4 in Drive)
5.5 mm	22.2 mm (0.87 in)	200-8418	Socket (1/4 in Drive)
50.8 mm (2.00 in)	50.8 mm (2 in)	9S-1720	Socket Extension
6.0 mm	22.2 mm (0.87 in)	200-8419	Socket (1/4 in Drive)
7.0 mm	22.2 mm (0.87 in)	200-8420	Socket (1/4 in Drive)
8.0 mm	22.2 mm (0.87 in)	200-8421	Socket (1/4 in Drive)
9.0 mm	22.2 mm (0.87 in)	200-8422	Socket (1/4 in Drive)

Ratchets and Sockets — Ratchets and Repair Kits

Ratchet Set, 3 Piece - 233-1637



Warranty: Lifetime

- Sealed heads protect internal components from outside environment which leads to longer product life and reduced maintenance, and prevents gear slippage
- Heads forged to exact tolerances for longer tool life and greater head strength
- High strength internal mechanism provides longer tool life
- Ergonomic handle reduces user fatigue and has a more comfortable grip
- Reverse lever can be shifted with one hand which saves time when the gear mechanism needs to be reversed in tight places
- Square drive is close to the end of the head, giving maximum accessibility to fasteners in restricted areas
- Nickel chrome plating provides a durable, corrosion resistant coating and a brilliant tool finish

Part Number	Description	Drive	Length	Smallest Working Arc	Repair Kit
233-1637	Ratchet Set	—	—	—	—
Ratchet Set Consists of:					
239-6823	Reversible Ratchet	1/4 in	112.3 mm (4.42 in)	12.0 Degrees	230-0812
239-6824	Reversible Ratchet, 3/8 in Drive	3/8 in	187.5 mm (7.38 in)	12.0 Degrees	230-0813
239-6825	Ratchet (1/2 in Drive)	1/2 in	261.9 mm (10.31 in)	10.0 Degrees	214-7339

Ratchets



Warranty: Lifetime except ratchet 214-7340

- Sealed heads protect internal components from outside environment which leads to longer product life and reduced maintenance, and prevents gear slippage
- Heads forged to exact tolerances for longer tool life and greater head strength
- High strength internal mechanism provides longer tool life
- Ergonomic handle reduces user fatigue and has a more comfortable grip
- Reverse lever can be shifted with one hand which saves time when the gear mechanism needs to be reversed in tight places
- Square drive is close to the end of the head, giving maximum accessibility to fasteners in restricted areas
- Nickel chrome plating provides a durable, corrosion resistant coating and a brilliant tool finish

Ratchets and Sockets — Ratchets and Repair Kits

Ratchets (Cont'd.)

Part Number	Description	Size	Length	Smallest Working Arc	Repair Kit
194-4944 ⁽¹⁾	Ratchet	3/8	260.4 mm (10.25 in)	5.0 Degrees	—
214-7340 ⁽²⁾	Ratchet ⁽³⁾	1/2	287.3 mm (11.31 in)	4.5 Degrees	214-7341
239-6823	Reversible Ratchet	1/4	112.3 mm (4.42 in)	12.0 Degrees	230-0812
239-6824	Reversible Ratchet, 3/8 in Drive	3/8	187.5 mm (7.38 in)	12.0 Degrees	230-0813
239-6825	Ratchet (1/2 in Drive)	1/2	261.9 mm (10.31 in)	10.0 Degrees	214-7339
239-6826	Reversible Ratchet	1/2	381.0 mm (15 in)	10.0 Degrees	214-7339
263-3341 ⁽⁴⁾	Ratchet	1/2	448.6 mm (17.66 in)	10.0 Degrees	214-7339
Repair Kits for Discontinued Ratchets					
214-7333	Flex Head Ratchet	—	—	—	214-7339
5P-7443	Ratchet	—	—	—	5P-7444 (20 tooth gear) 5P-7445 (30 tooth gear)
8H-8557	Ratchet	—	—	—	4S-7326
9U-6635	Ratchet	—	112.3 mm (4.42 in)	—	9U-6636 (30 tooth gear)
9U-6637	Ratchet	—	—	—	9U-6638 (30 tooth gear)
9U-6639	Ratchet	—	—	—	9U-6640 (32 tooth gear)

Ratchet Heads

Warranty: Lifetime



Part Number ⁽⁵⁾	Size	Head Width	Head Length	Head Depth	Smallest Working Arc	Repair Kit
160-6389	3/4 in	63.0 mm (2.48 in)	150.9 mm (5.94 in)	31.2 mm (1.23 in)	11.2 Degrees	160-6390
161-3983	1 in	79.4 mm (3.12 in)	200.0 mm (7.86 in)	38.1 mm (1.50 in)	12.0 Degrees	161-3985

1 Offset round swivel head

2 Round head

3 Warranty: Six Months

4 Long flex handle

5 Note: 5S-6081 Ratchet Repair Kit is available for discontinued 8H-8545 Ratchet Head; 5S-6094 Ratchet Repair Kit is available for discontinued 5S-6091 Ratchet Head.

Ratchets and Sockets — Ratchet Handles and Breaker Bars

Handles



Warranty: Lifetime

Part Number	Drive	Length
162-8716	3/4 in	489 mm (19.25 in)
5S-6089	1 in	736.6 mm (29 in)

Head Breaker Bar, 3/4 inch Drive - 8H-8546



Warranty: Lifetime

Part Number	Drive	Length	Width
8H-8546	3/4 in	93.6 mm (3.69 in)	42.1 mm (1.66 in)

Breaker Bars



Warranty: Lifetime

Part Number	Drive	Length	Repair Kit
168-0383	1/2 in	457.2 mm (18 in)	293-0712
214-7316	1/4 in	152.4 mm (6 in)	—
214-7326	3/8 in	242.9 mm (9.56 in)	—
450-9220	3/4 in	914 mm (35.98 in)	—
386-3264	1 in	868 mm (34.17 in)	—
386-3254	1 1/2 in	914 mm (35.98 in)	—

Sliding T-Handle



Warranty: Lifetime

Part Number	Drive	Part Number	Length
213-1985	1/2 in		304.8 mm (12 in)
214-7319	1/4 in		114.3 mm (4.50 in)
386-3359	3/4 in		450 mm (19.25 in)

Ratchets and Sockets — Ratchet Handles and Breaker Bars

Sliding "T" Wrench Head - 5S-6090



Warranty: Lifetime

Part Number	Drive	Description	Use
5S-6090	1 in	Sliding T Wrench Head	5S-6089 Handle

Speeder Handle, 3/8 inch Drive - 8H-8573



Warranty: Lifetime

Part Number	Drive	Length
8H-8573	3/8 in	447.5 mm (17.62 in)

Hand Impact Wrench - 5P-2410



Warranty: Caterpillar Standard Warranty, 6 Months

- Loosen nuts bound by corrosion and tighten nuts to an estimated torque value readily with this impact wrench
- Particularly suited to field use because an air or electric power source is not required
- With a 1 inch square drive and capacity up to 2000 ft-lb torque, the wrench will handle 3/4 inch to 1 3/4 inch bolts
- Wrench action provides impact torque in one direction and free ratcheting in the other
- When turned about 30°, energy stored in a heavy spring in the handle is suddenly released, delivering a torsional impact to the square output drive through a link and rotary hammer arrangement. To reverse the direction of this action, the wrench is merely turned over. The amount of impact is adjustable.

Part Number	Description
5P-2410	Hand Impact Wrench
Hand Impact Replacement Parts	
1A-2209	Bolt
1H-8134	Ring

Ratchets and Sockets — Cat Sockets - 3/8 inch Drive

Fractional Socket Set, 7 Piece, 3/8 inch Drive - 214-1143



Warranty: Lifetime

- 6 point
- 3/8 inch square drive
- Standard length sockets
- Chrome finish
- Includes socket bar and clips
- Can be ordered by set or individually

Size	Length	Part Number	Description
–	–	214-1143	Socket Set
Socket Set Consists of:			
3/8 in	23.1 mm (0.91 in)	214-1144	Socket
7/16 in	23.1 mm (0.91 in)	214-1145	Socket
1/2 in	23.9 mm (0.94 in)	214-1146	Socket

Size	Length	Part Number	Description
9/16 in	26.2 mm (1.03 in)	214-1147	Socket
5/8 in	27.7 mm (1.09 in)	214-1148	Socket
11/16 in	28.7 mm (1.13 in)	214-1149	Socket
3/4 in	30.2 mm (1.19 in)	214-1150	Socket

Fractional Socket Set, 9 Piece, 3/8 inch Drive - 214-1151



Warranty: See individual part number

- 6 point
- 3/8 inch square drive
- Deep length sockets
- Polished chrome finish
- Includes socket bar and clips
- Can be ordered by set or individually

Size	Length	Part Number	Description
–	–	214-1151	Socket Set
Socket Set Consists of:			
3/8 in	54.0 mm (2.13 in)	214-1152	Socket
7/16 in	54.0 mm (2.13 in)	214-1153	Socket
1/2 in	60.3 mm (2.37 in)	214-1154	Socket
9/16 in	60.3 mm (2.37 in)	214-1155	Socket

Size	Length	Part Number	Description
5/8 in	60.3 mm (2.37 in)	214-1156	Socket
11/16 in	66.7 mm (2.63 in)	214-1157	Socket
3/4 in	66.7 mm (2.63 in)	214-1158	Socket
13/16 in	69.9 mm (2.75 in)	214-1159	Socket
7/8 in	69.9 mm (2.75 in)	214-1160	Socket

Ratchets and Sockets — Cat Sockets - 3/8 inch Drive

Fractional Socket Set, 9 Piece, 3/8 inch Drive - 214-6490



Warranty: Lifetime

- 12 point
- 3/8 inch square drive
- Deep length sockets
- Chrome finish
- Includes socket bar and clips
- Can be ordered by set or individually

Size	Length	Part Number	Description
–	–	214-6490	Socket Set
3/8 in	54.1 mm (2.13 in)	214-6491	Socket
7/16 in	54.1 mm (2.13 in)	214-6492	Socket
1/2 in	60.5 mm (2.38 in)	214-6493	Socket
9/16 in	60.5 mm (2.38 in)	8S-2357	Deep Well Socket

Size	Length	Part Number	Description
5/8 in	60.5 mm (2.38 in)	9S-5031 ⁽¹⁾	Deep Well Socket
11/16 in	66.8 mm (2.63 in)	214-6494	Socket
3/4 in	66.8 mm (2.63 in)	214-6495	Socket
13/16 in	69.9 mm (2.75 in)	214-6496	Socket
7/8 in	69.9 mm (2.75 in)	6V-0199	Socket

Metric Socket Set, 12 Piece, 3/8 inch Drive - 194-3574



Warranty: Lifetime

- 12 point
- 3/8 inch drive
- Standard length sockets
- Polished chrome finish
- Includes socket bar and clips
- Can be ordered by set or individually

Size	Length	Part Number	Description
–	–	194-3574	3/8 Drive, 12 Point Metric Socket Set, 12-piece
Socket Set Consists of:			
8.0 mm	23.0 mm (0.91 in)	194-3480	Socket (3/8 in Drive)
9.0 mm	23.0 mm (0.91 in)	194-3483	Socket (3/8 in Drive)
10.0 mm	23.0 mm (0.91 in)	194-3488	Socket (3/8 in Drive)
11.0 mm	23.0 mm (0.91 in)	194-3490	Socket (3/8 in Drive)
12.0 mm	23.8 mm (0.94 in)	194-3492	Socket (3/8 in Drive)

Size	Length	Part Number	Description
13.0 mm	24.6 mm (0.97 in)	194-3494	Socket (3/8 in Drive)
14.0 mm	26.2 mm (1.03 in)	194-3495	Socket (3/8 in Drive)
15.0 mm	27.0 mm (1.06 in)	194-3496	Socket (3/8 in Drive)
16.0 mm	27.8 mm (1.09 in)	194-3497	Socket (3/8 in Drive)
17.0 mm	28.6 mm (1.13 in)	194-3498	Socket (3/8 in Drive)
18.0 mm	28.6 mm (1.13 in)	194-3499	Socket (3/8 in Drive)
19.0 mm	30.2 mm (1.19 in)	194-3500	Socket (3/8 in Drive)

¹ Comes with insert for removing spark plugs

Ratchets and Sockets — Cat Sockets - 3/8 inch Drive

Metric Socket Set, 12 Piece, 3/8 inch Drive - 199-9019



Warranty: Lifetime

- 12 point
- 3/8 inch drive
- Deep length sockets
- Polished chrome finish
- Includes socket bar and clips
- Can be ordered by set or individually

Size	Length	Part Number	Description
–	–	199-9019	Metric Socket Set
Socket Set Consists of:			
8.0 mm	54.0 mm (2.13 in)	199-9023	Socket (3/8 in Drive)
9.0 mm	54.0 mm (2.13 in)	199-9025	Socket (3/8 in Drive)
10.0 mm	54.0 mm (2.13 in)	199-9026	Socket (3/8 in Drive)
11.0 mm	54.0 mm (2.13 in)	199-9027	Socket (3/8 in Drive)
12.0 mm	54.0 mm (2.13 in)	199-9028	Socket (3/8 in Drive)

Size	Length	Part Number	Description
13.0 mm	54.0 mm (2.13 in)	199-9029	Socket (3/8 in Drive)
14.0 mm	60.3 mm (2.37 in)	199-9030	Socket (3/8 in Drive)
15.0 mm	60.3 mm (2.37 in)	199-9031	Socket (3/8 in Drive)
16.0 mm	60.3 mm (2.37 in)	199-9032	Socket (3/8 in Drive)
17.0 mm	66.7 mm (2.63 in)	199-9033	Socket (3/8 in Drive)
18.0 mm	66.7 mm (2.63 in)	199-9034	Socket (3/8 in Drive)
19.0 mm	66.7 mm (2.63 in)	199-9035	Socket (3/8 in Drive)

Metric Socket Set, 12 Piece, 3/8 inch Drive - 214-6620



Warranty: Lifetime

- 6 point
- 3/8 inch drive
- Standard length sockets
- Chrome finish
- Includes socket bar and clips
- Can be ordered by set or individually

Size	Length	Part Number	Description
–	–	214-6620	Metric Socket Set
Socket Set Consists of:			
8.0 mm	23.0 mm (0.91 in)	214-6621	Socket (3/8 in Drive)
9.0 mm	23.0 mm (0.91 in)	214-6623	Socket (3/8 in Drive)
10.0 mm	23.0 mm (0.91 in)	214-6624	Socket (3/8 in Drive)
11.0 mm	23.0 mm (0.91 in)	214-6625	Socket
12.0 mm	23.8 mm (0.94 in)	214-6626	Socket (3/8 in Drive)

Size	Length	Part Number	Description
13.0 mm	24.6 mm (0.97 in)	214-6627	Socket (3/8 in Drive)
14.0 mm	26.2 mm (1.03 in)	214-6628	Socket (3/8 in Drive)
15.0 mm	27.0 mm (1.06 in)	214-6629	Socket (3/8 in Drive)
16.0 mm	27.8 mm (1.09 in)	214-6630	Socket (3/8 in Drive)
17.0 mm	28.6 mm (1.13 in)	214-6631	Socket (3/8 in Drive)
18.0 mm	28.6 mm (1.13 in)	214-6632	Socket (3/8 in Drive)
19.0 mm	30.2 mm (1.19 in)	214-6633	Socket (3/8 in Drive)

Ratchets and Sockets — Cat Sockets - 3/8 inch Drive

Metric Socket Set, 8 Piece, 3/8 inch Drive - 214-6634



Warranty: Lifetime

- 6 point
- 3/8 inch drive
- Deep length sockets
- Polished chrome finish
- Includes socket bar and clips
- Can be ordered by set or individually

Size	Length	Part Number	Description
–	–	214-6634	Metric Socket Set
Socket Set Consists of:			
10.0 mm	54.0 mm (2.13 in)	214-6635	Socket (3/8 in Drive)
11.0 mm	54.0 mm (2.13 in)	214-6636	Socket (3/8 in Drive)
12.0 mm	54.0 mm (2.13 in)	214-6637	Socket (3/8 in Drive)

Size	Length	Part Number	Description
13.0 mm	54.0 mm (2.13 in)	214-6638	Socket (3/8 in Drive)
14.0 mm	60.3 mm (2.37 in)	214-6639	Socket (3/8 in Drive)
15.0 mm	60.3 mm (2.37 in)	214-6640	Socket (3/8 in Drive)
17.0 mm	66.7 mm (2.63 in)	214-6641	Socket (3/8 in Drive)
19.0 mm	66.7 mm (2.63 in)	214-6642	Socket (3/8 in Drive)

Ratchets and Sockets — Cat Sockets - 1/4 inch Drive

Fractional Socket Set, 10 Piece, 1/4 inch Drive - 213-9965



Warranty: Lifetime

- 6 point
- 1/4 inch square drive
- Deep length sockets
- Chrome finish
- Includes socket bar and clips
- Can be ordered by set or individually

Size	Length	Part Number	Description
–	–	213-9965	Socket Set
Socket Set Consists of:			
3/16 in	50.8 mm (2 in)	213-9967	Socket
7/32 in	50.8 mm (2 in)	213-9968	Socket
1/4 in	50.8 mm (2 in)	213-9969	Socket
9/32 in	50.8 mm (2 in)	213-9970	Socket

Size	Length	Part Number	Description
5/16 in	50.8 mm (2 in)	213-9971	Socket
11/32 in	50.8 mm (2 in)	213-9972	Socket
3/8 in	50.8 mm (2 in)	213-9974	Socket
7/16 in	50.8 mm (2 in)	213-9978	Socket
1/2 in	50.8 mm (2 in)	213-9980	Socket
9/16 in	50.8 mm (2 in)	213-9981	Socket

Metric Socket Set, 13 Piece, 1/4 inch Drive - 200-8413



Warranty: Lifetime

- 6 point
- 1/4 inch drive
- Standard length sockets
- Polished chrome finish
- Includes socket bar and clips

Size	Length	Part Number	Description
–	–	200-8413	Metric Socket Set
Socket Set Consists of:			
4.0 mm	22.2 mm (0.87 in)	200-8415	Socket (1/4 in Drive)
5.0 mm	22.2 mm (0.87 in)	200-8417	Socket (1/4 in Drive)
5.5 mm	22.2 mm (0.87 in)	200-8418	Socket (1/4 in Drive)
6.0 mm	22.2 mm (0.87 in)	200-8419	Socket (1/4 in Drive)
7.0 mm	22.2 mm (0.87 in)	200-8420	Socket (1/4 in Drive)
8.0 mm	22.2 mm (0.87 in)	200-8421	Socket (1/4 in Drive)

Size	Length	Part Number	Description
9.0 mm	22.2 mm (0.87 in)	200-8422	Socket (1/4 in Drive)
10.0 mm	22.2 mm (0.87 in)	200-8423	Socket (1/4 in Drive)
11.0 mm	22.2 mm (0.87 in)	200-8424	Socket (1/4 in Drive)
12.0 mm	22.2 mm (0.87 in)	200-8426	Socket (1/4 in Drive)
13.0 mm	22.2 mm (0.87 in)	200-8427	Socket (1/4 in Drive)
14.0 mm	22.2 mm (0.87 in)	200-8428	Socket (1/4 in Drive)
15.0 mm	23.0 mm (0.91 in)	200-8429	Socket (1/4 in Drive)

Ratchets and Sockets — Cat Sockets - 1/4 inch Drive

Metric Socket Set, 9 Piece, 1/4 inch Drive - 194-3578



Warranty: Lifetime

- 6 point
- 1/4 inch drive
- Deep length sockets
- Polished chrome finish
- Includes socket bar and clips

Size	Length	Part Number	Description
–	–	194-3578	Metric Socket Set
Socket Set Consists of:			
6.0 mm	50.8 mm (2 in)	194-3518	Socket (1/4 in Drive)
7.0 mm	50.8 mm (2 in)	194-3519	Socket (1/4 in Drive)
8.0 mm	50.8 mm (2 in)	194-3521	Socket (1/4 in Drive)
9.0 mm	50.8 mm (2 in)	194-3522	Socket (1/4 in Drive)

Size	Length	Part Number	Description
10.0 mm	50.8 mm (2 in)	194-3523	Socket (1/4 in Drive)
11.0 mm	50.8 mm (2 in)	194-3527	Socket (1/4 in Drive)
12.0 mm	50.8 mm (2 in)	194-3528	Socket (1/4 in Drive)
13.0 mm	50.8 mm (2 in)	194-3529	Socket (1/4 in Drive)
14.0 mm	50.8 mm (2 in)	194-3530	Socket (1/4 in Drive)

Ratchets and Sockets — Cat Sockets - 1/2 inch Drive

Fractional Socket Set, 12 Piece, 1/2 inch Drive - 214-6498



Warranty: Lifetime

- 6 point
- 1/2 inch square drive
- Standard length sockets
- Chrome finish
- Includes socket bar and clips
- Can be ordered by set or individually

Size	Length	Part Number	Description
–	–	214-6498	Socket Set
Socket Set Consists of:			
1 1/16 in	42.9 mm (1.69 in)	214-6513	Socket
1 1/8 in	44.5 mm (1.75 in)	214-6514	Socket
1 in	39.7 mm (1.56 in)	214-6512	Socket
1/2 in	38.1 mm (1.50 in)	214-6501	Socket
11/16 in	38.1 mm (1.50 in)	214-6506	Socket

Size	Length	Part Number	Description
13/16 in	38.1 mm (1.50 in)	214-6509	Socket
15/16 in	38.9 mm (1.53 in)	214-6511	Socket
3/4 in	38.1 mm (1.50 in)	214-6507	Socket
5/8 in	38.1 mm (1.50 in)	214-6504	Socket
7/16 in	38.1 mm (1.50 in)	214-6500	Socket
7/8 in	38.1 mm (1.50 in)	214-6510	Socket
9/16 in	38.1 mm (1.50 in)	214-6503	Socket

Fractional Deep Well Socket Set, 9 Piece, 1/2 inch Drive - 2P-5490



Warranty: Lifetime

- 6 point
- 1/2 inch square drive
- Chrome finish
- Includes socket bar and clips
- Can be ordered by set or individually

Size	Length	Part Number	Description
–	–	2P-5490	Deep Well Socket Set
Deep Well Socket Set Consists of:			
1/2 in	82.6 mm (3.25 in)	2P-5475	Socket
9/16 in	82.6 mm (3.25 in)	2P-5476	Socket
5/8 in	82.6 mm (3.25 in)	2P-5477	Socket

Size	Length	Part Number	Description
11/16 in	82.6 mm (3.25 in)	2P-5478	Socket
3/4 in	82.6 mm (3.25 in)	2P-5479	Socket
13/16 in	82.6 mm (3.25 in)	2P-5481	Spark Plug Wrench
7/8 in	82.6 mm (3.25 in)	2P-5482	Socket
15/16 in	82.6 mm (3.25 in)	2P-5483	Socket
1 in	82.6 mm (3.25 in)	2P-5484	Socket

Ratchets and Sockets — Cat Sockets - 1/2 inch Drive

Fractional Socket Set, 11 Piece, 1/2 inch Drive - 214-1161



Warranty: Lifetime

- 12 point
- 1/2 inch square drive
- Deep length sockets
- Polished chrome finish
- Includes socket bar and clips
- Can be ordered by set or individually

Size	Length	Part Number	Description
–	–	214-1161	Socket Set
Socket Set Consists of:			
1/2 in	82.6 mm (3.25 in)	214-1162	Socket
9/16 in	82.6 mm (3.25 in)	214-1163	Socket
5/8 in	82.6 mm (3.25 in)	214-1164	Socket
11/16 in	82.6 mm (3.25 in)	214-1165	Socket
3/4 in	82.6 mm (3.25 in)	214-1166	Socket

Size	Length	Part Number	Description
13/16 in	82.6 mm (3.25 in)	214-1167	Socket
7/8 in	82.6 mm (3.25 in)	214-1168	Socket
15/16 in	82.6 mm (3.25 in)	214-1169	Socket
1 in	82.6 mm (3.25 in)	214-1170	Socket
1 1/16 in	82.6 mm (3.25 in)	214-1171	Socket
1 1/8 in	82.6 mm (3.25 in)	214-1172	Socket

Metric Socket Set, 13 Piece, 1/2 inch Drive - 199-6156



Warranty: Lifetime

- 12 point
- 1/2 inch drive
- Standard length sockets
- Polished chrome finish
- Includes socket bar and clips
- Can be ordered by set or individually

Size	Length	Part Number	Description
–	–	199-6156	Metric Socket Set
Socket Set Consists of:			
12.0 mm	38.1 mm (1.50 in)	199-6149	Socket (1/2 in Drive)
13.0 mm	38.1 mm (1.50 in)	199-6150	Socket (1/2 in Drive)
14.0 mm	38.1 mm (1.50 in)	8T-3041	Socket (1/2 in Drive)
15.0 mm	38.1 mm (1.50 in)	6V-9110	Socket (1/2 in Drive)
16.0 mm	38.1 mm (1.50 in)	6V-9111	Socket (1/2 in Drive)
17.0 mm	38.1 mm (1.50 in)	6V-9112	Socket (1/2 in Drive)

Size	Length	Part Number	Description
18.0 mm	38.1 mm (1.50 in)	6V-9113	Socket (1/2 in Drive)
19.0 mm	38.1 mm (1.50 in)	6V-9114	Socket (1/2 in Drive)
20.0 mm	38.1 mm (1.50 in)	199-6152	Socket (1/2 in Drive)
21.0 mm	38.1 mm (1.50 in)	6V-9115	Socket (1/2 in Drive)
22.0 mm	38.1 mm (1.50 in)	6V-9116	Socket (1/2 in Drive)
23.0 mm	38.1 mm (1.50 in)	199-6153	Socket (1/2 in Drive)
24.0 mm	38.1 mm (1.50 in)	199-6154	Socket (1/2 in Drive)

Ratchets and Sockets — Cat Sockets - 1/2 inch Drive

Metric Socket Set, 10 Piece, 1/2 inch Drive - 194-3576



Warranty: Lifetime

- 12 point
- 1/2 inch drive
- Deep length sockets
- Polished chrome finish
- Includes socket bar and clips
- Can be ordered by set or individually

Size	Length	Part Number	Description
–	–	194-3576	Metric Socket Set
Socket Set Consists of:			
16.0 mm	82.6 mm (3.25 in)	194-3505	Socket (1/2 in Drive)
17.0 mm	82.6 mm (3.25 in)	194-3506	Socket (1/2 in Drive)
18.0 mm	82.6 mm (3.25 in)	194-3510	Socket (1/2 in Drive)
19.0 mm	82.6 mm (3.25 in)	194-3511	Socket (1/2 in Drive)

Size	Length	Part Number	Description
20.0 mm	82.6 mm (3.25 in)	194-3512	Socket (1/2 in Drive)
21.0 mm	82.6 mm (3.25 in)	194-3513	Socket (1/2 in Drive)
22.0 mm	82.6 mm (3.25 in)	194-3514	Socket (1/2 in Drive)
24.0 mm	82.6 mm (3.25 in)	194-3515	Socket (1/2 in Drive)
25.0 mm	82.6 mm (3.25 in)	194-3516	Socket (1/2 in Drive)
26.0 mm	82.6 mm (3.25 in)	194-3517	Socket (1/2 in Drive)

Ratchets and Sockets — Impact Socket Sets - 3/8 inch Drive

Fractional Impact Socket Set, 12 Piece, 3/8 inch Drive - 271-4600



Warranty: Lifetime

- 6 point
- 3/8 inch drive
- Standard length sockets
- Includes socket bar and clips
- Can be ordered by set or individually

Size	Length	Part Number	Description
–	–	271-4600	Impact Socket Set
Impact Socket Set Consists of:			
5/16 in	22.2 mm (0.87 in)	271-4601	Socket
3/8 in	23.8 mm (0.94 in)	271-4602	Socket
7/16 in	23.8 mm (0.94 in)	271-4603	Socket
1/2 in	23.8 mm (0.94 in)	271-4604	Socket
9/16 in	23.8 mm (0.94 in)	271-4605	Socket

Size	Length	Part Number	Description
5/8 in	23.8 mm (0.94 in)	271-4606	Socket
11/16 in	26.2 mm (1.03 in)	271-4607	Socket
3/4 in	26.2 mm (1.03 in)	271-4608	Socket
13/16 in	30.2 mm (1.19 in)	271-4609	Socket
7/8 in	32.5 mm (1.28 in)	271-4610	Socket
15/16 in	33.3 mm (1.31 in)	271-4611	Socket
1 in	25.4 mm (1 in)	271-4612	Socket

Fractional Impact Socket Set, 7 Piece, 3/8 inch Drive - 271-4613



Warranty: Lifetime

- 12 point
- 3/8 inch drive
- Standard length sockets
- Includes socket bar and clips
- Can be ordered by set or individually

Size	Length	Part Number	Description
–	–	271-4613	Impact Socket Set
Impact Socket Set Consists of:			
3/8 in	22.2 mm (0.87 in)	271-4615	Socket
7/16 in	23.8 mm (0.94 in)	271-4616	Socket
1/2 in	23.8 mm (0.94 in)	271-4617	Socket

Size	Length	Part Number	Description
9/16 in	23.8 mm (0.94 in)	271-4618	Socket
5/8 in	23.8 mm (0.94 in)	271-4619	Socket
11/16 in	26.2 mm (1.03 in)	271-4620	Socket
3/4 in	26.2 mm (1.03 in)	271-4621	Socket

Ratchets and Sockets — Impact Socket Sets - 3/8 inch Drive

Fractional Impact Socket Set, 12 Piece, 3/8 inch Drive - 271-4669



Warranty: Lifetime

- 6 point
- 3/8 inch drive
- Deep length sockets
- Includes socket bar and clips
- Can be ordered by set or individually

Size	Length	Part Number	Description
–	–	271-4669	Impact Socket Set
Impact Socket Set Consists of:			
5/16 in	54.0 mm (2.13 in)	271-4670	Socket
3/8 in	54.0 mm (2.13 in)	271-4671	Socket
7/16 in	54.0 mm (2.13 in)	271-4672	Socket
1/2 in	54.0 mm (2.13 in)	271-4673	Socket
9/16 in	60.3 mm (2.37 in)	271-4674	Socket

Size	Length	Part Number	Description
5/8 in	60.3 mm (2.37 in)	271-4675	Socket
11/16 in	74.6 mm (2.94 in)	271-4676	Socket
3/4 in	69.9 mm (2.75 in)	271-4677	Socket
13/16 in	69.9 mm (2.75 in)	271-4678	Socket
7/8 in	69.9 mm (2.75 in)	271-4679	Socket
15/16 in	69.9 mm (2.75 in)	271-4680	Socket
1 in	69.9 mm (2.75 in)	271-4681	Socket

Metric Impact Socket Set, 14 Piece, 3/8 inch Drive - 271-4622



Warranty: Lifetime

- 6 point
- 3/8 inch drive
- Standard length sockets
- Includes socket bar and clips
- Can be ordered by set or individually

Size	Length	Part Number	Description
–	–	271-4622	Impact Socket Set
Socket Set Consists of:			
8.0 mm	23 mm (0.91 in)	271-4623	Socket (3/8 in Drive)
9.0 mm	23 mm (0.91 in)	271-4624	Socket (3/8 in Drive)
10.0 mm	23 mm (0.91 in)	271-4625	Socket (3/8 in Drive)
11.0 mm	23.8 mm (0.94 in)	271-4626	Socket (3/8 in Drive)
12.0 mm	23.8 mm (0.94 in)	271-4627	Socket (3/8 in Drive)
13.0 mm	24.6 mm (0.97 in)	271-4628	Socket (3/8 in Drive)

Size	Length	Part Number	Description
14.0 mm	27 mm (1.06 in)	271-4630	Socket (3/8 in Drive)
15.0 mm	27 mm (1.06 in)	271-4631	Socket (3/8 in Drive)
16.0 mm	27.8 mm (1.09 in)	271-4632	Socket (3/8 in Drive)
17.0 mm	28.2 mm (1.11 in)	271-4633	Socket (3/8 in Drive)
18.0 mm	29 mm (1.14 in)	271-4634	Socket (3/8 in Drive)
19.0 mm	30.6 mm (1.20 in)	271-4635	Socket (3/8 in Drive)
21.0 mm	29.5 mm (1.16 in)	271-4636	Socket (3/8 in Drive)
24.0 mm	33 mm (1.30 in)	271-4637	Socket (3/8 in Drive)

Ratchets and Sockets — Impact Socket Sets - 3/8 inch Drive

Metric Impact Socket Set, 14 Piece, 3/8 inch Drive - 271-4654

Warranty: Lifetime

- 12 point
- 3/8 inch drive
- Standard length sockets
- Includes socket bar and clips
- Can be ordered by set or individually



Size	Length	Part Number	Description
–	–	271-4654	Impact Socket Set
Impact Socket Set consists of:			
8.0 mm	23 mm (0.91 in)	271-4655	Socket (3/8 in Drive)
10.0 mm	23 mm (0.91 in)	271-4656	Socket (3/8 in Drive)
11.0 mm	23.8 mm (0.91 in)	271-4657	Socket (3/8 in Drive)
12.0 mm	23.8 mm (0.94 in)	271-4658	Socket (3/8 in Drive)
13.0 mm	23.8 mm (0.94 in)	271-4659	Socket (3/8 in Drive)
14.0 mm	27 mm (1.06 in)	271-4660	Socket (3/8 in Drive)

Size	Length	Part Number	Description
15.0 mm	27 mm (1.06 in)	271-4661	Socket (3/8 in Drive)
16.0 mm	27.8 mm (1.09 in)	271-4662	Socket (3/8 in Drive)
17.0 mm	28.2 mm (1.11 in)	271-4663	Socket (3/8 in Drive)
18.0 mm	29 mm (1.14 in)	271-4664	Socket (3/8 in Drive)
19.0 mm	30.6 mm (1.20 in)	271-4665	Socket (3/8 in Drive)
20.0 mm	30.9 mm (1.22 in)	271-4666	Socket (3/8 in Drive)
21.0 mm	32.1 mm (1.26 in)	271-4667	Socket (3/8 in Drive)
22.0 mm	32.9 mm (1.30 in)	271-4668	Socket (3/8 in Drive)

Metric Impact Socket Set, 14 Piece, 3/8 inch Drive - 271-4638

Warranty: Lifetime

- 6 point
- 3/8 inch drive
- Deep length sockets
- Includes socket bar and clips
- Can be ordered by set or individually



Size	Length	Part Number	Description
–	–	271-4638	Impact Socket Set
Impact Socket Set Consists of:			
8.0 mm	54 mm (2.13 in)	271-4639	Socket (3/8 in Drive)
9.0 mm	54 mm (2.13 in)	271-4640	Socket (3/8 in Drive)
10.0 mm	54 mm (2.13 in)	271-4641	Socket (3/8 in Drive)
11.0 mm	54 mm (2.13 in)	271-4642	Socket (3/8 in Drive)
12.0 mm	54 mm (2.13 in)	271-4643	Socket (3/8 in Drive)
13.0 mm	54 mm (2.13 in)	271-4644	Socket (3/8 in Drive)

Size	Length	Part Number	Description
14.0 mm	60.3 mm (2.37 in)	271-4645	Socket (3/8 in Drive)
15.0 mm	60.3 mm (2.37 in)	271-4646	Socket (3/8 in Drive)
16.0 mm	60.3 mm (2.37 in)	271-4647	Socket (3/8 in Drive)
17.0 mm	66.7 mm (2.63 in)	271-4648	Socket (3/8 in Drive)
18.0 mm	66.7 mm (2.63 in)	271-4650	Socket (3/8 in Drive)
19.0 mm	66.7 mm (2.63 in)	271-4651	Socket (3/8 in Drive)
21.0 mm	66.7 mm (2.63 in)	271-4652	Socket (3/8 in Drive)
24.0 mm	73 mm (2.87 in)	271-4653	Socket (3/8 in Drive)

Ratchets and Sockets — Impact Socket Sets - 3/8 inch Drive

Metric Impact Socket Set, 14 Piece, 3/8 inch Drive - 271-4683



Warranty: Lifetime

- 12 point
- 3/8 inch drive
- Deep length sockets
- Includes socket bar and clips
- Can be ordered by set or individually

Size	Length	Part Number	Description
–	–	271-4683	Impact Socket Set
Impact Socket Set Consists of:			
8.0 mm	54 mm (2.13 in)	271-4684	Socket (3/8 in Drive)
9.0 mm	54 mm (2.13 in)	271-4685	Socket (3/8 in Drive)
10.0 mm	54 mm (2.13 in)	271-4686	Socket (3/8 in Drive)
11.0 mm	54 mm (2.13 in)	271-4687	Socket (3/8 in Drive)
12.0 mm	54 mm (2.13 in)	271-4688	Socket (3/8 in Drive)
13.0 mm	54 mm (2.13 in)	271-4689	Socket (3/8 in Drive)

Size	Length	Part Number	Description
14.0 mm	60.3 mm (2.37 in)	271-4690	Socket (3/8 in Drive)
15.0 mm	60.3 mm (2.37 in)	271-4691	Socket (3/8 in Drive)
16.0 mm	60.3 mm (2.37 in)	271-4692	Socket (3/8 in Drive)
17.0 mm	66.7 mm (2.63 in)	271-4693	Socket (3/8 in Drive)
18.0 mm	66.7 mm (2.63 in)	271-4694	Socket (3/8 in Drive)
19.0 mm	66.7 mm (2.63 in)	271-4695	Socket (3/8 in Drive)
21.0 mm	66.7 mm (2.63 in)	271-4696	Socket (3/8 in Drive)
24.0 mm	73 mm (2.87 in)	271-4697	Socket (3/8 in Drive)

Ratchets and Sockets — Impact Socket Sets - 1/2 in Square Drive

Fractional Impact Socket Set, 11 Piece 1/2 inch Drive - 213-3086



Warranty: Lifetime

- 6 point
- 1/2 inch square drive
- Standard length sockets
- Black oxide finish
- Includes socket bar and clips
- Can be ordered by set or individually

Size	Length	Part Number	Description
–	–	213-3086	Impact Socket Set
Impact Socket Set Consists of:			
1/2 in	38.1 mm (1.50 in)	213-3087	Socket
9/16 in	38.1 mm (1.50 in)	213-3088	Socket
5/8 in	38.1 mm (1.50 in)	213-3089	Socket
11/16 in	38.1 mm (1.50 in)	213-3091	Socket
3/4 in	38.1 mm (1.50 in)	213-3094	Socket

Size	Length	Part Number	Description
13/16 in	38.1 mm (1.50 in)	213-3099	Socket
7/8 in	38.1 mm (1.50 in)	213-3102	Socket
15/16 in	44.5 mm (1.75 in)	213-3104	Socket
1 in	44.5 mm (1.75 in)	213-3107	Socket
1 1/16 in	50.8 mm (2 in)	213-3109	Socket
1 1/8 in	50.8 mm (2 in)	213-3110	Socket, 1 1/8 in

Fractional Impact Socket Set, 12 Piece 1/2 inch Drive - 213-3515



Warranty: Lifetime

- 6 point
- 1/2 inch square drive
- Deep length sockets
- Black oxide finish
- Includes socket bar and clips
- Can be ordered by set or individually

Size	Length	Part Number	Description
–	–	213-3515	Impact Socket Set
Impact Socket Set Consists of:			
7/16 in	82.6 mm (3.25 in)	213-3516	Socket
1/2 in	82.6 mm (3.25 in)	213-3517	Socket
9/16 in	82.6 mm (3.25 in)	213-3518	Socket
5/8 in	82.6 mm (3.25 in)	213-3520	Socket
11/16 in	82.6 mm (3.25 in)	213-3521	Socket

Size	Length	Part Number	Description
3/4 in	82.6 mm (3.25 in)	213-3522	Socket
13/16 in	82.6 mm (3.25 in)	213-3523	Socket
7/8 in	88.9 mm (3.50 in)	213-3524	Socket
15/16 in	88.9 mm (3.50 in)	213-3525	Socket
1 in	88.9 mm (3.50 in)	213-3526	Socket
1 1/16 in	88.9 mm (3.50 in)	213-3528	Socket
1 1/8 in	88.9 mm (3.50 in)	213-3530	Socket

Ratchets and Sockets — Impact Socket Sets - 1/2 in Square Drive

Metric Impact Socket Set, 12 Piece 1/2 inch Drive - 213-6923



Warranty: Lifetime

- 6 point
- 1/2 inch drive
- Standard length impact sockets
- Black oxide finish
- Includes socket bar and clips
- Can be ordered by set or individually

Size	Length	Part Number	Description
–	–	213-6923	Impact Socket Set
Socket Set Consists of:			
10.0 mm	38.1 mm (1.50 in)	213-6926	Impact Socket (1/2 in Drive)
11.0 mm	38.1 mm (1.50 in)	213-6927	Impact Socket (1/2 in Drive)
12.0 mm	38.1 mm (1.50 in)	213-6928	Impact Socket (1/2 in Drive)
13.0 mm	38.1 mm (1.50 in)	213-6929	Impact Socket (1/2 in Drive)
14.0 mm	38.1 mm (1.50 in)	213-6930	Impact Socket (1/2 in Drive)
15.0 mm	38.1 mm (1.50 in)	213-6932	Impact Socket

Size	Length	Part Number	Description
			(1/2 in Drive)
16.0 mm	38.1 mm (1.50 in)	213-6933	Impact Socket (1/2 in Drive)
17.0 mm	38.1 mm (1.50 in)	213-6934	Impact Socket (1/2 in Drive)
18.0 mm	38.1 mm (1.50 in)	213-6935	Impact Socket (1/2 in Drive)
19.0 mm	38.1 mm (1.50 in)	213-6936	Impact Socket (1/2 in Drive)
20.0 mm	38.1 mm (1.50 in)	213-6924	Impact Socket (1/2 in Drive)
21.0 mm	38.1 mm (1.50 in)	213-6937	Impact Socket (1/2 in Drive)

Metric Impact Socket Set, 11 Piece 1/2 inch Drive - 214-6643



Warranty: Lifetime

- 6 point
- 1/2 inch drive
- Deep length impact sockets
- Black oxide finish
- Includes socket bar and clips
- Can be ordered by set or individually

Size	Length	Part Number	Description
–	–	214-6643	Impact Socket Set
Impact Socket Set Consists of:			
10.0 mm	82.6 mm (3.25 in)	214-6644	Impact Socket (1/2 in Drive)
11.0 mm	82.6 mm (3.25 in)	214-6645	Impact Socket (1/2 in Drive)
12.0 mm	82.6 mm (3.25 in)	214-6646	Impact Socket (1/2 in Drive)
13.0 mm	82.6 mm (3.25 in)	214-6647	Impact Socket (1/2 in Drive)

Size	Length	Part Number	Description
14.0 mm	82.6 mm (3.25 in)	214-6648	Impact Socket (1/2 in Drive)
15.0 mm	82.6 mm (3.25 in)	214-6649	Impact Socket (1/2 in Drive)
16.0 mm	82.6 mm (3.25 in)	214-6650	Impact Socket (1/2 in Drive)
17.0 mm	82.6 mm (3.25 in)	214-6651	Impact Socket (1/2 in Drive)
18.0 mm	82.6 mm (3.25 in)	214-6652	Impact Socket (1/2 in Drive)

Ratchets and Sockets — Impact Socket Sets - 1/2 in Square Drive

Metric Impact Socket Set, 11 Piece 1/2 inch Drive - 214-6643 (Cont'd.)

Size	Length	Part Number	Description	Size	Length	Part Number	Description
19.0 mm	82.6 mm (3.25 in)	214-6653	Impact Socket (1/2 in Drive)	20.0 mm	82.6 mm (3.25 in)	214-7346	Impact Socket (1/2 in Drive)

Ratchets and Sockets — Impact Socket Sets - 3/4 in Square Drive

Metric Impact Socket Set, 24 Piece 3/4 inch Drive - 9U-6547



Warranty: Lifetime

- 6 point
- 3/4 inch drive
- Standard length impact sockets
- Black oxide finish
- Can be ordered by set or individually

Size	Length	Part Number	Description
–	–	214-6643	Impact Socket Set
Impact Socket Set Consists of:			
17.0 mm	44.5 mm (1.75 in)	9U-6523	Impact Socket
19.0 mm	44.5 mm (1.75 in)	9U-6524	Impact Socket
20.0 mm	44.5 mm (1.75 in)	9U-6525	Impact Socket
21.0 mm	47.8 mm (1.88 in)	9U-6526	Impact Socket
22.0 mm	47.6 mm (1.87 in)	9U-6527	Impact Socket
23.0 mm	47.8 mm (1.88 in)	9U-6528	Impact Socket
24.0 mm	47.6 mm (1.87 in)	9U-6529	Impact Socket
26.0 mm	50.8 mm (2 in)	9U-6530	Impact Socket
27.0 mm	50.8 mm (2 in)	9U-6531	Impact Socket
28.0 mm	53.8 mm (2.12 in)	9U-6532	Impact Socket
30.0 mm	53.8 mm (2.12 in)	9U-6533	Impact Socket

Size	Length	Part Number	Description
31.0 mm	54 mm (2.13 in)	9U-6534	Impact Socket
32.0 mm	54 mm (2.13 in)	9U-6535	Impact Socket
33.0 mm	53.8 mm (2.12 in)	9U-6536	Impact Socket
34.0 mm	54 mm (2.13 in)	9U-6537	Impact Socket
35.0 mm	57.2 mm (2.25 in)	9U-6538	Impact Socket
36.0 mm	57.2 mm (2.25 in)	9U-6539	Impact Socket
38.0 mm	57.2 mm (2.25 in)	9U-6540	Impact Socket
40.0 mm	66.7 mm (2.63 in)	9U-6541	Impact Socket
41.0 mm	66.5 mm (2.62 in)	9U-6542	Impact Socket
42.0 mm	66.5 mm (2.62 in)	9U-6543	Impact Socket
43.0 mm	66.5 mm (2.62 in)	9U-6544	Impact Socket
46.0 mm	66.7 mm (2.63 in)	9U-6545	Impact Socket
50.0 mm	73.2 mm (2.88 in)	9U-6546	Impact Socket

Universal and Swivel Socket Sets - 3/8 inch Square Drive

Fractional Universal Socket Set, 7 Piece, 3/8 inch Drive - 9S-1747

Warranty: Lifetime



- 12 point
- 3/8 inch universal drive
- Polished chrome finish
- Can be ordered by set or individually

Size	Length	Part Number	Description
–	–	9S-1747	Universal Socket Set
Socket Set Consists of:			
3/8 in	40.1 mm (1.58 in)	8S-2284	Universal Socket
7/16 in	40.1 mm (1.58 in)	8H-8562	Universal Socket

Size	Length	Part Number	Description
1/2 in	42.1 mm (1.66 in)	8H-8563	Universal Socket
9/16 in	42.8 mm (1.69 in)	8H-8564	Universal Socket
5/8 in	44.5 mm (1.75 in)	8H-8565	Universal Socket
11/16 in	49.6 mm (1.95 in)	9S-1727	Universal Socket
3/4 in	50.4 mm (1.98 in)	8H-8566	Universal Socket

Fractional Universal Socket Set, 7 Piece, 3/8 inch Drive - 261-8581



Warranty: Lifetime

- 6 point
- 3/8 inch square drive
- Includes socket bar and clips
- Can be ordered by set or individually

Size	Length	Part Number	Description
–	–	261-8581	Universal Impact Socket Set
Socket Set Consists of:			
3/8 in	50 mm (1.97 in)	261-8583	Socket
7/16 in	50 mm (1.97 in)	261-8585	Socket

Size	Length	Part Number	Description
1/2 in	54.1 mm (2.13 in)	261-8586	Socket
9/16 in	55.6 mm (2.19 in)	261-8587	Socket
5/8 in	57.2 mm (2.25 in)	261-8589	Socket
11/16 in	64.3 mm (2.53 in)	261-8590	Socket
3/4 in	65.8 mm (2.59 in)	261-8591	Socket

Universal and Swivel Socket Sets - 3/8 inch Square Drive

Metric Universal Socket Set, 9 Piece, 3/8 inch Drive - 9U-6124



SMCS Code: 1251-010, 0601

Warranty: Lifetime

- Model: 3066 Engine
- 9U-6128 used to remove and install fuel injection pump
- Standard length, 12 point universal socket set
- Specially forged and heat treated for toughness and long life—meets rigid industry standards
- Includes socket bar and clips
- Can be ordered by set or individually

Size	Length	Part Number	Description
—	—	9U-6124	Universal Metric Socket Set
Metric Socket Set Consists of:			
10.0 mm	43.5 mm (1.71 in)	9U-6125	Socket (3/8 in Drive)
12.0 mm	45.5 mm (1.79 in)	9U-6126	Socket (3/8 in Drive)
13.0 mm	45.5 mm (1.79 in)	9U-6127	Socket (3/8 in Drive)

Size	Length	Part Number	Description
14.0 mm	47.9 mm (1.89 in)	9U-6128	Socket (3/8 in Drive)
15.0 mm	47.9 mm (1.89 in)	9U-6129	Socket (3/8 in Drive)
16.0 mm	47.9 mm (1.89 in)	9U-6130	Socket (3/8 in Drive)
17.0 mm	50.7 mm (2 in)	9U-6131	Socket (3/8 in Drive)
18.0 mm	50.7 mm (2 in)	9U-6132	Socket (3/8 in Drive)
19.0 mm	52.5 mm (2.07 in)	9U-6133	Socket (3/8 in Drive)

Metric Universal Socket Set, 7 Piece, 3/8 inch Drive - 261-8572



Warranty: Lifetime

- 6 point
- 3/8 inch square drive
- Includes socket bar and clips
- Can be ordered by set or individually

Size	Length	Part Number	Description
—	—	261-8572	Metric Swivel Impact Socket Set
Metric Swivel Impact Set Consists of:			
10.0 mm	50.8 mm (2 in)	261-8573	Metric Swivel Impact Socket (3/8 in Drive)
12.0 mm	53.1 mm (2.09 in)	261-8574	Metric Swivel Impact Socket (3/8 in Drive)
13.0 mm	54.1 mm (2.13 in)	261-8575	Metric Swivel Impact Socket (3/8 in Drive)

Size	Length	Part Number	Description
14.0 mm	55.4 mm (2.18 in)	261-8576	Metric Swivel Impact Socket (3/8 in Drive)
15.0 mm	56.4 mm (2.22 in)	261-8577	Metric Swivel Impact Socket (3/8 in Drive)
17.0 mm	62.2 mm (2.45 in)	261-8578	Metric Swivel Impact Socket (3/8 in Drive)
18.0 mm	64 mm (2.52 in)	261-8579	Metric Swivel Impact Socket (3/8 in Drive)

Universal and Swivel Socket Sets - 1/2 inch Drive

Fractional Universal Impact Socket Set, 5 Piece, 1/2 inch Drive - 214-6518



Warranty: Lifetime

- 6 point
- 1/2 inch square drive
- Black oxide finish
- Includes socket bar and clips
- Can be ordered by set or individually

Size	Length	Part Number	Description
–	–	214-6518	Universal Impact Socket Set
Universal Impact Socket Set Consists of:			
1/2 in	73.8 mm (2.91 in)	214-6521	Socket

Size	Length	Part Number	Description
9/16 in	73.8 mm (2.91 in)	214-6522	Socket
5/8 in	73.8 mm (2.91 in)	214-6523	Socket
11/16 in	77.8 mm (3.06 in)	214-6524	Socket
3/4 in	77.8 mm (3.06 in)	214-6526	Socket

Fractional Universal Impact Socket Set, 14 Piece, 1/2 inch Drive - 246-8184



Warranty: Lifetime

- 6 point
- 1/2 inch square drive
- Black oxide finish
- Standard length impact sockets
- Includes socket bar and clips
- Can be ordered by set or individually

Size	Length	Part Number	Description
–	–	246-8184	Socket Set
Universal Impact Socket Set Consists of:			
1/2 in	73.8 mm (2.91 in)	214-6521	Socket
9/16 in	73.8 mm (2.91 in)	214-6522	Socket
5/8 in	73.8 mm (2.91 in)	214-6523	Socket
11/16 in	77.8 mm (3.06 in)	214-6524	Socket
3/4 in	77.8 mm (3.06 in)	214-6526	Socket
13/16 in	77.8 mm (3.06 in)	246-8173	Socket

Size	Length	Part Number	Description
7/8 in	77.8 mm (3.06 in)	246-8175	Socket
15/16 in	77.8 mm (3.06 in)	246-8176	Socket
1 in	77.8 mm (3.06 in)	246-8177	Socket
1 - 1/16 in	80.2 mm (3.16 in)	246-8178	Socket
1 - 1/8 in	84.9 mm (3.34 in)	246-8179	Socket
1 - 3/16 in	84.9 mm (3.34 in)	246-8180	Socket
1 - 1/4 in	86.5 mm (3.41 in)	246-8181	Socket
1 - 5/16 in	86.5 mm (3.41 in)	246-8182	Socket

Universal and Swivel Socket Sets - 1/2 inch Drive

Metric Universal Impact Socket Set, 10 Piece, 1/2 inch Drive - 246-8199



Warranty: Lifetime

- 6 point
- 1/2 inch square drive
- Black oxide finish
- Standard length impact sockets
- Includes socket bar and clips
- Can be ordered by set or individually

Size	Length	Part Number	Description
-		246-8199	Metric Universal Impact Socket Set
Metric Universal Impact Socket Set Consists of:			
10.0 mm	73.7 mm (2.90 in)	246-8185	Universal Impact Socket (1/2 in Drive)
11.0 mm	73.7 mm (2.90 in)	246-8186	Universal Impact Socket (1/2 in Drive)
12.0 mm	73.7 mm (2.90 in)	246-8187	Universal Impact Socket (1/2 in Drive)
13.0 mm	73.7 mm (2.90 in)	246-8188	Universal Impact Socket (1/2 in Drive)

Size	Length	Part Number	Description
14.0 mm	73.7 mm (2.90 in)	246-8189	Universal Impact Socket (1/2 in Drive)
15.0 mm	73.7 mm (2.90 in)	246-8190	Universal Impact Socket (1/2 in Drive)
16.0 mm	73.7 mm (2.90 in)	246-8191	Universal Impact Socket (1/2 in Drive)
17.0 mm	77.8 mm (3.06 in)	246-8192	Universal Impact Socket (1/2 in Drive)
18.0 mm	77.7 mm (3.06 in)	246-8194	Universal Impact Socket (1/2 in Drive)
19.0 mm	77.7 mm (3.06 in)	246-8197	Universal Impact Socket (1/2 in Drive)

Ratchets and Sockets — Twist Sockets - 3/8 inch Square Drive

Fractional Twist Socket Set, 13 Piece, 3/8 inch Drive - 241-0873



Warranty: Lifetime

- SAE / Metric impact sockets quickly and easily remove damaged or rounded nuts and bolts
- 6 fluted sockets grip onto fastener and tighten as more torque is applied (no hammering required to install socket over fastener)
- Applications include oil pan drain plugs, exhaust manifold nuts, studs, pipe nipples, and corroded marine fasteners
- Shallow depth
- Fits sizes from 10 to 19 mm (3/8 to 3/4 inch)
- 3/8 inch square drive
- Standard length
- Industrial black finish
- Includes plastic tray, socket bar, and clips
- Can be ordered by set or individual

Size	Length	Part Number	Description
–	–	241-0873	Twist Socket Set
Twist Socket Set Consists of:			
1/2 in	31.7 mm (1.25 in)	241-0868	Socket (3/8 in Drive)
10 mm	31.7 mm (1.25 in)	241-0860	Socket (3/8 in Drive)
11 mm	31.7 mm (1.25 in)	241-0867	Socket (3/8 in Drive)
11/16 in	34.9 mm (1.37 in)	241-0871	Socket (3/8 in Drive)
12 mm	31.7 mm (1.25 in)	241-0861	Socket (3/8 in Drive)
13 mm	31.7 mm (1.25 in)	241-0862	Socket (3/8 in Drive)

Size	Length	Part Number	Description
14 mm	31.7 mm (1.25 in)	241-0863	Socket (3/8 in Drive)
15 mm	31.7 mm (1.25 in)	241-0864	Socket (3/8 in Drive)
16 mm	31.7 mm (1.25 in)	241-0870	Socket (3/8 in Drive)
17 mm	31.7 mm (1.25 in)	241-0865	Socket (3/8 in Drive)
19 mm	34.9 mm (1.37 in)	241-0872	Socket (3/8 in Drive)
3/8 in	31.7 mm (1.25 in)	241-0866	Socket (3/8 in Drive)
9/16 in	31.7 mm (1.25 in)	241-0869	Socket (3/8 in Drive)

Ratchets and Sockets — Individual Sockets

Individual Fractional Sockets, 1/4 in Drive

Warranty: Lifetime

Size	Length	Part Number
1/4 inch Drive, Standard Length Sockets, 12 Point		
3/16 in	22.2 mm (0.87 in)	9S-1711
7/32 in	22.2 mm (0.87 in)	9S-1712
1/4 in	22.2 mm (0.87 in)	9S-1713
9/32 in	22.2 mm (0.87 in)	9S-1714
5/16 in	22.2 mm (0.87 in)	9S-1715
11/32 in	22.2 mm (0.87 in)	9S-1716
3/8 in	22.2 mm (0.87 in)	9S-1717
7/16 in	22.2 mm (0.87 in)	9S-1718
1/2 in	22.2 mm (0.87 in)	9S-1719
1/4 inch Drive, Deep Length Sockets, 6 Point, Chrome		
5/16 in	31.8 mm (1.25 in)	5P-0127
3/16 in	50.8 mm (2 in)	213-9967
7/32 in	50.8 mm (2 in)	213-9968
1/4 in	50.8 mm (2 in)	213-9969
9/32 in	50.8 mm (2 in)	213-9970
5/16 in	50.8 mm (2 in)	213-9971
11/32 in	50.8 mm (2 in)	213-9972
3/8 in	50.8 mm (2 in)	213-9974
7/16 in	50.8 mm (2 in)	213-9978
1/2 in	50.8 mm (2 in)	213-9980
9/16 in	50.8 mm (2 in)	213-9981
1/4 inch Drive, Deep Length Socket, 12 Point		
3/8 in	50.8 mm (2 in)	9S-2573

Individual Fractional Sockets, 3/8 in Drive

Warranty: Lifetime

Size	Length	Part Number
3/8 inch Drive, Universal Sockets, 12 Point		
7/16 in	40.1 mm (1.58 in)	8H-8562
3/8 in	40.1 mm (1.58 in)	8S-2284
1/2 in	42.1 mm (1.66 in)	8H-8563
9/16 in	42.8 mm (1.69 in)	8H-8564
5/8 in	44.5 mm (1.75 in)	8H-8565
11/16 in	49.6 mm (1.95 in)	9S-1727

Ratchets and Sockets — Individual Sockets

Individual Fractional Sockets, 3/8 in Drive (Cont'd.)

Size	Length	Part Number
3/4 in	50.4 mm (1.98 in)	8H-8566
3/8 inch Drive, Standard Length Sockets, 12 Point		
1/4 in	23 mm (0.91 in)	266-3738
5/16 in	23 mm (0.91 in)	266-3739
7/16 in	23 mm (0.91 in)	8H-8567
3/8 in	23 mm (0.91 in)	8S-2274
1/2 in	23.8 mm (0.94 in)	8H-8568
9/16 in	24.6 mm (0.97 in)	8H-8569
5/8 in	26.2 mm (1.03 in)	8H-8570
11/16 in	27 mm (1.06 in)	9S-1728
3/4 in	27.8 mm (1.09 in)	8H-8571
1/4 in ⁽¹⁾	31.8 mm (1.25 in)	8S-1589
5/16 in ⁽¹⁾	31.8 mm (1.25 in)	8S-1590
3/8 in	38.1 mm (1.50 in)	8S-1591
7/16 in	38.1 mm (1.50 in)	8S-1592
3/8 inch Drive, Deep Length Sockets, 12 Point, Chrome		
7/16 in	54 mm (2.13 in)	3P-2210 ⁽²⁾
3/8 in	54.1 mm (2.13 in)	214-6491
7/16 in	54.1 mm (2.13 in)	214-6492
1/2 in	60.5 mm (2.38 in)	214-6493
9/16 in	60.5 mm (2.38 in)	8S-2357
5/8 in ⁽³⁾	60.5 mm (2.38 in)	9S-5031 ⁽³⁾
11/16 in	66.8 mm (2.63 in)	214-6494
3/4 in	66.8 mm (2.63 in)	214-6495
13/16 in	69.9 mm (2.75 in)	214-6496
7/8 in	69.9 mm (2.75 in)	6V-0199
3/8 inch Drive, Standard Length Sockets, 6 Point, Chrome		
3/8 in	23.1 mm (0.91 in)	214-1144
7/16 in	23.1 mm (0.91 in)	214-1145

1 Shoulder bolt socket 12 point

2 Special socket

3 Comes with insert for removing spark plugs

Ratchets and Sockets — Individual Sockets

Individual Fractional Sockets, 3/8 in Drive (Cont'd.)

Size	Length	Part Number
1/2 in	23.9 mm (0.94 in)	214-1146
9/16 in	26.2 mm (1.03 in)	214-1147
5/8 in	27.7 mm (1.09 in)	214-1148
11/16 in	28.7 mm (1.13 in)	214-1149
3/4 in	30.2 mm (1.19 in)	214-1150
3/8 inch Drive, Deep Length Sockets, 6 Point, Chrome		
3/8 in	54 mm (2.13 in)	214-1152
7/16 in	54 mm (2.13 in)	214-1153
1/2 in	60.3 mm (2.37 in)	214-1154
9/16 in	60.3 mm (2.37 in)	214-1155
5/8 in	60.3 mm (2.37 in)	214-1156
11/16 in	66.7 mm (2.63 in)	214-1157
3/4 in	66.7 mm (2.63 in)	214-1158
13/16 in	69.9 mm (2.75 in)	214-1159
7/8 in	69.9 mm (2.75 in)	214-1160
3/8 inch Drive, Standard Length Impact Sockets, 6 Point		
5/16 in	22.2 mm (0.87 in)	271-4601
3/8 in	23.8 mm (0.94 in)	271-4602
7/16 in	23.8 mm (0.94 in)	271-4603
1/2 in	23.8 mm (0.94 in)	271-4604
9/16 in	23.8 mm (0.94 in)	271-4605
5/8 in	23.8 mm (0.94 in)	271-4606
1 in	25.4 mm (1 in)	271-4612
11/16 in	26.2 mm (1.03 in)	271-4607
3/4 in	26.2 mm (1.03 in)	271-4608
13/16 in	30.2 mm (1.19 in)	271-4609
7/8 in	32.5 mm (1.28 in)	271-4610
15/16 in	33.3 mm (1.31 in)	271-4611
3/8 inch Drive, Deep Length Impact Sockets, 12 Point		
3/8 in	22.2 mm (0.87 in)	271-4615
7/16 in	23.8 mm (0.94 in)	271-4616
1/2 in	23.8 mm (0.94 in)	271-4617

Ratchets and Sockets — Individual Sockets

Individual Fractional Sockets, 3/8 in Drive (Cont'd.)

Size	Length	Part Number
9/16 in	23.8 mm (0.94 in)	271-4618
5/8 in	23.8 mm (0.94 in)	271-4619
11/16 in	26.2 mm (1.03 in)	271-4620
3/4 in	26.2 mm (1.03 in)	271-4621
3/8 inch Drive, Deep Length Impact Sockets, 6 Point		
5/16 in	54 mm (2.13 in)	271-4670
3/8 in	54 mm (2.13 in)	271-4671
7/16 in	54 mm (2.13 in)	271-4672
1/2 in	54 mm (2.13 in)	271-4673
9/16 in	60.3 mm (2.37 in)	271-4674
5/8 in	60.3 mm (2.37 in)	271-4675
3/4 in	69.9 mm (2.75 in)	271-4677
13/16 in	69.9 mm (2.75 in)	271-4678
7/8 in	69.9 mm (2.75 in)	271-4679
15/16 in	69.9 mm (2.75 in)	271-4680
1 in	69.9 mm (2.75 in)	271-4681
11/16 in	74.6 mm (2.94 in)	271-4676

Individual Fractional Sockets, 1/2 in Drive

Warranty: Lifetime

Size	Length	Part Number
1/2 inch Drive, Standard Length Sockets, 12 Point		
1/2 in	38.1 mm (1.50 in)	1S-0259
7/16 in	38.1 mm (1.50 in)	214-6497
9/16 in	38.1 mm (1.50 in)	8H-8549
5/8 in	38.1 mm (1.50 in)	8H-8550
11/16 in	38.1 mm (1.50 in)	8H-8551
3/4 in	38.1 mm (1.50 in)	8H-8552
13/16 in	38.1 mm (1.50 in)	8H-8553
7/8 in	38.1 mm (1.50 in)	8H-8554
15/16 in	38.1 mm (1.50 in)	8H-8555
1 in	38.1 mm (1.50 in)	8H-8556
1 1/16 in	41.3 mm (1.63 in)	9S-1729
1/2 in	44.5 mm (1.75 in)	8S-1593

Ratchets and Sockets — Individual Sockets

Individual Fractional Sockets, 1/2 in Drive (Cont'd.)

Size	Length	Part Number
9/16 in	44.5 mm (1.75 in)	8S-1594
5/8 in	44.5 mm (1.75 in)	8S-1595
11/16 in	44.5 mm (1.75 in)	8S-1596
1 1/8 in	44.5 mm (1.75 in)	9S-1730
1 1/4 in	47.6 mm (1.87 in)	9S-1731
1/2 inch Drive, Standard Length Sockets, 6 Point, Chrome		
7/16 in	38.1 mm (1.50 in)	214-6500
1/2 in	38.1 mm (1.50 in)	214-6501
9/16 in	38.1 mm (1.50 in)	214-6503
5/8 in	38.1 mm (1.50 in)	214-6504
11/16 in	38.1 mm (1.50 in)	214-6506
3/4 in	38.1 mm (1.50 in)	214-6507
13/16 in	38.1 mm (1.50 in)	214-6509
7/8 in	38.1 mm (1.50 in)	214-6510
15/16 in	38.9 mm (1.53 in)	214-6511
1 in	39.7 mm (1.56 in)	214-6512
1 11/16 in	42.9 mm (1.69 in)	214-6513
1 1/8 in	44.5 mm (1.75 in)	214-6514
1/2 inch Drive, Deep Length Sockets, 12 Point		
1 in	82.6 mm (3.25 in)	214-1162
9 in	82.6 mm (3.25 in)	214-1163
5 in	82.6 mm (3.25 in)	214-1164
11 in	82.6 mm (3.25 in)	214-1165
3 in	82.6 mm (3.25 in)	214-1166
13 in	82.6 mm (3.25 in)	214-1167
7 in	82.6 mm (3.25 in)	214-1168
15 in	82.6 mm (3.25 in)	214-1169
1 in	82.6 mm (3.25 in)	214-1170
1 1/8 in	82.6 mm (3.25 in)	214-1172
1 11/16 in	82.6 mm (3.25 in)	214-1171
1 1/2 in	133.35 mm (5.25 in)	386-3335
1/2 inch Drive, Deep Length Sockets, 6 Point		
1/2 in	82.6 mm (3.25 in)	2P-5475
9/16 in	82.6 mm (3.25 in)	2P-5476
5/8 in	82.6 mm (3.25 in)	2P-5477
11/16 in	82.6 mm (3.25 in)	2P-5478
3/4 in	82.6 mm (3.25 in)	2P-5479
13/16 in	82.6 mm (3.25 in)	2P-5481
7/8 in	82.6 mm (3.25 in)	2P-5482
15/16 in	82.6 mm (3.25 in)	2P-5483

Ratchets and Sockets — Individual Sockets

Individual Fractional Sockets, 1/2 in Drive (Cont'd.)

Size	Length	Part Number
1 in	82.6 mm (3.25 in)	2P-5484
1/2 inch Drive, Standard Length Impact Sockets, 6 Point, Black		
1/2 in	38.1 mm (1.50 in)	213-3087
9/16 in	38.1 mm (1.50 in)	213-3088
5/8 in	38.1 mm (1.50 in)	213-3089
11/16 in	38.1 mm (1.50 in)	213-3091
3/4 in	38.1 mm (1.50 in)	213-3094
13/16 in	38.1 mm (1.50 in)	213-3099
7/8 in	38.1 mm (1.50 in)	213-3102
15/16 in	44.5 mm (1.75 in)	213-3104
1 in	44.5 mm (1.75 in)	213-3107
1 1/16 in	50.8 mm (2 in)	213-3109
1 1/8 in	50.8 mm (2 in)	213-3110
1 1/18 in	82.6 mm (3.25 in)	323-6267
1/2 inch Drive, Universal Impact Sockets, 6 Point, Black		
1/2 in	73.8 mm (2.91 in)	214-6521
9/16 in	73.8 mm (2.91 in)	214-6522
5/8 in	73.8 mm (2.91 in)	214-6523
11/16 in	77.8 mm (3.06 in)	214-6524
3/4 in	77.8 mm (3.06 in)	214-6526
1/2 inch Drive, Deep Length Impact Sockets, 6 Point, Black		
7/16 in	82.6 mm (3.25 in)	213-3516
1/2 in	82.6 mm (3.25 in)	213-3517
9/16 in	82.6 mm (3.25 in)	213-3518
5/8 in	82.6 mm (3.25 in)	213-3520
11/16 in	82.6 mm (3.25 in)	213-3521
3/4 in	82.6 mm (3.25 in)	213-3522
13/16 in	82.6 mm (3.25 in)	213-3523
1 1/4 in	88.9 mm (3.50 in)	1U-8701
7/8 in	88.9 mm (3.50 in)	213-3524
15/16 in	88.9 mm (3.50 in)	213-3525
1 in	88.9 mm (3.50 in)	213-3526
1 1/16 in	88.9 mm (3.50 in)	213-3528
1 1/8 in	88.9 mm (3.50 in)	213-3530

Ratchets and Sockets — Individual Sockets

Individual Fractional Sockets, 3/4 in Drive

Warranty: Lifetime

Size	Length	Part Number
3/4 inch Drive, Standard Length Sockets, 12 Point		
1 3/8 in	35 mm (1.38 in)	386-3353
3/4 in	50.8 mm (2 in)	8H-8529
7/8 in	50.8 mm (2 in)	8H-8530
15/16 in	50.8 mm (2 in)	8H-8531
1 in	52.4 mm (2.06 in)	8H-8532
1 1/16 in	54 mm (2.13 in)	8H-8533
1 1/8 in	55.5 mm (2.19 in)	8H-8534
1 1/4 in	57.2 mm (2.25 in)	8H-8535
1 in	57.2 mm (2.25 in)	8S-1601
1 5/16 in	58.7 mm (2.31 in)	8H-8536
1 1/2 in	63.5 mm (2.50 in)	8H-8537
1 5/8 in	66.7 mm (2.63 in)	8H-8539
1 11/16 in	69.9 mm (2.75 in)	8H-8538
1 3/4 in	69.9 mm (2.75 in)	8H-8540
1 7/8 in	79.4 mm (3.13 in)	8H-8541
2 in	79.4 mm (3.13 in)	8H-8542
5/8 in ⁽⁴⁾	82.6 mm (3.25 in)	2P-8276
2 1/4 in	82.6 mm (3.25 in)	8H-8504
2 1/8 in	82.6 mm (3.25 in)	8H-8543
2 3/16 in	82.6 mm (3.25 in)	8H-8544
3/4 in	82.6 mm (3.25 in)	8S-1597
13/16 in	82.6 mm (3.25 in)	8S-1598
7/8 in	82.6 mm (3.25 in)	8S-1599
15/16 in	82.6 mm (3.25 in)	8S-1600
2 1/2 in ⁽⁵⁾	152.4 mm (6 in)	3P-2230
3/4 inch Drive, Standard Length Impact Sockets, 6 Point, Black		
3/4 in	44.5 mm (1.75 in)	214-6553
13/16 in	47.8 mm (1.88 in)	214-6554
7/8 in	47.8 mm (1.88 in)	214-6556
15/16 in	47.8 mm (1.88 in)	214-6557
1 in	50.8 mm (2 in)	214-6558
1 11/16 in	50.8 mm (2 in)	214-6559
1 1/8 in	54.1 mm (2.13 in)	214-6560
1 3/16 in	54.1 mm (2.13 in)	214-6561
1 1/4 in	54.1 mm (2.13 in)	214-6562

⁴ Shoulder bolt socket 12 point

⁵ Special socket for fast fill fuel adapter

Ratchets and Sockets — Individual Sockets

Individual Fractional Sockets, 3/4 in Drive (Cont'd.)

Size	Length	Part Number
1 5/16 in	57.2 mm (2.25 in)	214-6564
1 3/8 in	57.2 mm (2.25 in)	214-6565
1 7/16 in	57.2 mm (2.25 in)	214-6506
1 1/2 in	57.2 mm (2.25 in)	8T-5182
1 9/16 in	60.5 mm (2.38 in)	214-6567
1 5/8 in	60.5 mm (2.38 in)	214-6568
1 3/4 in	65 mm (2.56 in)	214-6569
1 11/16 in	65 mm (2.56 in)	214-6607
1 13/16 in	66.8 mm (2.63 in)	214-6570
1 7/8 in	69.9 mm (2.75 in)	214-6571
2 1/4 in	70 mm (2.75 in)	386-3266
2 in	73.2 mm (2.88 in)	214-6572
2 3/16 in	81 mm (3.18 in)	386-3267
2 3/8 in	89 mm (3.5 in)	386-3268
3/4 inch Drive, Deep Length Impact Sockets, 6 Point, Black		
1 in	76.2 mm (3 in)	214-6599
1 1/16 in	76.2 mm (3 in)	214-6600
1 1/8 in	76.2 mm (3 in)	214-6601
1 3/16 in	82.6 mm (3.25 in)	214-6602
1 1/4 in	82.6 mm (3.25 in)	214-6603
1 5/16 in	82.6 mm (3.25 in)	214-6604
1 3/8 in	82.6 mm (3.25 in)	214-6605
1 1/2 in	88.9 mm (3.50 in)	1U-5715
1 7/16 in	88.9 mm (3.50 in)	214-6606
1 9/16 in	88.9 mm (3.50 in)	214-6608
1 5/8 in	88.9 mm (3.50 in)	214-6609
1 3/4 in	88.9 mm (3.50 in)	214-6611
1 1/8 in	88.9 mm (3.50 in)	227-4397 ⁽⁶⁾
1 11/16 in	88.9 mm (3.50 in)	6V-7874
1 13/16 in	95.3 mm (3.75 in)	214-6612
1 7/8 in	95.3 mm (3.75 in)	214-6613
2 in Hex	95.3 mm (3.75 in)	214-6614
1 3/16 in	101.6 mm (4 in)	5P-3053 ⁽⁷⁾
1 1/2 in	127 mm (5 in)	5P-3054
3/4 inch Drive, Tapered Impact Sockets, 12 Point, Black		
3/4 in	127 mm (5 in)	124-0662
3/4 Inch Drive, Shallow, 12 Point, Black		
1 in	50.8 mm (2 in)	432-8907

6 Special use for 3406 Engine head service

7 Budd wheel socket

Ratchets and Sockets — Individual Sockets

Individual Fractional Sockets, 1 in Drive

Warranty: Lifetime

Size	Length	Part Number
1 inch Drive, Standard Length Sockets, 12 Point		
1 1/2 in	69.9 mm (2.75 in)	6V-0024
1 inch Drive, Standard Length Sockets, 6 Point, Black		
1 3/32 in ⁽⁸⁾	57.2 mm (2.25 in)	5P-3579
2 5/8 in ⁽⁹⁾	57.2 mm (2.25 in)	5S-6079
29/32 in ⁽⁸⁾	57.2 mm (2.25 in)	6V-2002
1 1/8 in ⁽⁸⁾	57.2 mm (2.25 in)	9S-6373
1 7/16 in	63.5 mm (2.50 in)	4C-6723
1 9/32 in ⁽⁸⁾	63.5 mm (2.50 in)	5P-3580
1 15/32 in ⁽⁸⁾	63.5 mm (2.50 in)	5P-3581
1 1/2 in ⁽⁸⁾	63.5 mm (2.50 in)	9S-6371
1 5/16 in ⁽⁸⁾	63.5 mm (2.50 in)	9S-6372
15/16 in ⁽¹⁰⁾	63.5 mm (2.50 in)	9S-6374
1 1/8 in ⁽¹⁰⁾	66.8 mm (2.63 in)	9S-6369
1 11/16 in	76.2 mm (3 in)	2P-2334
1 3/4 in	76.2 mm (3 in)	2P-2335
15/16 in ⁽⁸⁾	76.2 mm (3 in)	9S-6370
1 7/8 in	82.6 mm (3.25 in)	2P-2336
2 1/4 in ⁽¹¹⁾	87.1 mm (3.43 in)	5P-1748
7/8 in ⁽⁹⁾	88.9 mm (3.50 in)	5P-1745
27/32 in	88.9 mm (3.50 in)	6V-4175
7/8 in ⁽¹⁰⁾	88.9 mm (3.50 in)	9S-6375
4 1/4 in	90.4 mm (3.56 in)	5P-1662
2 3/16 in	91.9 mm (3.62 in)	2P-2338
2 3/8 in Hex	98.4 mm (3.87 in)	5S-6077
2 1/2 in ⁽⁹⁾	104.8 mm (4.13 in)	5S-6078
2 3/4 in ⁽⁹⁾	114.3 mm (4.50 in)	5S-6080
3 in ⁽⁹⁾	123.8 mm (4.87 in)	5S-6081
3 1/8 in ⁽⁹⁾	127 mm (5 in)	5S-6082
3 1/4 in ⁽⁹⁾	127 mm (5 in)	5S-6083
4 in ⁽⁹⁾	127 mm (5 in)	5S-6087
3 1/2 in ⁽⁹⁾	133.4 mm (5.25 in)	5S-6084
3 5/8 in ⁽⁹⁾	133.4 mm (5.25 in)	5S-6085

- 8 Track Bolt Socket, 6 point, Warranty: Six Months
- 9 Chrome finish
- 10 Thin wall track bolt socket, 6 point, Warranty: Six Months
- 11 Impact Socket, 6 point, Warranty: Six Months

Ratchets and Sockets — Individual Sockets

Individual Fractional Sockets, 1 in Drive (Cont'd.)

Size	Length	Part Number
3 3/4 in ⁽¹²⁾	136.5 mm (5.37 in)	5S-6086
1 inch Square Drive Standard Length Impact Sockets, 12 Point, Industrial Finish		
1 1/2 in	66.5 mm (2.62 in)	168-7955
1 inch Square Drive Standard Length Impact Sockets, 12 Point, Black Finish		
1 1/2 in	57.2 mm (2.25 in)	4C-6994
1 inch Square Drive Standard Length Impact Sockets, 6 Point, Industrial Finish		
3/4 in	54 mm (2.13 in)	9U-6548
13/16 in	54 mm (2.13 in)	9U-6549
7/8 in	54 mm (2.13 in)	9U-6550
15/16 in	54 mm (2.13 in)	9U-6551
1 1/4 in	54 mm (2.13 in)	386-3257
1 in	57.2 mm (2.25 in)	9U-6552
1 1/16 in	57.2 mm (2.25 in)	9U-6553
1 1/8 in	57.2 mm (2.25 in)	9U-6554
1 3/16 in	57.2 mm (2.25 in)	9U-6555
3 7/8 in	60 mm (2.36 in)	386-3259
1 5/16 in	63.5 mm (2.50 in)	9U-6557
1 3/8 in	63.5 mm (2.50 in)	9U-6558
1 7/16 in	63.5 mm (2.50 in)	9U-6559
1 1/2 in	66.7 mm (2.63 in)	9U-6560
1 9/16 in	66.7 mm (2.63 in)	9U-6561 ⁽¹³⁾
1 1/2 in	69.9 mm (2.75 in)	258-5686
1 5/8 in	69.9 mm (2.75 in)	9U-6562
1 11/16 in	73 mm (2.87 in)	9U-6563
1 3/4 in	73 mm (2.87 in)	9U-6564
1 13/16 in	74.6 mm (2.94 in)	9U-6565
1 7/8 in	74.6 mm (2.94 in)	9U-6566
1 15/16 in	74.6 mm (2.94 in)	9U-6567
1 13/16 in	74.6 mm (2.94 in)	386-3258
2 in	82.6 mm (3.25 in)	9U-6568
2 1/16 in	82.6 mm (3.25 in)	9U-6569
2 1/8 in	82.6 mm (3.25 in)	9U-6570
2 3/16 in	84.9 mm (3.34 in)	9U-6571
2 1/4 in	84.9 mm (3.34 in)	9U-6572
2 5/16 in	88.9 mm (3.50 in)	9U-6573
2 3/8 in	92.1 mm (3.63 in)	9U-6574
2 7/16 in	92.1 mm (3.63 in)	9U-6575
2 1/2 in	92.1 mm (3.63 in)	9U-6576

¹² Chrome finish

¹³ Used on 789 Off-Highway Truck cab support assemblies bolts

Ratchets and Sockets — Individual Sockets

Individual Fractional Sockets, 1 in Drive (Cont'd.)

Size	Length	Part Number
2 9/16 in	95.3 mm (3.75 in)	9U-6577
2 5/8 in	95.3 mm (3.75 in)	9U-6578
2 11/16 in	98.4 mm (3.87 in)	9U-6579
2 3/4 in	98.4 mm (3.87 in)	9U-6580
2 13/16 in	101.6 mm (4 in)	9U-6581
2 7/8 in	101.6 mm (4 in)	9U-6582
3 in	111.1 mm (4.37 in)	9U-6584
2 15/16 in	122.2 mm (4.81 in)	9U-6583
1 inch Square Drive Deep Length Impact Socket, 6 Point, Industrial Finish		
55 mm (2 3/16 in), 1 in drive, deep well, impact	111 mm (4.37 in)	4C-9748
1 3/16 in	111 mm (4.37 in)	4C-9787
4 in	368 mm (3 in)	447-1585
4 1/2 in	470 mm (3.375 in)	447-1586

Individual Fractional Sockets, 1 1/2 in Drive

Warranty: Lifetime

Size	Length	Part Number
1 1/2 inch Drive, Track Sockets, Impact Sockets		
1 7/16 in	77 mm (3.03 in)	386-3246
1 1/2 in	78 mm (3.07 in)	9U-6734 ⁽¹⁴⁾
1 5/8 in	114.3 mm (4.50 in)	1U-8798
1 11/16 in	114.3 mm (4.50 in)	1U-8586
1 3/4 in	83.3 mm (3.28 in)	386-3245
1 13/16 in	84.6 mm (3.33 in)	261-8571
1 7/8 in	85.7 mm (3.38 in)	386-3247
2 in	114.3 mm (4.50 in)	8T-9175
2 1/16 in	114.3 mm (4.50 in)	8T-9174
2 1/4 in	95.2 mm (3.75 in)	386-3225
2 3/8 in	98.4 mm (3.88 in)	386-3226
2 3/16 in	92.87 mm (3.66 in)	386-3249
2 9/16 in	102.4 mm (4.03 in)	132-8743
2 3/4 in	107.1 mm (4.22 in)	136-5190
3 in	112.7 mm (4.44 in)	386-3230
3 1/4 in	118.3 mm (4.66 in)	231-4550 ⁽¹⁵⁾
3 1/2 in	124.6 mm (4.91 in)	386-3227

¹⁴ Special for 994 Lift Cylinder

¹⁵ Special for 797 Off-Highway Truck Ball Studs

Ratchets and Sockets — Individual Sockets

Individual Fractional Sockets, 1 1/2 in Drive (Cont'd.)

Size	Length	Part Number
3 3/4 in	130.2 mm (5.13 in)	386-3228
3 7/8 in	133.4 mm (5.25 in)	386-3229
4 in	137.3 mm (5.41 in)	386-3232
4 1/4 in	152.4 mm (6 in)	234-6041 ⁽¹⁶⁾
4 5/8 in	154 mm (6.06 in)	386-3231
5 in	171.5 mm (6.75 in)	386-3234

Individual Metric Sockets, 1/4 in Drive

Warranty: Lifetime unless otherwise noted

Size	Length	Part Number
1/4 inch Drive, Standard Length Sockets, 6 Point		
4 mm	22.2 mm (0.87 in)	200-8415
5 mm	22.2 mm (0.87 in)	200-8417
5 mm	22.2 mm (0.87 in)	200-8418
6 mm	22.2 mm (0.87 in)	200-8419
7 mm	22.2 mm (0.87 in)	200-8420
8 mm	22.2 mm (0.87 in)	200-8421
9 mm	22.2 mm (0.87 in)	200-8422
10 mm	22.2 mm (0.87 in)	200-8423
11 mm	22.2 mm (0.87 in)	200-8424
12 mm	22.2 mm (0.87 in)	200-8426
13 mm	22.2 mm (0.87 in)	200-8427
14 mm	22.2 mm (0.87 in)	200-8428
15 mm	23 mm (0.91 in)	200-8429
1/4 inch Drive, Deep Length Sockets, 6 Point		
6 mm	50.8 mm (2 in)	194-3518
7 mm	50.8 mm (2 in)	194-3519
8 mm	50.8 mm (2 in)	194-3521
9 mm	50.8 mm (2 in)	194-3522
10 mm	50.8 mm (2 in)	194-3523
11 mm	50.8 mm (2 in)	194-3527
12 mm	50.8 mm (2 in)	194-3528
13 mm	50.8 mm (2 in)	194-3529
14 mm	50.8 mm (2 in)	194-3530

Ratchets and Sockets — Individual Sockets

Individual Metric Sockets, 3/8 in Drive

Warranty: Lifetime unless otherwise noted

Size	Length	Part Number
3/8 inch Drive, Standard Length Sockets, 12 Point		
8 mm	23 mm (0.91 in)	194-3480
9 mm	23 mm (0.91 in)	194-3483
10 mm	23 mm (0.91 in)	194-3488
11 mm	23 mm (0.91 in)	194-3490
12 mm	23.8 mm (0.94 in)	194-3492
18 mm	66.7 mm (2.63 in)	199-9034
19 mm	66.7 mm (2.63 in)	199-9035
3/8 inch Drive, Standard Length Sockets, 6 Point		
8 mm	23 mm (0.91 in)	214-6621
9 mm	23 mm (0.91 in)	214-6623
10 mm	23 mm (0.91 in)	214-6624
11 mm	23 mm (0.91 in)	214-6625
12 mm	23.8 mm (0.94 in)	214-6626
13 mm	24.6 mm (0.97 in)	214-6627
14 mm	26.2 mm (1.03 in)	214-6628
16 mm	27.8 mm (1.09 in)	214-6630
15 mm	27 mm (1.06 in)	214-6629
17 mm	28.6 mm (1.13 in)	214-6631
18 mm	28.6 mm (1.13 in)	214-6632
19 mm	30.2 mm (1.19 in)	214-6633
3/8 inch Drive, Deep Length Sockets, 6 Point		
10 mm	54 mm (2.13 in)	214-6635
11 mm	54 mm (2.13 in)	214-6636
12 mm	54 mm (2.13 in)	214-6637
13 mm	54 mm (2.13 in)	214-6638
14 mm	60.3 mm (2.37 in)	214-6639
15 mm	60.3 mm (2.37 in)	214-6640
17 mm	66.7 mm (2.63 in)	214-6641
19 mm	66.7 mm (2.63 in)	214-6642
3/8 inch Drive, Universal Standard Length Sockets, 12 Point		
10 mm	43.5 mm (1.71 in)	9U-6125
12 mm	45.5 mm (1.79 in)	9U-6126
13 mm	45.5 mm (1.79 in)	9U-6127
14 mm	47.9 mm (1.89 in)	9U-6128
15 mm	47.9 mm (1.89 in)	9U-6129
16 mm	47.9 mm (1.89 in)	9U-6130
17 mm	50.7 mm (2 in)	9U-6131
18 mm	50.7 mm (2 in)	9U-6132

Ratchets and Sockets — Individual Sockets

Individual Metric Sockets, 3/8 in Drive (Cont'd.)

Size	Length	Part Number
19 mm	52.5 mm (2.07 in)	9U-6133
3/8 inch Drive, Impact Standard Length Sockets, 12 Point		
8 mm	23 mm (0.91 in)	271-4655
10 mm	23 mm (0.91 in)	271-4656
11 mm	23.8 mm (0.94 in)	271-4657
12 mm	23.8 mm (0.94 in)	271-4658
13 mm	23.8 mm (0.94 in)	271-4659
14 mm	27 mm (1.06 in)	271-4660
15 mm	27 mm (1.06 in)	271-4661
16 mm	27.8 mm (1.09 in)	271-4662
17 mm	28.2 mm (1.11 in)	271-4663
18 mm	29 mm (1.14 in)	271-4664
19 mm	30.6 mm (1.20 in)	271-4665
20 mm	30.9 mm (1.22 in)	271-4666
21 mm	32.1 mm (1.26 in)	271-4667
22 mm	32.9 mm (1.30 in)	271-4668
3/8 inch Drive, Impact Standard Length Sockets, 6 Point		
8 mm	23 mm (0.91 in)	271-4623
9 mm	23 mm (0.91 in)	271-4624
10 mm	23 mm (0.91 in)	271-4625
11 mm	23.8 mm (0.94 in)	271-4626
12 mm	23.8 mm (0.94 in)	271-4627
13 mm	24.6 mm (0.97 in)	271-4628
14 mm	27 mm (1.06 in)	271-4630
15 mm	27 mm (1.06 in)	271-4631
16 mm	27.8 mm (1.09 in)	271-4632
17 mm	28.2 mm (1.11 in)	271-4633
18 mm	29 mm (1.14 in)	271-4634
19 mm	30.6 mm (1.20 in)	271-4635
21 mm	29.5 mm (1.16 in)	271-4636
24 mm	33 mm (1.30 in)	271-4637
3/8 inch Drive, Impact Deep Length Sockets, 12 Point		
8 mm	54 mm (2.13 in)	271-4684
9 mm	54 mm (2.13 in)	271-4685
10 mm	54 mm (2.13 in)	271-4686
11 mm	54 mm (2.13 in)	271-4687
12 mm	54 mm (2.13 in)	271-4688
13 mm	54 mm (2.13 in)	271-4689
14 mm	60.3 mm (2.37 in)	271-4690
15 mm	60.3 mm (2.37 in)	271-4691

Ratchets and Sockets — Individual Sockets

Individual Metric Sockets, 3/8 in Drive (Cont'd.)

Size	Length	Part Number
16 mm	60.3 mm (2.37 in)	271-4692
17 mm	66.7 mm (2.63 in)	271-4693
18 mm	66.7 mm (2.63 in)	271-4694
19 mm	66.7 mm (2.63 in)	271-4695
21 mm	66.7 mm (2.63 in)	271-4696
24 mm	73 mm (2.87 in)	271-4697
3/8 inch Drive, Impact Deep Length Sockets 6 Point		
8 mm	54 mm (2.13 in)	271-4639
9 mm	54 mm (2.13 in)	271-4640
10 mm	54 mm (2.13 in)	271-4641
11 mm	54 mm (2.13 in)	271-4642
12 mm	54 mm (2.13 in)	271-4643
13 mm	54 mm (2.13 in)	271-4644
14 mm	60.3 mm (2.37 in)	271-4645
15 mm	60.3 mm (2.37 in)	271-4646
16 mm	60.3 mm (2.37 in)	271-4647
17 mm	66.7 mm (2.63 in)	271-4648
18 mm	66.7 mm (2.63 in)	271-4650
19 mm	66.7 mm (2.63 in)	271-4651
21 mm	66.7 mm (2.63 in)	271-4652
24 mm	73 mm (2.87 in)	271-4653

Individual Metric Sockets, 1/2 in Drive

Warranty: Lifetime unless otherwise noted

Size	Length	Part Number
1/2 inch Drive, Deep Length Sockets, 6 Point		
36 mm ⁽¹⁷⁾	88.9 mm (3.50 in)	242-0779
1/2 inch Drive, Standard Length Sockets, 12 Point		
12 mm	38.1 mm (1.50 in)	199-6149
13 mm	38.1 mm (1.50 in)	199-6150
14 mm	38.1 mm (1.50 in)	8T-3041
15 mm	38.1 mm (1.50 in)	6V-9110
16 mm	38.1 mm (1.50 in)	6V-9111
17 mm	38.1 mm (1.50 in)	6V-9112

¹⁷ Warranty: Manufacturer, 120 Day

Ratchets and Sockets — Individual Sockets

Individual Metric Sockets, 1/2 in Drive (Cont'd.)

Size	Length	Part Number
18 mm	38.1 mm (1.50 in)	6V-9113
19 mm	38.1 mm (1.50 in)	6V-9114
20 mm	38.1 mm (1.50 in)	199-6152
21 mm	38.1 mm (1.50 in)	6V-9115
22 mm	38.1 mm (1.50 in)	6V-9116
23 mm	38.1 mm (1.50 in)	199-6153
24 mm	38.8 mm (1.53 in)	199-6154
25 mm	38.8 mm (1.53 in)	194-3558
26 mm	41.2 mm (1.62 in)	194-3559
27 mm	42.8 mm (1.69 in)	194-3562
28 mm	44.4 mm (1.75 in)	194-3563
29 mm	44.4 mm (1.75 in)	194-3564
30 mm	44.4 mm (1.75 in)	194-3565
31 mm	47.6 mm (1.87 in)	194-3566
32 mm	47.6 mm (1.87 in)	194-3567
1/2 inch Drive, Deep Length Sockets, 12 Point		
16 mm	82.6 mm (3.25 in)	194-3505
17 mm	82.6 mm (3.25 in)	194-3506
18 mm	82.6 mm (3.25 in)	194-3510
19 mm	82.6 mm (3.25 in)	194-3511
20 mm	82.6 mm (3.25 in)	194-3512
21 mm	82.6 mm (3.25 in)	194-3513
22 mm	82.6 mm (3.25 in)	194-3514
24 mm	82.6 mm (3.25 in)	194-3515
25 mm	82.6 mm (3.25 in)	194-3516
26 mm	82.6 mm (3.25 in)	194-3517
33 mm	76.2 mm (3 in)	386-3338
1/2 inch Drive, Standard Length Impact Sockets, 6 Point, Black		
10 mm	38.1 mm (1.50 in)	213-6926
11 mm	38.1 mm (1.50 in)	213-6927
12 mm	38.1 mm (1.50 in)	213-6928
13 mm	38.1 mm (1.50 in)	213-6929

Ratchets and Sockets — Individual Sockets

Individual Metric Sockets, 1/2 in Drive (Cont'd.)

Size	Length	Part Number
14 mm	38.1 mm (1.50 in)	213-6930
15 mm	38.1 mm (1.50 in)	213-6932
16 mm	38.1 mm (1.50 in)	213-6933
17 mm	38.1 mm (1.50 in)	213-6934
18 mm	38.1 mm (1.50 in)	213-6935
19 mm	38.1 mm (1.50 in)	213-6936
20 mm	38.1 mm (1.50 in)	213-6924
21 mm	38.1 mm (1.50 in)	213-6937
1/2 inch Drive, Deep Length Impact Sockets, 6 Point, Black		
10 mm	82.6 mm (3.25 in)	214-6644
11 mm	82.6 mm (3.25 in)	214-6645
12 mm	82.6 mm (3.25 in)	214-6646
13 mm	82.6 mm (3.25 in)	214-6647
14 mm	82.6 mm (3.25 in)	214-6648
15 mm	82.6 mm (3.25 in)	214-6649
16 mm	82.6 mm (3.25 in)	214-6650
17 mm	82.6 mm (3.25 in)	214-6651
18 mm	82.6 mm (3.25 in)	214-6652
19 mm	82.6 mm (3.25 in)	214-6653
20 mm	82.6 mm (3.25 in)	214-7346
33 mm	76.2 mm (3 in)	386-3337

Individual Metric Sockets, 3/4 in Drive

Warranty: Lifetime unless otherwise noted

Size	Length	Part Number
3/4 inch Drive, Standard Length Sockets, 6 Point		
24 mm	50.8 mm (2 in)	6V-9117
30 mm	57.2 mm (2.25 in)	6V-9118
36 mm	58.7 mm (2.31 in)	6V-9119
46 mm	73 mm (2.87 in)	6V-9120
32 mm	48 mm (1.89 in)	386-3358

Ratchets and Sockets — Individual Sockets

Individual Metric Sockets, 3/4 in Drive (Cont'd.)

Size	Length	Part Number
3/4 inch Drive, Standard Length Impact Sockets, 12 Point		
20 mm	55.5 mm (2.19 in)	152-1058
3/4 inch Drive, Deep Length Impact Sockets, 6 Point		
36 mm	89 mm (3.50 in)	175-6797
43 mm	88.9 mm (3.50 in)	6V-7874
3/4 inch Drive, Standard Length Impact Sockets, 6 Point, Black		
17 mm	44.5 mm (1.75 in)	9U-6523
19 mm	44.5 mm (1.75 in)	9U-6524
20 mm	44.5 mm (1.75 in)	9U-6525
21 mm	47.8 mm (1.88 in)	9U-6526
22 mm	47.6 mm (1.87 in)	9U-6527
23 mm	47.8 mm (1.88 in)	9U-6528
24 mm	47.6 mm (1.87 in)	9U-6529
26 mm	50.8 mm (2 in)	9U-6530
27 mm	50.8 mm (2 in)	9U-6531
28 mm	53.8 mm (2.12 in)	9U-6532
30 mm	53.8 mm (2.12 in)	9U-6533
31 mm	54 mm (2.13 in)	9U-6534
32 mm	54 mm (2.13 in)	9U-6535
33 mm	53.8 mm (2.12 in)	9U-6536
34 mm	54 mm (2.13 in)	9U-6537
35 mm	57.2 mm (2.25 in)	9U-6538
36 mm	57.2 mm (2.25 in)	9U-6539
38 mm	57.2 mm (2.25 in)	9U-6540
40 mm	66.7 mm (2.63 in)	9U-6541
41 mm	66.5 mm (2.62 in)	9U-6542
42 mm	66.5 mm (2.62 in)	9U-6543
43 mm	66.5 mm (2.62 in)	9U-6544
46 mm	66.7 mm (2.63 in)	9U-6545
50 mm	73.2 mm (2.88 in)	9U-6546

Individual Metric Sockets, 1 in through 2 1/2 in Drive (also No. 5 Spline)

Warranty: Lifetime unless otherwise noted

Size	Length	Part Number
1 inch Drive, Standard Length Impact Sockets, 6 Point		
30 mm	54 mm (2.13 in)	386-3261
36 mm	63.5 mm (2.50 in)	9U-5089

Ratchets and Sockets — Individual Sockets

Individual Metric Sockets, 1 in through 2 1/2 in Drive (also No. 5 Spline) (Cont'd.)

Size	Length	Part Number
46 mm	60 mm (2.38 in)	386-3262
46 mm	73.5 mm (2.9 in)	4C-6724
46 mm	86 mm (3.39 in)	207-8155
1 inch Drive, Deep Length Impact Sockets, 6 Point		
55 mm	111 mm (4.37 in)	4C-8217
1 inch Drive, Standard Length Impact Sockets, 12 Point		
55 mm	83 mm (3.27 in)	386-3318
41 mm	70 mm (2.76 in)	386-3310
60 mm	83 mm (3.27 in)	386-3311
95 mm	100 mm (3.94 in)	386-3312
33 mm	61 mm (2.40 in)	386-3314
36 mm	65 mm (2.56 in)	386-3315
46 mm	75 mm (2.95 in)	386-3316
50 mm	80 mm (3.15 in)	386-3317
65 mm	86 mm (3.39 in)	386-3319
70 mm	86 mm (3.39 in)	386-3320
75 mm	86 mm (3.39 in)	386-3321
80 mm	90 mm (3.54 in)	386-3322
88 mm	90 mm (3.54 in)	386-3323
1 inch Drive, Tapered Impact Sockets, 6 Point⁽¹⁸⁾		
19 mm	89 mm (3.50 in)	1U-7626
22 mm	89 mm (3.50 in)	1U-7627
24 mm	89 mm (3.50 in)	1U-7628
27 mm	89 mm (3.50 in)	1U-7629
30 mm	89 mm (3.50 in)	1U-7630
32 mm	89 mm (3.50 in)	1U-7631
1 1/2 inch Drive, Standard Length Impact Sockets, 6 Point		
55 mm	90.4 mm (3.56 in)	136-5189
65 mm	102.4 mm (4.03 in)	132-8743
70 mm	107.1 mm (4.22 in)	136-5190

¹⁸ Special design for excavator track bolts; not intended for general use

Ratchets and Sockets — Individual Sockets

Individual Metric Sockets, 1 in through 2 1/2 in Drive (also No. 5 Spline) (Cont'd.)

Size	Length	Part Number
46 mm	83 mm (3.27 in)	386-3252
1 1/2 inch Drive, Standard Length Impact Sockets, 12 Point		
36 mm	84 mm (3.31 in)	386-3306
50 mm	87 mm (3.43 in)	386-3307
60 mm	95 mm (3.74 in)	386-3308
75 mm	110 mm (4.33 in)	386-3309
2 1/2 inch Drive, Impact Sockets 12 Point		
95 mm	140 mm (5.51 in)	386-3313
No. 5 Spline, Standard Length Impact Socket, 6 Point		
55 mm	94.5 mm (3.72 in)	159-2833

Ratchets and Sockets — Special Application Sockets

Fractional Hex Driver Set, 10 Piece - 214-6142



Warranty: See individual part number

- Seven 3/8 inch drive hex sockets and three 1/2 inch drive hex sockets
- Includes socket bar and clips
- Can be ordered by set or individually

Part Number	Description	Hex Size	Square Drive	Overall Length	Replacement Bit
214-6142	Hex Driver Set	—	—	—	—
Hex Driver Set Consists of:					
214-7320	Drive Hex Socket	1/2 in	1/2 in	53.18 (2.09 in)	214-7321
214-7327	Drive Hex Socket	9/16 in	1/2 in	53.18 (2.09 in)	1P-3566
214-7328	Drive Hex Socket	5/8 in	1/2 in	53.18 (2.09 in)	214-7331
2P-8263	Drive Hex Socket	1/8 in	3/8 in	52.39 (2.06 in)	2P-8269
2P-8264	Socket	5/32 in	3/8 in	52.39 (2.06 in)	2P-8271
2P-8265	Socket	3/16 in	3/8 in	52.39 (2.06 in)	2P-8272
2P-8266	Drive Hex Socket	1/4 in	3/8 in	52.39 (2.06 in)	2P-8273
2P-8267	Drive Hex Socket	5/16 in	3/8 in	52.39 (2.06 in)	—
2P-8268	Drive Hex Socket	3/8 in	3/8 in	53.18 (2.09 in)	2P-8275
8T-3042	Drive Hex Socket	7/32 in	3/8 in	52.39 (2.06 in)	8T-3043
Individual Socket and Hex Bit					
5P-7253	Socket and Hex Bit	9/64 in	3/8 in	—	—

Fractional Hex Ball Driver Socket Set, 8 Piece - 246-8499



Warranty: Lifetime

- Four 1/4 inch drive hex ball sockets and four 3/8 inch drive hex ball sockets
- Material: steel
- Includes socket bar and clips
- Can be ordered by set or individually

Part Number	Description	Hex Size	Square Drive	Overall Length
246-8499	Hex Ball Driver Socket Set	—	—	—
Hex Ball Driver Socket Set Consists of:				
243-5173	Socket	5/16 in	3/8 in	53.18 mm (2 3/32 in)
243-5174	Socket	3/8 in	3/8 in	53.18 mm (2 3/32 in)
243-5175	Socket	7/32 in	3/8 in	52.39 mm (2 1/16 in)
243-5177	Socket	1/4 in	3/8 in	52.39 mm (2 1/16 in)
243-5178	Socket	1/8 in	1/4 in	47.63 mm (1 7/8 in)
243-5179	Socket	9/64 in	1/4 in	47.63 mm (1 7/8 in)
243-5180	Socket	5/32 in	1/4 in	47.63 mm (1 7/8 in)
243-5181	Socket	3/16 in	1/4 in	49.21 mm (1 15/16 in)

Ratchets and Sockets — Special Application Sockets

Metric Hex Driver Set, 9 Piece - 194-3585



Warranty: See individual part number

- Includes socket bar and clips
- Can be ordered by set or individually

Part Number	Description	Hex Size	Drive	Bit Length	Overall Length	Replacement Bit
194-3585	Hex Bit Socket Set ⁽¹⁾	—	—	—	—	—
Set Consists of:						
194-3541	Metric Hex Driver	4.0 mm	3/8 in	25.4 mm	52.3 mm (2.06 in)	—
194-3542	Hex Socket Bit Driver	5.0 mm	3/8 in	25.7 mm	52.6 mm (2.07 in)	—
194-3544	Metric Hex Driver	7.0 mm	3/8 in	25.7 mm	52.6 mm (2.07 in)	—
194-3545	Metric Hex Driver	8.0 mm	3/8 in	25.1 mm	52.1 mm (2.05 in)	—
194-3546	Metric Hex Driver	10.0 mm	3/8 in	25.5 mm	52.5 mm (2.07 in)	—
194-3547	Metric Hex Driver	12.0 mm	1/2 in	—	81 mm (3.19 in)	—
194-3548	Metric Hex Driver	14.0 mm	1/2 in	—	81 mm (3.19 in)	—
194-3549	Metric Hex Driver	17.0 mm	1/2 in	—	93.7 mm (3.69 in)	—
Optional Metric Hex Drivers						
129-4552	Metric Hex Driver	27.0 mm	1 in	72.0 mm	129 mm (5.08 in)	129-4553
140-8780 ⁽²⁾	Metric Hex Driver ⁽³⁾	24.0 mm	—	50.8 mm	50.8 mm (2 in)	—
168-8395	Drive Impact Socket	17.0 mm	3/4 in	50.8 mm	61.7 mm (2.43 in)	169-0782
194-3543	Metric Hex Driver	6.0 mm	3/8 in	25.7 mm	52.6 mm (2.07 in)	—
1U-6151	Metric Hex Driver	17.0 mm	3/4 in	47.0 mm	92 mm (3.62 in)	1U-6152
1U-9474	Metric Hex Driver ⁽³⁾	22.0 mm	1 in	32.0 mm	84 mm (3.31 in)	1U-9476
6V-9086	Metric Hex Driver ⁽³⁾	14.0 mm	1/2 in	35.0 mm	81 mm (3.19 in)	—
9U-7418	Metric Hex Driver	19.0 mm	3/4 in	47.7 mm	111.3 mm (4.38 in)	1U-7419

1 Warranty: Lifetime
 2 Hex bit only
 3 Warranty: 6 Months

Ratchets and Sockets — Special Application Sockets

Metric Hex Ball Driver Socket Set, 8 Piece - 243-5182



Warranty: Lifetime

- Four 1/4 inch drive hex ball sockets and four 3/8 inch drive hex ball sockets
- Material: steel
- Includes socket bar and clips
- Can be ordered by set or individually

Hex Size	Part Number	Description	Drive	Bit Length	Overall Length
—	243-5182	Complete Hex Ball Driver Socket Set	—	—	—
Set Consists of:					
3.0 mm	243-5190	Hex Ball Driver	1/4 in	—	47.7 mm (1.88 in)
4.0 mm	243-5184	Hex Ball Driver	1/4 in	—	47.6 mm (1.87 in)
5.0 mm	243-5185	Hex Ball Driver	1/4 in	—	47.9 mm (1.89 in)
6.0 mm	243-5186	Hex Ball Driver	1/4 in	—	47.9 mm (1.89 in)
7.0 mm	243-5187	Hex Ball Driver	3/8 in	25.6 mm	52.5 mm (2.07 in)
8.0 mm	243-5188	Hex Ball Driver	3/8 in	25.6 mm	52.5 mm (2.07 in)
9.0 mm	243-5189	Hex Ball Driver	3/8 in	25.6 mm	52.5 mm (2.07 in)
10.0 mm	243-5183	Hex Ball Driver	3/8 in	25.6 mm	52.5 mm (2.07 in)
Optional Metric Hex Ball Drivers					
4.0 mm	4C-8996	Hex Ball Driver	3/8 in	—	128.3 mm (5.05 in)
10.0 mm	155-3046	Hex Ball Driver	3/8 in	—	128.3 mm (5.05 in)

Individual Fractional Hex Driver Sockets

Part Number	Hex Size	Square Drive	Overall Length
386-3344	9/32"	3/8"	110 mm (4 1/3 in)
386-3336	3/4"	1/2"	114.3 mm (4 1/2 in)
386-3341	3/4"	3/4"	88.9 mm (3 1/2 in)
386-3342	5/8"	3/4"	88.9 mm (3 1/2 in)
386-3343	7/8"	3/4"	88.9 mm (3 1/2 in)

Drivers for TORX Screws



Warranty: Lifetime

Part Number	Description	Size	Use
5P-3038	Socket Assembly	3/8 in square drive	Removal of shaft seal and bearing retainer fasteners TORX T-30 on 16G Motor Grader circle drive motor
6V-2123	Socket Assembly	3/8 in square drive	Removal of TORX T-55 screws which retain brake cylinders to support plates on "V" Series Lift Trucks

Ratchets and Sockets — Special Application Sockets

TORX Driver Set, 10 Piece - 194-3584



Warranty: Lifetime

- Ten pieces, 1/4 inch and 3/8 inch square drive
- TORXALIGN® design grips TORX fasteners for easier fastener starting (TORX and TORXALIGN are registered trademarks of Camcar, Inc.)
- Includes socket bar and clips
- Can be ordered by set or individually

Torx Size	Part Number	Description	Square Drive	Overall Length
Complete Driver Set				
–	194-3584	Torx Socket Set	–	–
TORXALIGN Bits				
T10	194-3531	Socket, Assembly, T10	1/4 in	39.6 mm (1.56 in)
T15	194-3532	Socket, Assembly, T15	1/4 in	39.6 mm (1.56 in)
T20	194-3533	Socket, Assembly, T20	1/4 in	39.6 mm (1.56 in)
T25	194-3534	Socket, Assembly, T25	1/4 in	39.6 mm (1.56 in)
T30	194-3535	Socket, Assembly, T30	3/8 in	44.5 mm (1.75 in)
T40	194-3536	Socket, Assembly, T40	3/8 in	44.5 mm (1.75 in)
T45	194-3537	Socket, Assembly, T45	3/8 in	52.3 mm (2.06 in)
T50	194-3538	Socket, Assembly, T50	3/8 in	52.3 mm (2.06 in)
T55	194-3539	Socket, Assembly, T55	3/8 in	51.6 mm (2.03 in)
One Piece, 1/4 inch Square Drive TORX Socket included				
E8	194-3540	Square Drive TORX Socket	1/4 in	22.2 mm (0.87 in)

Inverted TORX Socket Set, 10 Piece - 227-4383



Warranty: Lifetime

- TORX sockets for fuel system maintenance and repair
- Ten piece set, 1/4 inch and 3/8 inch square drive
- Socket teeth provide maximum engagement and increased gripping ability
- Each socket can be ordered separately
- Sockets should not be used with power drivers (air wrenches, etc.)
- Chrome plating prevents corrosion and cleans easily
- Includes socket rail and clips to keep sockets neatly organized
- Can be ordered by set or individually

Torx Size	Square Drive	Part Number	Overall Length
Complete Socket Set			
–	–	227-4383	–
Set Consists of:			
E4	1/4 in	227-4384	22 mm (0.87 in)
E5	1/4 in	227-4385	22 mm (0.87 in)

Ratchets and Sockets — Special Application Sockets

Inverted TORX Socket Set, 10 Piece - 227-4383 (Cont'd.)

Torx Size	Square Drive	Part Number	Overall Length
E6	1/4 in	227-4386	22 mm (0.87 in)
E7	1/4 in	227-4387	22 mm (0.87 in)
E8	1/4 in	227-4388	22 mm (0.87 in)
E10	3/8 in	227-4389	30 mm (1.18 in)
E12	3/8 in	227-4390	30 mm (1.18 in)
E14	3/8 in	227-4391	30 mm (1.18 in)
E16	3/8 in	227-4392	32 mm (1.26 in)
E18	3/8 in	227-4393	33 mm (1.30 in)

Pin Socket - 5P-5249



Warranty: Lifetime

- Used with 3/8 inch drive speeder handle to remove and install buttons that hold ROPS Cab headliner in position for air conditioning repairs
- Use 3F-4479 Spring Pins as replacements if spring pins (1) become worn or damaged

Part Number	Description
5P-5249	Pin Socket

Hex Socket, 55 mm (Spline Drive) - 159-2833



Model: 797 Off-Highway Trucks

Warranty: Lifetime

- Used to remove and install tires and rims using M36 bolts with 55 mm hex head
- Used with 4C-9813 Extension, 6V-6080 Torque Multiplier, 8T-5230 Air Regulated Wrench, and 4C-9814 Reaction Bar
- Black industrial finish
- High-strength, impact socket

Part Number	Hex Size	Drive	Overall Length	Diameter
159-2833	55 mm (2 3/16 in), 12 point	#5 spline	94.5 mm (3.72 in)	78.6 mm (3.09 in)

Ratchets and Sockets — Special Application Sockets

Stacking Sockets (Metric)



Models: 777, 785, 789, 793, 797 Off-Highway Trucks
 Warranty: Caterpillar Standard Warranty, 6 Months

- Used to tighten brake anchor nuts
- Used with hydraulic wrench systems
- Allows access to limited clearance areas
- Ensures accurately tightened anchor nuts

Part Number	Description	Size
203-5431	Stacking Socket	female 1 5/16, male 36 mm
203-5432	Stacking Socket	female 1 1/2, male 36 mm
203-5433	Stacking Socket	female 36 mm, male 36 mm
203-5434	Stacking Socket	female 46 mm, male 46 mm
203-5435	Stacking Socket	female 55 mm, male 46 mm

Special Large Socket Wrenches



Warranty: Caterpillar Standard Warranty, 6 Months

Part Number	Description	Hex Size	Usable Depth
3/4 inch Drive			
1B-4657	Large Socket Wrench	2.75 in	4.50 in
1U-6689	Large Socket Wrench	3.50 in	6.30 in
1U-6691	Large Socket Wrench	5.50 in	7.90 in
1U-6692	Large Socket Wrench	5.75 in	7.90 in
2B-1730	Large Socket Wrench	3.39 in	4.50 in
2B-1731	Large Socket Wrench	3.63 in	4.50 in
3B-6352	Large Socket Wrench	2.63 in	4.50 in
5P-3540	Large Socket Wrench	3.50 in	4.50 in
7M-7809	Large Socket Wrench	2.88 in	7.25 in
Bar Turn			
9F-9963	Bar Turn	1.46 in	8.38 in

Lock Removal Socket



Warranty: Lifetime

- 1/2 inch drive

Part Number	Size
5P-6587	1/2 in Hex
5P-6588	9/16 in Hex
5P-6589	3/4 in Hex

Ratchets and Sockets — Special Application Sockets

Spark Plug Sockets



SMCS Code: 1555-010

Model: G3516B (50 Hz), G3516B (60 Hz), G3520B (50 Hz), and G3500C

Warranty: Caterpillar Standard Warranty: 6 Months

- Thin wall design eliminates possible socket interference

Part Number	Description	Size	Length	Application
216-1685	Spark Plug Socket	1/2 in drive, 13/16 in, 6 point hex	103 mm overall length	—
4C-4601	Spark Plug Socket	7/8 inch hex, 1/2 inch square drive, 6 point	103.1 mm (4.06 in) long	Special thin wall for use on G3500 and G3600 Engines

Ratchets and Sockets — Extensions/Adapters

Universal Joint Extension Socket



Warranty: Caterpillar Standard Warranty, 6 Months

- 1/2 inch drive
- 12 point

Part Number	Size	Length
6V-4058	5/8 in	182.6 mm (7.19 in)

Socket Extensions

Warranty: Lifetime



Part Number	Drive	Length
9S-1720	1/4 in	50.8 mm (2 in)
9S-1721	1/4 in	101.6 mm (4 in)
8H-8574	3/8 in	76.2 mm (3 in)
8H-8575	3/8 in	152.4 mm (6 in)
3P-2240	3/8 in	304.8 mm (12 in)
271-4722 ⁽¹⁾	1/2 in	76.2 mm (3 in)
5P-8676	1/2 in	76.2 mm (3 in)
9S-1732	1/2 in	127.0 mm (5 in)
271-4723 ⁽¹⁾	1/2 in	127.0 mm (5 in)
8H-8559	1/2 in	279.0 mm (10.98 in)

Part Number	Drive	Length
271-4724 ⁽¹⁾	1/2 in	279.0 mm (10.98 in)
386-3271	3/4 in	76.2 mm (3 in)
8H-8548	3/4 in	203.2 mm (8 in)
8T-9265 ⁽²⁾	3/4 in	254.0 mm (10 in)
8T-5183 ⁽²⁾	3/4 in	406.4 mm (16 in)
386-3260	1 in	76.2 mm (3 in)
5S-6076	1 in	203.2 mm (8 in)
158-8723 ⁽³⁾	1 in ⁽⁴⁾	476.0 mm (18.74 in)
386-3253	1 1/2 in	203.2 mm (8 in)

Universal Drives



Warranty: Lifetime

- Used with Cat torque multipliers as well as other applications

5P-1749

- Use with the 5S-6076 Extension, 5P-1748 Socket, and a suitable torque multiplier to loosen and tighten the nuts which retain 8D and 9D Ripper mounting brackets

5P-3534

- Use with a Torque Multiplier in applications such as tightening the nuts which secure the final drive housings to the rear frame and case of Cat Articulated Motor Graders

- 1 Impact
- 2 Requires locking pin
- 3 Double hole extension
- 4 Warranty: Six Months

Ratchets and Sockets — Extensions/Adapters

Universal Drives (Cont'd.)

Drive	Part Number	Torque Capacity	Angular Rotation
3/4 in	5P-3534	1,000 ft lb	30 Degrees
1 in	5P-1749	1,500 ft lb	30 Degrees

Ratchet Adapter - 1P-0853



Warranty: Manufacturer, Lifetime

- 3/4 inch female to 3/4 inch male
- Used primarily with the 1P-0850 Torque Multiplier
- Convenient for other applications such as with the 3/4 inch drive 9S-7351 Torque Wrench

Part Number	Capacity
1P-0853	450 lb

Hex Shank - 4C-9818



Warranty: Lifetime

Part Number	O.A.L.	Size
4C-9818	2 3/4 in	7/16 in HEX x 1 1/4 in on one end with 1/2 in square drive (male) with lock button on other end

Universal Joint - 4C-9819



Warranty: Manufacturer

Part Number	O.D.	O.A.L.	Size
4C-9819	1 3/18 in	2 1/2 in	1/2 in square drive (female) with lock button hole

Ratchets and Sockets — Extensions/Adapters

Socket Drive Adapters

Warranty: Lifetime



Part Number	Description	Size	Replacement Bit
213-4437	Socket Adapter	1/4 in Female to 3/8 in male	—
261-0443	Socket Adapter	3/8 in Female to 1/4 in male	261-0446
452-0539	Socket Adapter	1/2 in Female to 3/8 in Male	—
452-0541	Socket Adapter	3/4 in Female to 1/2 in Male	452-0542
261-8569	Socket Adapter	1 in Female to 1 1/2 in Male	—
261-8570	Socket Adapter	1 1/2 in Female to 1 in Male	—
2P-8261	Adapter	3/4 in Female to 1 in Male	—
5P-3588	Socket Adapter	1 in Female to 3/4 in Male	—
8H-8561	Adapter	1/2 in Female to 3/4 in Male	—
8H-8576	Adapter	3/8 in Female to 1/2 in Male	—

Impact Wrench Socket Adapters

Warranty: See individual part



- Heavy-duty adapter and extensions can be used with 1 1/2 inch drive impact wrenches
- Allows the use of 1 inch drive sockets instead of the higher priced 1 1/2 inch drive sockets

Item	Part Number	Description
1	9S-4028	Extension, 1 in drive both ends, 133.4 mm (5.25 in) long ⁽⁵⁾
2	9S-4026	Adapter, 1 1/2 in to 1 in drive ⁽⁵⁾
3	9S-4027	Extension, 1 in drive both ends, 60.3 mm (2.38 in) long ⁽⁵⁾
Not shown	207-8160	Extension, 1 in drive, 76.2 mm (3 in) long ⁽⁶⁾

Universal Joint

Warranty: Lifetime



Drive	Part Number
1/4 in	9S-1724
3/8 in	6V-0094
1/2 in	8H-8560

⁵ Warranty: Manufacturer, 30 Day

⁶ Warranty: Lifetime

Cordless Power Tools

463-6821 Cordless Impact Wrench Kit (18v)



Warranty: Manufacturer, Lifetime

Cordless Impact Wrench, Two 18v Lithium Battery Packs, Charger with USB Port, Six Cat Impact Sockets, Cat Storage Bag

- 600 ft lb (813 Nm) of torque output with 750 ft lb (1,017 Nm) of bolt breakaway torque
- 1,900 RPM free speed with 2,280 blows per minute
- Soft-start trigger
- Uses a sintered rare earth magnet motor to deliver more torque with less battery drain
- Built-in brake stops anvil to prevent thrown fasteners or sockets
- Integrated LED covers work area in super bright light
- Digital microprocessor controlled switch maximizes performance, runtime, and durability
- Integrated battery management prevents battery drain and prolongs tool life
- Charge time 60 minutes/5 amp
- USB port built into charger
- Cat 1/2-inch impact sockets: 13, 19 mm and 1/2, 9/16, 3/4, 7/8 in
- Cat branded bag
- Length 9.2 in (234 mm), height 7.7 in (196 mm)
- Weight 7.3 lb (3.3 kg)
- UL, CUL, CE marked

Cordless Drill Kit (18v) - 151-0968



Warranty: Manufacturer's

Cordless Driver/Drill, 18v Ni-Cad Battery Pack, Charger, Storage Bag

- Industrial strength gear train and heat treated alloy gears for durability and long life
- Patented air flow system cools the motor
- Single sleeve keyless chuck for one handed bit changes
- 22-position clutch makes dialing in the right torque easy
- UL, CUL, CE marked

Part Number	Description
151-0968	Cordless Drill Kit (18v)

Heavy-Duty Angle Grinder, 11,000 RPM, 4.5 inch - 288-2512

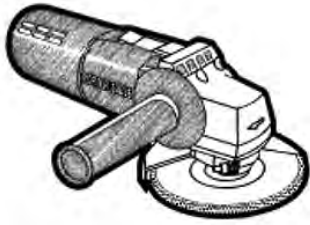

Warranty: Lifetime

- Turns at 11,000 RPM for maximum grinding performance and efficiency
- Vibration-control side handle reduces vibration up to 60%, providing uncompromising comfort for extended periods of work
- AC/DC capability extends the versatility of the tool by working from DC outlets such as welders and generators
- Sealed switch keeps debris out of the switch mechanism and extends switch life
- Service Minder brushes eliminate guesswork, stop the tool when preventative maintenance is required
- Epoxy-coated field windings provide ultimate protection against abrasive dust and metal debris
- 5/8 inch - 11 spindle for mounting most popular accessories
- Tool-free adjustable guard for quick guard installation and adjustments
- Spindle lock for quick wheel changes
- 2-position auxiliary handle specifically designed and angled to a "natural" position for maximum comfort and control
- Double insulated, UL listed, OSHA compliant

Part Number	Power	Motor Amps	No Load Speed (RPM)	Spindle Thread Size	Wheel Size	Length	Net Weight
288-2512	120V AC/DC	7.5	11,000	5/8 in - 11	114.3 mm (4 1/2 in)	285.75 mm (11 1/4 in)	1.95 mm (4.3 lb)

Pneumatic Tools — Impact Wrenches

Composite Pneumatic Impact Wrenches



Warranty: Caterpillar, 18 months

- Composite housing for lighter weight
- 18-month warranty
- Easy to rebuild with the anvil repair kit and the motor/throttle repair kit
- CE marked

3/8 inch	266-3737
1/2 inch	266-3736

Specifications for 266-3737 3/8 in Composite Impact Wrench

Drive Size	3/8 inch
Recommended Air Pressure	90 psig (620 kPa)
Air Consumption, Free Speed	3.3 cfm (23 scfm) (93.45 l/min)
Air Consumption, Working	2.2 cfm (16 scfm) (62.3 l/min)
Free Speed, Forward	9000 rpm
Free Speed, Reverse	9500 rpm
Sound Level, Working	107.3 dBa
Blows Per Minute	1420
Maximum Torque	250 ft lb (339 Nm)
Air Inlet Thread Size	¼ in – 18 NPT
Overall Length	6.6 in (168 mm)
Weight	3.0 lb (1.36 kg)

Serviceable Parts for 266-3737 3/8 in Composite Impact Wrench

Anvil Part Number	280-2675
Motor and Throttle Repair Kit	280-2676
Anvil Repair Kit	280-2677

Specifications for 266-3736 1/2 in Composite Impact Wrench

Drive Size	1/2 inch
Recommended Air Pressure	90 psig (620 kPa)
Air Consumption, Free Speed	3.6 cfm (26 scfm) (101.9 l/min)
Air Consumption, Working	2.6 cfm (16 scfm) (73.6 l/min)
Free Speed, Forward	7000 rpm
Free Speed, Reverse	8000 rpm
Sound Level, Working	107.2 dBa
Blows Per Minute	1140
Maximum Torque (forward)	550 ft lb (746 Nm)
Maximum Torque (reverse)	600 ft lb (813 Nm)
Air Inlet Thread Size	¼ in – 18 NPT
Overall Length	7.6 in (192 mm)
Weight	4.3 lb (1.95 kg)

Pneumatic Tools — Impact Wrenches

Composite Pneumatic Impact Wrenches (Cont'd.)

Serviceable Parts for 266-3736 1/2 in Composite Impact Wrench	
Anvil Part Number	280-2678
Motor and Throttle Repair Kit	280-2679
Anvil Repair Kit	280-2680

Impact Wrenches, 3/8 inch



Warranty: Manufacturer, 18 Month

European Union Compliant, CE marked

- Reverse bias air motor provides greater power in reverse for extra break away torque
- Molded ergonomic handle grip reduces vibration and operator fatigue
- Built in power regulator allows power output to be adjusted to operating conditions

Repair Information

The Tool Repair Center can help with questions about repair options, calibration details, or general customer service needs.

Call +1(262) 656-4769 worldwide or in North America, toll-free at (855) 351-0926 or send an email to catwarranty@snapon.com.

Drive size	3/8 in
Recommended air pressure	620 kPa (90 PSIG)
Air consumption, free speed	14 SCFM (1.9 CFM) [53.8 l/min.]
Air consumption, working	25 SCFM (3.5 CFM) [99.11 l/min.]
Free speed, forward	8000 RPM
Free speed, reverse	9000 RPM
Sound level, free speed	84.6 dBa
Sound level, working	95.6 dBa
Blows per minute	1170
Maximum Torque	251- N·m (185 ft-lb) Forward / 285 N·m (210 ft-lb) Reverse
Air inlet thread size	1/4 in - 18 NPT
Recommended hose size, ID min.	10 mm (3/8 in)
Overall length	159 mm (6.25 in)
Height	179 mm (7 in)
Width	57 mm (2.24 in)
Weight	1.70 kg (3.75 lbs)

Part Number	Description	Anvil Part Number
222-3048	Impact Wrench, 3/8 inch	280-2681

Pneumatic Tools — Impact Wrenches

Impact Wrenches, 1/2 and 3/4 inch



European Union Compliant, CE marked

- Aluminum housing reduces weight and provides durable long life
- Steel nose front for extra protection, easy service access
- Power speed regulator allows power output to be adjusted to operating conditions
- Variable speed trigger allows operator versatility over wide range of fasteners

Repair Information

The Tool Repair Center can help with questions about repair options, calibration details, or general customer service needs.

Call +1(262) 656-4769 worldwide or in North America, toll-free at (855) 351-0926 or send an email to catwarranty@snapon.com.

Part No.	222-3050	222-3053
Drive Size	1/2 in	3/4 in
Recommended air pressure	620 kPa (90 PSIG)	620 kPa (90 PSIG)
Air consumption, free speed	30 SCFM (4.2 CFM) [118.9 l/min.]	41 SCFM (5.8 CFM) [164.2 l/min.]
Free speed forward	8000 RPM	4500 RPM
Free speed reverse	8000 RPM	5000 RPM
Sound level free speed	108 dBa	92 dBa
Maximum torque	578 N·m (425 ft-lb) forward	1626 N·m (1200 ft-lb)
Air inlet thread size	1/4 in - 18 NPT	3/8 in - 18 NPT
Recommended hose size, ID min.	8 mm (5/16 in)	10 mm (3/8 in)
Overall length	185 mm (7.3 in)	259 mm (10.2 in)
Weight	2.63 kg (5.8 lbs)	6.59 kg (14.5 lbs)

Part Number	Description	Anvil Part Number
222-3050	Impact Wrench, 1/2 in	280-2682
222-3053	Impact Wrench, 3/4 in	280-2683

Pneumatic Tools — Impact Wrenches

Impact Wrenches, 1 inch



Warranty: manufacturer, 18 Month

European Union Compliant, CE marked

- Power speed regulator allows power output to be adjusted to operating conditions
- Variable speed trigger allows operator versatility over wide range of fasteners

Repair Information

The Tool Repair Center can help with questions about repair options, calibration details, or general customer service needs.

Call +1(262) 656-4769 worldwide or in North America, toll-free at (855) 351-0926 or send an email to catwarranty@snapon.com.

Part No.	222-3054	222-3055
Drive size	1 in	1 in
Recommended air pressure	620 kPa (90 PSIG)	620 kPa (90 PSIG)
Air consumption free speed	60 SCFM (8.3 CFM) [235 l/min]	60 SCFM (8.3 CFM) [235 l/min]
Air consumption working	38 SCFM (5.3 CFM) [150.1 l/min]	38 SCFM (5.3 CFM) [150.1 l/min]
Free speed forward	4000 RPM	4000 RPM
Free speed reverse	4000 RPM	4000 RPM
Sound level free speed	92 dBa	92 dBa
Sound level working	103 dBa	103 dBa
Blows per minute	500	505
Maximum torque	3796 N·m (2800 ft-lb)	4067 N·m (3000 ft-lb)
Air inlet thread size	1/2 in - 14 NPT	1/2 in - 14 NPT
Recommended hose size, ID min.	13 mm (1/2 in)	13 mm (1/2 in)
Overall length	302 mm (11.8 in)	535 mm (21 in)
Height	270 mm (10.6 in)	172 mm (6.8 in)
Width	111 mm (4.37 in)	110 mm (4.33 in)
Weight	12.05 kg (26.5 lb)	12.27 kg (27 lb)

Part Number	Description	Anvil Part No.
222-3054	Impact Wrench, 1 in	280-2684
222-3055	Impact Wrench, 1 in	280-2684

Pneumatic Tools — Impact Wrenches

Impact Wrenches Repair Kits

Warranty: Lifetime unless otherwise noted

- Used to repair current Cat branded air-powered impact wrenches
- Reduce air tool repair cost by performing in-house repairs
- Reduced downtime (no need to ship air tool to a repair center)

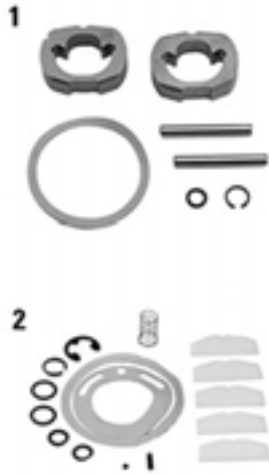

Typical Anvil Repair Kit Components - 231-6064	
Anvil repair kit for 12.7 mm (1/2 in) Impact Wrench	
Kit Includes:	
2-Hammers	2-Hammer Pins
1-Hammer Case Gasket	1-Retainer O-Rings
1-Socket Retainer	Material: Steel, Rubber, and Plastic
Motor and Throttle Repair Kit - 231-6063, for 12.7 mm (1/2 in) Impact Wrench	
Kit Includes:	
1-Detent Ball	1-Detent Spring
1-Gasket	1-Hammer Case Gasket
1-Retainer O-Ring	Material: Steel, Rubber, and Plastic

Item	Part Number	Description	Impact Wrench Part Number	Anvil Part Number
Impact Wrench Repair Kits				
–	231-6041	3/8 inch Motor and Throttle Repair Kit	222-3048	–
–	231-6043	3/8 inch Anvil Repair Kit	222-3048	280-2681
–	231-6068	3/4 inch Motor and Throttle Repair Kit	222-3053	–
–	231-6070	3/4 inch Anvil Repair Kit	222-3053	280-2683
–	231-6071	1 inch Anvil Repair Kit	222-3054	280-2684
–	231-6073	1 inch Motor and Throttle Repair Kit	222-3054	–
–	231-6074	1 inch Anvil Repair Kit	222-3055	280-2684
–	231-6098	1 inch Motor and Throttle Repair Kit	222-3055	–
–	280-2676	3/8 inch Motor and Throttle Repair Kit ⁽¹⁾	266-3737	–
–	280-2677	3/8 inch Anvil Repair Kit ⁽¹⁾	266-3737 ⁽²⁾	280-2675
–	280-2679	1/2 inch Motor and Throttle Repair Kit ⁽¹⁾	266-3736 ⁽²⁾	–
–	280-2680	1/2 inch Anvil Repair Kit ⁽¹⁾	266-3736 ⁽²⁾	–
1	231-6064	1/2 inch Anvil Repair Kit	222-3050	280-2682
2	231-6063	1/2 inch Motor and Throttle Repair Kit	222-3050	–

1 Warranty: Six Months

2 Warranty: Manufacturer, 18 Month

Pneumatic Tools — Sanders and Polishers

Sanders and Polishers



Warranty: Manufacturer, 18 Month

European Union Compliant, CE marked

- Aluminum housing reduces weight and provides durable long life
- Compact design for easy maneuvering in restricted areas
- Ball bearing mounted air motor reduces vibration and operator fatigue; prolongs motor life
- Full choice of RPM ranges
- 5 inch and 7 inch HD angle, 2-handed vertical and in-line sanders
- 7 inch polisher

Repair Information

The Tool Repair Center can help with questions about repair options, calibration details, or general customer service needs.

Call +1(262) 656-4769 worldwide or in North America, toll-free at (855) 351-0926 or send an email to catwarranty@snapon.com.

Part Number	Recommended air pressure	Free Speed Air Consumption	Horse-power	Free Speed	Sound Level, Free Speed	Spindle Thread Size	Pad/Disc Size, Diameter	Backing Pad	Air Inlet Thread Size	Recommended Hose Size, ID min.	Overall Length	Height	Weight
Palm Sander, 6 in													
222-3063	620kPa (90 PSIG)	36 SCFM (5 CFM) [141.6 l/min.]	–	10000 RPM	83 dBa	5/16 in - 18 UNC	152 mm (6 in)	231-9464	1/4 in - 18 NPT	8 mm (5/16 in)	122 mm (4.8 in)	–	1.36 kg (3 lb)
7 in Angle Sander													
222-3064	620kPa (90 PSIG)	34 SCFM (4.8 CFM) [135.9 l/min.]	1	5100 RPM	84 dBa	5/8 in - 11 UNC	178 mm (7 in)	231-9465	1/4 in - 18 NPT	8 mm (5/16 in)	410 mm (15.75 in)	102 mm (4 in)	3.09 kg (6.8 lb)
7 in Vertical Sander													
222-3065	620kPa (90 PSIG)	31 SCFM (4.3 CFM) [121.8 l/min.]	–	4500 RPM	83 dBa	5/16 in - 11 UNC	178 mm (7 in)	231-9465	1/4 in - 18 NPT	10 mm (3/8 in)	–	190 mm (7.5 in)	2.72 kg (6 lb)
In-line Sander													
222-3067	620kPa (90 PSIG)	16 SCFM (2.3 CFM) [65.13 l/min.]	–	1800 osc/min	87 dBa	–	2 3/4 x 17 1/2	–	1/4 in - 18 NPT	8 mm (5/16 in)	406 mm (16 in)	121 mm (4.75 in)	–
6 in OASander													
222-3068	410kPa (60 PSIG) (1)	11 SCFM (2.1 CFM) [59.47 l/min.]	0.25	10000 RPM	93 dBa	5/16 in - 18 UNC	150 mm (6 in)	231-9468, 246-7509	1/4 in - 18 NPT	8 mm (5/16 in)	260 mm (10.2 in)	–	2.2 kg (4.9 lb)
5 in Compact Sander													
222-3084	620kPa (90 PSIG)	32 SCFM (4.2 CFM)	0.3	1400 RPM	88 dBa	7/16 in - 20 UNC	127 mm (5 in)	231-9469	1/4 in - 18 NPT	8 mm (5/16 in)	118 mm (4.6 in)	121 mm (4.75 in)	–

Pneumatic Tools — Sanders and Polishers

Sanders and Polishers (Cont'd.)

Part Number	Recommended air pressure	Free Speed Air Consumption	Horsepower	Free Speed	Sound Level, Free Speed	Spindle Thread Size	Pad/Disc Size, Diameter	Backing Pad	Air Inlet Thread Size	Recommended Hose Size, ID min.	Overall Length	Height	Weight
		[118.9 l/min.]											
7 in Angle Polisher, Air Consumption, working: 31 SCFM (4.3 CFM) [121.8 l/min.]													
222-3069	620kPa (90 PSIG)	34 SCFM (4.8 CFM) [135.9 l/min.]	1	2600 RPM	84 dBa	5/8 in - 11 UNC	178 mm (7 in)	231-9465	1/4 in - 18 NPT	8 mm (5/16 in)	410 mm (15.74 in)	—	—

Air Grinders

Warranty: Manufacturer, 18 Month

European Union Compliant, CE marked

- Aluminum housing reduces weight and provides durable long life
- Compact design for easy maneuvering in restricted areas
- Paddle-style, variable speed throttle safety trigger prevents accidental startup; easy to use, versatile
- Ball bearing mounted air motor reduces vibration and operator fatigue; prolongs motor life
- Powerful .2 horsepower motor
- Angle head zirk grease fitting (right angle only) allows lubrication of gear train, prolongs life of tool

Repair Information

The Tool Repair Center can help with questions about repair options, calibration details, or general customer service needs.

Call +1(262) 656-4769 worldwide or in North America, toll-free at (855) 351-0926 or send an email to catwarranty@sna-pon.com.



Part Number	Air Pressure	Air Con- sump, Free Speed	Horse power	Sound Level, Free Speed	Air Inlet Thread Size	Hose Size, ID min.	Collet Size	Overall Length	Max Operat- ing Speed	Wheel Capacity	Weight	Length	Sound Level	Air Con- sump, Under Load	Spindle Thread Size
7 in Angle Grinder															
222-3071	—	8 l/s (18 cfm)	—	—	—	—	—	—	6,000 RPM	175 mm (7 in)	2.7 kg (5.9 lb)	315 mm (12.4 in)	85 dBa	17 l/s (35 cfm)	5/8 in - 11
Medium Mini Die Grinder															
222-3074	620 kPa (90 PSIG)	25 SCFM (3.5 CFM) [99.11 l/ min]	0.2	91 dBa	1/4 in - 18 NPT	8 mm (5/ 16 in)	1/4 in	165 mm (6.5 in)	22,000 RPM	—	1.09 kg (2.4 lb)	—	—	—	—
Right Angle Die Grinder															
222-3076	620 kPa (90 PSIG) (1)	15 SCFM (2.1 CFM) [59.47 l/ min]	0.2	93 dBa	1/4 in - 18 NPT	8 mm (5/ 16 in)	1/4 in	140 mm (5.5 in)	20,000 RPM	—	.64 kg (1.4 lb)	—	—	—	—
Extended Die Grinder															
222-3077	620 kPa (90 PSIG)	25 SCFM (3.5 CFM) [99.11 l/ min]	0.2	91 dBa	1/4 in - 18 NPT	8 mm (5/ 16 in)	1/4 in	293 mm (11.5 in)	22,000 RPM	—	1.05 kg (2.5 lb)	—	—	—	—

Pneumatic Tools — Drills

Air Drills



Warranty: Manufacturer, 18 Month

European Union Compliant, CE marked

- Aluminum housing reduces weight and provides durable long life
- Compact design for easy maneuvering in restricted areas
- Contoured button style variable speed trigger is easy to use; versatile
- Ball bearing mounted air motor reduces vibration and operator fatigue; prolongs motor life
- Powerful, reversible .3 horsepower motor

Repair Information

The Tool Repair Center can help with questions about repair options, calibration details, or general customer service needs.

Call +1(262) 656-4769 worldwide or in North America, toll-free at (855) 351-0926 or send an email to catwarranty@snapon.com.

Part Number	Free Speed Air Consumption	Working Air Consumption	Horsepower	Free Speed	Sound Level, Free Speed	Sound Level, Working	Spindle Thread Size	Torque Range	Air Inlet Thread Size	Recommended Hose Size, ID min.	Recommended air pressure	Overall Length	Weight	Drill Chuck (Key)	Drill Chuck (Keyless)
3/8 in Reversible Air Drill: Chuck Range, Diameter: 1/16 in - 3/8 in															
222-3061	71 SCFM (10 CFM) [283.2 l/min.]	43 SCFM (6 CFM) [169.9 l/min.]	0.3	2,200.0 RPM	92 dBa	104 dBa	3/8 in - 24 UNF	0-4 N•m (0-35 in-lb)	1/4 in - 18 NPT	8 mm (5/16 in)	620 kPa (90 PSIG)	199 mm (7.83 in)	.45 kg (2.85 lb)	243-6496	234-0544
1/2 in Reversible Air Drill															
222-3062	71 SCFM (10 CFM) [283.2 l/min.]	43 SCFM (6 CFM) [169.9 l/min.]	0.3	900.0 RPM	97 dBa	109 dBa	3/8 in - 24 UNF	0-6.8 N•m (0-60 in-lb)	1/4 in - 18 NPT	8 mm (5/16 in)	620 kPa (90 PSIG)	224.8 mm (8.85 in)	1.61 kg (3.55 lb)	243-6495	234-0545

Air Hammer - 222-3080



Warranty: Manufacturer, 18 Month

European Union Compliant, CE marked

- Aluminum housing reduces weight and provides durable long life
- Variable speed trigger is easy to use, versatile
- Air directed exhaust
- Air line filter
- Nylon friction plugs
- Long barrel for easier access to hard to reach areas
- QC chuck

Repair Information

The Tool Repair Center can help with questions about repair options, calibration details, or general customer service needs.

Call +1(262) 656-4769 worldwide or in North America, toll-free at (855) 351-0926 or send an email to catwarranty@snapon.com.

Part Number	Recommended Air Pressure	Air Consumption	Sound Level, Free Speed	Blows/Minute	Air Inlet Thread Size	Recommended Hose Size, ID min.	Overall Length	Weight	Spring Retainer Part Number
Long Air Hammer w/QC Chuck									
222-3080	620 kPa (90 PSIG)	28.5 SCFM (4 CFM)	100 dBa	2200	1/4 in - 18 NPT	10 mm (3/8 in)	318 mm (12.5 in)	2.5 kg (5.5 lb)	232-0756

Air Hammer Accessories

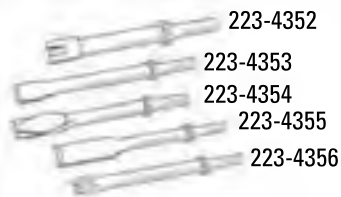

Warranty: Caterpillar Standard Warranty, 6 Months

- Used with 222-3080 Air Hammer
- Material: tungsten carbide steel

Part Number	Description	Width	Length	Shank Diameter	Use
223-4352	Sheet Metal Ripper	5/8 in	5 in	—	—
223-4353	Flat Chisel	3/4 in	7 in	—	—
223-4354	Panel Cutter	3/4 in	6 in	—	Slices bushings, cylinder sleeves, etc.
223-4355	Slitting Chisel	1 in	6 7/8 in	—	Cuts exhaust and tail pipes
223-4356	Weld Breaker	5/8 in	6 3/4 in	—	—
226-0102	Punch, 15 Degree	—	228.6 mm (9 in)	10.18 mm (0.4 in)	—
226-0124	Straight Punch	—	228.6 mm (9 in)	10.18 mm (0.4 in)	—

Pneumatic Tools — Ratchet

Air Ratchet - 222-3059



Warranty: Manufacturer, 18 Month

European Union Compliant, CE marked

- Aluminum housing reduces weight and provides durable long life
- Versatile, easy-to-use paddle-style trigger; variable speed trigger
- Ball bearing mounted air motor reduces vibration and operator fatigue; prolongs motor life
- 200 RPM free speed, 250 in-lbs torque output — fast and powerful

Repair Information

The Tool Repair Center can help with questions about repair options, calibration details, or general customer service needs.

Call +1(262) 656-4769 worldwide or in North America, toll-free at (855) 351-0926 or send an email to catwarranty@snapon.com.

Part Number	Drive	Recommended Air Pressure	Free Speed Air Consumption	Free Speed	Sound Level, Free Speed	Torque Range	Air Inlet Thread Size	Recommended Hose Size	Overall Length	Weight
222-3059	3/8 in	620 kPa (90 PSIG)	22 SCFM (3.0 CFM)	200 RPM	95.1 dBa	7-81 N•m (5-60 ft-lb)	1/4 in - 18 NPT	10 mm (3/8 in)	256 mm (10.43 in)	1.09 kg (2.4 lb)

Shears - 222-3083



Warranty: Manufacturer, 18 Month

European Union Compliant, CE marked

Repair Information

The Tool Repair Center can help with questions about repair options, calibration details, or general customer service needs.

Call +1(262) 656-4769 worldwide or in North America, toll-free at (855) 351-0926 or send an email to catwarranty@snapon.com.

Part Number	Recommended Air Pressure	Average Air Consumption	Horsepower	Sound Level, Free Speed	Sound Level, Working	Cutting Capacity	Cut Width	Cutting Speed	Strokes	Air Inlet Thread Size	Recommended Hose Size, ID min.	Overall Length	Weight
222-3083	620 kPa (90 PSIG)	4 CFM [113.3 l/min.]	0.6	88.1 dBa	99.6 dBa	1.2 mm (3/64 in)	5.6 mm (7/32 in)	4.572 m (15 ft) per minute	2500 per minute	1/4 in - 18 NPT	8 mm (5/16 in)	254 mm (10 in)	1.3 kg (2.8 lb)

Pneumatic Snap Ring Tool - 430-4389



Warranty: Manufacturer, One Year

- Light weight
- Easy to use
- Ergonomic design
- Handles snap rings 0.25 - 6 inch (0.6 - 15 cm)

Description	Part Number
Snap Ring Tool	430-4389
Replacement Tips (Warranty: Caterpillar Standard Warranty, 6 months)	
Straight	430-4392
45-degree Angle	430-4394
90-degree Angle	430-4396

Pneumatic Tools — Engraver

Air Engraver - 223-1154



Warranty: Caterpillar Standard Warranty, 6 Months

European Union Compliant, CE marked

Air Engraver Needles

- Punch 3/16 inch diameter starting hole
- Material: tungsten carbide steel

Repair Information

The Tool Repair Center can help with questions about repair options, calibration details, or general customer service needs.

Call +1(262) 656-4769 worldwide or in North America, toll-free at (855) 351-0926 or send an email to catwarranty@snapon.com.

Part Number	Description	Recommended Air Pressure	Average Air Consumption	Free Speed	Sound Level	Air Inlet Thread Size	Recommended Hose Size, ID min.	Hose Length	Overall Length Without Hose	Weight
223-1154	Air Engraver	620 kPa (90 PSIG)	7 SCFM (1.0 CFM)	14000 RPM	90.0 dBa	1/4 in - 18 NPT	10 mm (3/8 in)	1,511 mm (59.49 in)	140 mm (5.5 in)	.22 kg (.48 lb)
Air Engraver Needles										
223-4357	Needle, Coarse	—	—	—	—	—	—	—	—	—
223-4358	Needle, Medium	—	—	—	—	—	—	—	—	—
223-4359	Needle, Fine	—	—	—	—	—	—	—	—	—

Safety Air Guns

Warranty: Caterpillar Standard Warranty, 6 Months

High Power Extension Air Gun



- Versatile tool ideal for cleaning hard-to-reach locations
- Good for cleaning benchtops, workstations, machinery, and equipment
- Venturi tip increases the power and limits static pressure to less than 207 kPa (30 PSI) when tip is blocked
- Includes durable cast aluminum, pistol-style body, aluminum extension, and zinc alloy nozzle
- 1/4 inch FNPT inlet
- Meets OSHA standards

Part Number	Description	Size
156-0930	Safety Air Gun	61 cm (24.0 in)
156-0931	Safety Air Gun	91 cm (36.0 in)
156-0932	Safety Air Gun	122 cm (48.0 in)

Jet Guard Safety Air Gun - 441-5255



Warranty: Manufacturer, one year

- Safety air shield – patented protective air cone protects operator from chip fly-back
- Delivers high thrust with pinpoint accuracy
- Adjustable air volume – from a “blast” to a “whisper”
- Ergonomic, pistol grip handle provides maximum comfort
- Wide comfort trigger
- Built in hanger for easy storage
- Pinned, tamper proof nozzle
- Durable cast aluminum body
- 1/4 inch NPT/BSPT inlet
- Specs at 100 psi (6.9 bar)
 - Operating pressure 40-120 psi (2.8 – 8.3 bar)
 - Output thrust: 0.4 lbs (1.8 N)
 - Noise level: 102 dBA
 - Air usage: 35 cfm (991 l/m)
 - Weight: 0.6 lbs (272 g)
- Meets OSHA standards
- CE marked

Pneumatic Tools — Air Guns

Jet Guard Safety Air Gun



Warranty: Caterpillar Standard Warranty, 6 Months

- Patented protective air cone protects operator from chip fly-back
- Delivers high thrust with pinpoint accuracy
- Knurled adjusting nut controls air volume
- Ergonomic pistol grip and trigger reduce hand fatigue
- Good for cleaning machine tools and other production equipment
- Built in hanger for easy storage
- Durable cast aluminum body
- 1/4 inch NPT inlet
- Meets OSHA standards

Part Number	Description
156-0927	Jet Guard Safety Air Gun

Safety Blow Guns



Warranty: Caterpillar Standard Warranty, 6 Months

- Supplies non-aspirating, high velocity, sharply defined, collimated air stream particularly suited for cleaning small blind holes and cavities
- Complies with OSHA standard 1910.242(b) for dead-ended nozzle pressure and noise limitation
- For use with inlet pressure up to 150 psig
- Lightweight all metal construction
- 1/4 inch FNPT inlet

Part Number	Description	Test Lab Listing
4C-3302	Air Blow Gun w/Nozzle Assembly	UL/FM
4C-3304	Nozzle w/152 mm (6 in) Extension	—

Gun Vac[®]



Warranty: Caterpillar Standard Warranty, 6 Months

- Rugged aluminum construction
- Uses standard shop compressed air
- No motor, wires, or electrical fields
- Creates twice the vacuum suction of conventional electric shop vacuums
- Reusable collection bag
- Includes brush and 23 cm (9 in) crevice tool
- Accepts all 1-1/4 inch vac accessories
- 1/4 inch NPT inlet

Gun Vac (Cont'd.)

Part Number	Description
4C-6774	Gun Vac, 551 x 1034 kPa (80-150 PSI)
4C-6775	Reusable Bag, 190 mm x 343 mm (7 1/2 in x 13 1/2 in)
4C-6776	Extension, 457.2 mm (18 in)

Pneumatic Tools — Spray Guns

Pneumatic Syphon Spray Gun - 441-5254

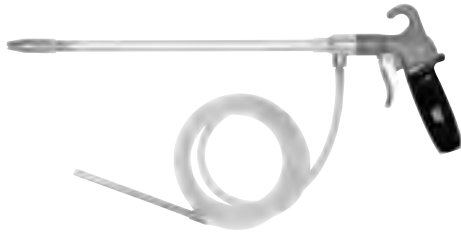

Warranty: Manufacturer, one year

- Ideal for oils, solvents, water, and other liquids
- Ergonomic, rugged, cast aluminum pistol grip designed for heavy-duty use
- High vacuum syphon delivers up to 45 L (12 gal) per hour
- 305 mm (12 in) extension for accessing difficult, hard-to-reach areas
- Wide comfort trigger
- Adjustable trigger and nozzle tip control volume and spray pattern
- Brass nozzle tip
- 1/4 inch NPT/BSPT inlet
- Specs at 100 psi (6.9 bar)
 - Operating pressure 40-120 psi (2.8 – 8.3 bar)
 - Flow rate: 16 gph (1 l/m)
 - Air usage: 9 cfm (255 l/m)
 - Weight: 1.5 lbs (680 g)
- CE marked

Pneumatic Syphon Spray Gun - 4C-5746



Warranty: Caterpillar Standard Warranty, 6 Months

- Ergonomic, rugged, die cast aluminum pistol grip designed for heavy-duty use
- High vacuum syphon delivers up to 45 L (12 gal) per hour
- 304.8 mm (12 in) extension for accessing difficult, hard-to-reach areas
- Adjustable trigger and nozzle tip control volume and spray pattern
- 183 cm (6 ft) 1/4 inch PVC feed
- Brass nozzle tip
- 1/4 inch NPT inlet
- Meets OSHA standards

Part Number	Description
4C-5746	Pneumatic Syphon Spray Gun

Spray Gun Canister



Warranty: Caterpillar Standard Warranty, 6 Months

- 0.94 L (1 qt) canister attaches to spray gun eliminating feed tubes and buckets
- Increased mobility reduces the risks of spills

Part Number	Description
4C-6778	Spray Gun Canister

Pneumatic Oil Gun



Warranty: Caterpillar Standard Warranty, 6 Months

- Ergonomic, rugged, die cast aluminum construction pistol grip designed for heavy-duty use
- High vacuum syphon delivers up to 49.2 L (13 gal) per hour
- 304.8 mm (12 in) extension for accessing hard-to-reach areas
- Adjustable trigger and nozzle tip control volume and spray pattern
- 0.95 L (1 qt) steel, reusable dispenser eliminates feed tubes and buckets
- Good for lubricating trucks, automobiles, construction equipment, and machinery
- 1/4 inch NPT inlet
- Meets OSHA standards
- Conforms to MIL-O-14 559C

Part Number	Description
4C-6779	Pneumatic Oil Gun

Torque Tools — Torque Wrenches, Adapters, and Extensions

Cat Electronic Torque Wrenches



Warranty: Manufacturer, 1 Year

- Just the set torque and the wrench will beep and flash a green light when the desired torque is reached
- Torques clockwise and counterclockwise
- Provides torque angle
- Easy-to-read display shows torque in real time
- 15-Degree Flex Ratcheting Head
- Push Button Socket Release
- Ergonomically designed molded non-slip rubber grip
- Remembers last unit and torque setting
- Scales include: foot pounds, inch pounds, kilogram centimeters, or newton meters
- Comes with a case
- N.I.S.T. traceable certificate of calibration
- CE-marked

Repair Information

The Tool Repair Center can help with questions about repair options, calibration details, or general customer service needs.

Call +1(262) 656-4769 worldwide or in North America, toll-free at (855) 351-0926 or send an email to catwarranty@snapon.com.

Part Number	Drive	Accuracy	Head Type	Torque Range	Length
384-6821	3/8 in	± 2% CW / ± 3% CCW	Flex Ratchet	13.6 N·m - 135.6 N·m (5 ft·lb - 100 ft·lb)	17 in (43 cm)
384-6822	1/2 in	± 2% CW / ± 3% CCW	Flex Ratchet	33.8 N·m - 338 N·m (25 ft·lb - 250 ft·lb)	27 in (68 cm)

Torque Tools — Torque Wrenches, Adapters, and Extensions

Click Type Torque Wrenches

Warranty: Manufacturer, 90 Day

Style A

A



- Work only in the right-hand or clockwise direction, and are guaranteed to be accurate within 4% of setting of the top 80% of the scale
- Easily adjusted by a small calibrated dial along the wrench arm
- Eliminates the need to reduce the torque setting to the low end of the scale for storage in order to retain accuracy
- The 162-8718 Torque Wrench can be disassembled into three components for storage in a tool box

B

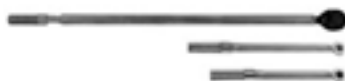

Style B

- Includes a certificate of calibration
- Work in both right and left-hand (clockwise and counter-clockwise) directions
- Micrometer handle style adjustment
- These wrenches are labeled in both ft-lbs and N•m
- Includes a certificate of calibration

Repair Information

The Tool Repair Center can help with questions about repair options, calibration details, or general customer service needs.

Call +1(262) 656-4769 worldwide or in North America, toll-free at (855) 351-0926 or send an email to catwarranty@snapon.com.

Style	Part Number	Minimum Torque Range	Max. Torque Range	Drive	Accuracy	Head Type	Increments	Length	Head Width	Head Depth	Case Included	Kit Part Number	Kit Part Number
A	162-8718	271 N•m (200 ft•lb)	813.5 N•m (600 ft•lb)	3/4	±4%	Detach-Ratchet	13.6 N•m (10 ft•lb)	1219.2 mm (48 in)	60.32 mm (2 3/8 in)	31.75 mm (1 1/4 in)	—	160-6390 ⁽¹⁾	260-3766 ⁽²⁾
A	4C-5492	27.1 N•m (20 ft•lb)	135.6 N•m (100 ft•lb)	3/8	±4%	Flex-Ratchet	2.71 N•m (2 ft•lb)	447.67 mm (17 5/8 in)	28.57 mm (1 1/8 in)	14.28 mm (9/16 in)	Yes	4C-5819 ⁽¹⁾	260-3764 ⁽²⁾
A	8T-9293	54.5 N•m (40 ft•lb)	341.67 N•m (252 ft•lb)	1/2	±4%	Flex-Ratchet	6.8 N•m (5 ft•lb)	591.97 mm (22 1/8 in)	41.27 mm (1 5/8 in)	19.05 mm (3/4 in)	Yes	5P-7429 ⁽¹⁾	260-3765 ⁽²⁾
B	386-3340	1.4 N•m (0.83 ft•lb)	5.4 N•m (4.2 ft•lb)	1/4	±4% CW, ±6% CCW	Fixed Ratchet	1.35 N•m (1 ft•lb)	258 mm (10.2 in)	—	—	Yes	—	—
B	214-7349	27.1 N•m (20 ft•lb)	203.6 N•m (150 ft•lb)	1/2	±6%	Fixed Ratchet	1.4 N•m (1 ft•lb)	469.9 mm (18.5 in)	—	—	Yes	214-7350	—
B	9U-5006	40.7 N•m (30 ft•lb)	339.3 N•m (250 ft•lb)	1/2	±6%	Fixed Ratchet	1.4 N•m (1 ft•lb)	539.6 mm (21.25 in)	—	—	Yes	—	—
B	9U-5007	135.7 N•m (100 ft•lb)	814.2 N•m (601 ft•lb)	3/4	±6%	Fixed Ratchet	7.0 N•m (5.2 ft•lb)	1092.2 mm (45 in)	—	—	Yes	—	—
B	9U-5019	6.8 N•m (5 ft•lb)	101.8 N•m (75 ft•lb)	3/8	±6%	Fixed Ratchet	0.7 N•m (0.5 ft•lb)	393.7 mm (15.5 in)	—	—	Yes	—	—
B	9U-5020	13.6 N•m (10 ft•lb)	135.7 N•m (100 ft•lb)	3/8	±6%	Fixed Ratchet	0.7 N•m (0.5 ft•lb)	393.7 mm (15.5 in)	—	—	Yes	—	—
B	386-3348	271.2 N•m (200 ft•lb)	1355.8 N•m (1000 ft•lb)	1	±4% CW, ±6% CCW	Fixed Ratchet	6.8 N•m (5 ft•lb)	1753 mm (69 in)	—	—	Yes	—	—

1 Service Kit for ratchets that have brand on the head

2 Service Kit for ratchets that do not have brand on the head

Torque Tools — Torque Wrenches, Adapters, and Extensions

Dial Type Torque Wrenches



Warranty: Lifetime

- Accuracy within 2% of the reading within the upper 80% of the scale
- Wrenches with follow-up needle use two pointers on the dial which move as one as long as pressure is applied and one remains at the maximum torque reading until reset
- Wrenches with light indicator features a light which comes on when the torque setting is reached
- Work in both right and left-hand (clockwise and counter-clockwise) directions

Repair Information

The Tool Repair Center can help with questions about repair options, calibration details, or general customer service needs.

Call +1(262) 656-4769 worldwide or in North America, toll-free at (855) 351-0926 or send an email to catwarranty@snapon.com.

Part Number	Torque Range	Drive U.S.	Drive	Accuracy	Metric Graduations	English Increments	Length	Needle Included	Light Indicator Included	Case Included
9S-7351	800.0 N-m	600 ft-lb	3/4 in	±2%	20.0 N-m	10 ft-lb	103.9 cm (40.9 in)	–	Yes	–
9S-7352	480.0 N-m	350 ft-lb	3/4 in	±2%	10.0 N-m	5 ft-lb	75.9 cm (29.9 in)	Yes	–	–
9S-7353	230.0 N-m	175 ft-lb	1/2 in	±2%	10.0 N-m	2.5 ft-lb	47.6 cm (18.75 in)	Yes	–	–
9S-7354	34.0 N-m	300 in-lb	3/8 in	±2%	1.0 N-m	5 in-lb	25.2 cm (9.9 in)	Yes	–	–
9U-5017	35.0 N-m ⁽³⁾	300 in-lb	3/8 in	±4%	1.0 N-m	5 in-lb	25.4 cm (10.0 in)	Yes	–	Yes

Heavy-Duty Box Wrenches



Warranty: Lifetime

- Used for fasteners in inaccessible places, such as track roller guard bolts, where a torque wrench and standard socket cannot be used

Repair Information

The Tool Repair Center can help with questions about repair options, calibration details, or general customer service needs.

Call +1(262) 656-4769 worldwide or in North America, toll-free at (855) 351-0926 or send an email to catwarranty@snapon.com.

Part Number	Hex Size	Straight/Config.	Offset	Torque
262-2758	20 mm	12 pt	straight	650 ft-lb
262-2759	30 mm	12 pt	straight	650 ft-lb
4C-9563	24 mm	12 pt	straight	650 ft-lb
6V-4165	19 mm	12 pt	straight	650 ft-lb
6V-4166	7/8 in	12 pt	straight	650 ft-lb
6V-4167	15/16 in	12 pt	straight	650 ft-lb
6V-4168	1 1/8 in	12 pt	straight	650 ft-lb
6V-4169	1 5/16 in	12 pt	straight	650 ft-lb
6V-4171	15/16 in	12 pt	15° offset	–

Torque Tools — Torque Wrenches, Adapters, and Extensions

Heavy-Duty Box Wrenches (Cont'd.)

Part Number	Hex Size	Straight/Config.	Offset	Torque
Shown Below				
6V-4154	1 1/2 in	12 pt	straight	650 ft-lb

Torque Wrench Extensions

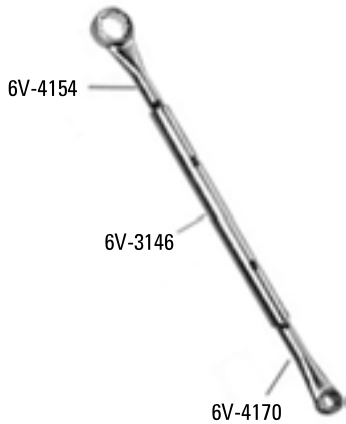

Warranty: Lifetime

- Has an effective length of 610 mm (24 in) and a capacity up to 884 N•m (650 ft-lb)
- A slide rule type torque computer, Form SEHS7150, is available to determine the torque wrench dial reading for different extensions

Part Number	Description
6V-3146	Tubular Extension
6V-4154	Heavy-Duty Box Wrench
6V-4170	Adapter, 3/4 inch, Sq. Drive

Adapters and Extensions for Torque Wrenches



Warranty: Lifetime

- The 8S-5131 and 1P-2382 Adapters are used with the 9S-7353 or 9U-5014 Torque Wrench
- The 8F-4677 Extension and 8F-4678 Adapter are used with the 9S-7352 or 9U-5015 Wrench to increase the capacity of the wrench

Part Number	Description	Use
156-2568	Adapter, 3/8 inch drive, 10 mm, 12 point box end	—
1P-2382	Adapter (1/2 inch Drive, 3/4 inch 12 Point Box End)	for universal joint bolts on all tractor-scrapers (except 613) and No. 16 Motor Graders
5P-0166	Crowfoot Wrench (3/8 inch Drive, 3/4 inch Hex)	for torquing fuel line nuts on D3 Tractors, 910 Wheel Loaders and 931 Track Loaders
8F-4677	Extension, 3/4 inch Drive, 26 7/8 inch center to center	use to double capacity of 8F-4675 and 9S-7352 Torque Wrenches for torque applications up to 700 ft.lb.
8F-4678	Adapter Driver (3/4 inch Drive)	for use with 8F-4677 Extension
8T-3196	Offset Box Wrench	3/4 inch Drive, 1 7/8 inch Hex, 12 pt
9U-6282	Crankshaft Main Bearing on 3054 and 3056 Engines. 1/2 inch Sq. Drive, 15/16 inch Hex, 12 pt	—
386-3349	Offset Handle	1/2 inch square drive; 375 mm (14.76 in) offset; 559 mm (22 in) long
317-2806	1/2 in Drive Adapter with 5/8 inch Box End	—

Torque Tools — Torque Wrenches, Adapters, and Extensions

Special Torque Wrench Extensions

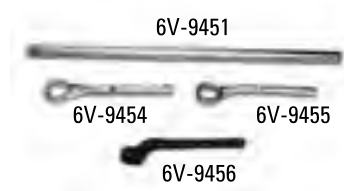

Warranty: Lifetime

- Extensions listed below are used with the 6V-9451 Tubular Arm, and the 9S-7352 Torque Wrench primarily for applications up to 1000 ft-lb (1360 N·m)
- A torque computer (376-4937), can be used to compute the correct torque wrench reading for proper torque application at the fastener

Part Number	Description	Use
6V-9451	Tubular Arm	—
6V-9454	Wrench, 1 7/8 inch	Tighten mounting stud nuts on 55, 56, 57, 58 and 59 Towing Winches.
6V-9455	Wrench, 1 7/8 inch	Tighten mounting stud nuts on 55 and 56 Towing Winches
6V-9456	Wrench, 1 11/16 inch	Tighten steering cylinder tie rod bolt nut on No. 16G Motor Graders.
435-3382	Wrench, 1 1/4 inch	—

Torque Computer - 376-4937



Warranty: Caterpillar Standard Warranty, 6 Months

- Used for calculating proper torque when using an extension with analog and digital torque wrenches

Part Number	Description
376-4937	Torque Computer

Degree Wheel - 8T-3052



Warranty: Lifetime

- Used for measuring torque turn angles
- The nut or bolt does not have to be marked in order to obtain the correct torque

Part Number	Description	Size
8T-3052	Degree Wheel	1/2 in drive; can be used with any standard 1/2 in drive socket

Mechanical Torque Tester - 1P-7460



Warranty: Manufacturer, Lifetime

- Torque wrenches can be checked quickly and easily
- Furnished with 3/8 inch, 1/2 inch and 3/4 inch adapters to accommodate Cat torque wrenches
- Certified accuracy is $\pm 1\%$ or one scale division, whichever is greater

Part Number	Description	Torque Range
1P-7460	Mechanical Torque Tester	680.0 N·m (502 ft-lb)

Torque Tools — Torque Testers

Electronic Torque Testers



Warranty: Manufacturer, 90 Day

European Union Compliant, CE marked

- Accuracy better than 1% of the indicated value in ranges between 10% to 100% of maximum rating
- Maximum overtorque of 120% of full rating
- Reliable "first-peak" mode for tests of click type torque wrenches without the need for manual sensitivity adjustment—a red light and buzzer indicate capture of first torque peak. Other modes include "peak hold" which records the highest reading during a test and "track" which displays continuously during use.
- Equally accurate in clockwise and counter-clockwise directions
- Automatic or manual display reset
- Unique adjustable head moves for easy reading
- Rechargeable battery with 110 V AC adapter included (not available separately)

Note: Use 9U-5101 mounting bracket to mount the testers to a bench top. No bracket is required to mount testers to a vertical surfaces.

Repair Information

The Tool Repair Center can help with questions about repair options, calibration details, or general customer service needs.

Call +1(262) 656-4769 worldwide or in North America, toll-free at (855) 351-0926 or send an email to catwarranty@snapon.com.

Part Number	Torque Range	Drive U.S.	Size
9U-5009	12 to 57 N·m	10 to 50 in-lb	1/4
9U-5010	57 to 282 N·m	50 to 250 in-lb	3/8
9U-5011	226 to 1130 N·m	200 to 1000 in-lb	3/8
9U-5012	68 to 339 N·m	50 to 250 ft-lb	1/2

Megaboost Lock-n-Load Grease Gun - 385-1742



Warranty: Manufacturer, five years

- Threadless quick connect barrel makes for fast and easy reloads
- Dual piston design gives the gun two modes, Volume mode and Megaboost mode
- Megaboost mode delivers 10,000 PSI to clear blocked zerks
- Automatic bleeder
- 3-way loading
- Ergonomic handle
- High pressure 4-jaw coupler

Part Number	Description
385-1742	Megaboost Lock-n-Load Grease Gun

Workforce Pro Grease Gun - 385-1743



Warranty: Manufacturer, five years

- Threadless quick connect barrel makes for fast and easy reloads
- Automatic bleeder
- 3-way loading
- Ergonomic handle
- High pressure 4-jaw coupler

Part Number	Description
385-1743	Workforce Pro Grease Gun

Lever Grease Gun, Model Pro "L" - 8F-9866



Warranty: Caterpillar Standard Warranty, 6 Months

- Heavy-duty construction
- Cast iron head equipped with a check valve and an air-bleed valve
- Spring primed
- Two way loading
- Uses standard Cat Grease cartridges (14.5 oz)
- Lever gun will operate with partial lever strokes for use in close quarters
- Zinc plated
- Cat branded
- Maximum operating pressure of assembly: 68,948 kPa (10,000 PSI)

Grease Guns

Lever Grease Gun, Model Pro "L" - 8F-9866 (Cont'd.)

Part Number	Description
8F-9866	Cat Pro "L" Grease Gun ⁽¹⁾
8F-9866 Consists of	
190-1668	Coupler
190-1669	Hose Assembly, 12 in long
Optional	
190-5623	Hose Assembly, 18 in long
Service Parts for Noncurrent 8F-9866 (This model is not marked Pro L and uses the 2M-2689 or 190-1670 Coupler with a check valve)	
190-1670	Coupler (valve with steel insert)
2M-2689	Coupler (valve with rubber insert)
9F-2636	Nozzle Assembly ⁽²⁾
9F-2637	Nipple (part of 9F-2636)

Pistol Grip Grease Gun - 190-5622



Warranty: Caterpillar Standard Warranty, 6 Months

- Heavy-duty construction
- Cast iron head equipped with a check valve and an air-bleed valve
- Spring primed
- Two way loading
- Uses standard Cat Grease cartridges (14.5 oz)
- Lever gun will operate with partial lever strokes for use in close quarters
- Zinc plated
- Cat branded
- Maximum operating pressure of assembly: 31,026 kPa (4,500 PSI)

Part Number	Description
190-5622	Pistol Grip Grease Gun
Grease Gun Consists of:	
190-1668	Coupler
190-5623	Hose Assembly, 18 in long
Optional	
190-1669	Hose Assembly, 12 in long

¹ Warranty: Six Months

² Warranty: Manufacturer, 30 Day

Electric Grease Gun



Warranty: Manufacturer, one year

- 20v, 1.5 Ah lithium-ion grease gun
- 10,000 psi maximum
- Two-flow rates: High - 6oz (170g) per minute and Low - 3.2oz (90.7oz) per minute
- Delivers up to 15 cartridges per hour on a single charge
- 70-min battery recharge
- LCD displays:
 - Grease meter in ounces or grams
 - Grease level gauge
 - Battery level gauge
 - Troubleshooting information
- Built-in LED flashlight
- Carrying case

Part Number	Description	Charger Voltage
463-3105	20v, 1.5 Ah lithium-ion grease gun	110v, 60hz
463-3106	20v, 1.5 Ah lithium-ion grease gun	220v, 50hz

Cordless Electric Grease Gun - 241-0706



194-3560

Warranty: Manufacturer, 1 Year

- 12 Volt cordless, rechargeable grease gun
- Custom carrying case holds grease gun with battery, battery charger, and two grease cartridges (grease not included)
- 12 Volt motor delivers consistent grease flow up to 41368 kPa (6000 PSI)
- Works great in construction and agricultural field conditions
- Provides faster, more effective lubrication (reduces mechanic's fatigue when lubricating large numbers of grease fittings)
- Three-way loading to fit your needs and equipment (suction, filler pump, and cartridge)
- Uses standard 14 ounce cartridges
- Comes with a 76 cm (30.0 in) flex hose with spring guards
- One hour "fast charge" charges batteries quickly; trickle charge keeps batteries fully charged when placed in charger

Specifications	
Motor	12 Volt
Battery	high-capacity, 12 Volt NiCad
Pressure capacity	41368 kPa (6000 PSI)
Charge time	1 hour (110 V, 60 Hz)
Front outlet fitting	7/16 inch UNEF

Grease Guns

Cordless Electric Grease Gun - 241-0706 (Cont'd.)

Specifications	
Filler nipple thread	1/8 inch NPT
Lubricating capacity (under normal conditions)	3 cartridges minimum
Battery capacity	1300 m-A hour
Battery charger	110 Volt

Part Number	Description
241-0706	Grease Gun Group with 2 Batteries
274-1677	Battery Charger
207-2736	Hose Assembly, 762 mm (30 in)

Screwdriver Set, 5 Piece - 233-1640

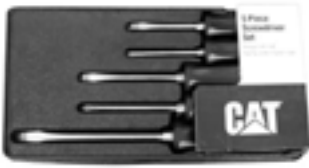

Warranty: Lifetime

- Exclusive high-tech handle for a more comfortable grip and more powerful performance

Part Number	Size	Description
233-1640	—	Screwdriver Set
Set Consists of:		
6V-7932	3/8 in tip, 342.1 mm (13.47 in) long	Standard Screwdriver
6V-7933	5/16 in tip, 277.11 mm (10.91 in) long	Standard Screwdriver
6V-7934	No. 2 Phillips tip, 213.6 mm (8.41 in) long	Phillips Screwdriver
6V-7936	No. 1 Phillips tip, 162.9 mm (6.66 in) long	Phillips Screwdriver
6V-7937	3/16 in tip, 260 mm (9.44 in) long	Standard Screwdriver

Screwdriver Set - 9U-7290



Warranty: Lifetime

- Exclusive high-tech handle design for a more comfortable grip and more powerful performance

Part Number	Description	Size
9U-7290	Screwdriver Set	Includes a flat 1/4 in tip and #1 Phillips

Black Plastic Handle Screwdriver Set, 6 Piece - 162-7804



Warranty: Lifetime

- Black plastic handles
- 6-piece set
- Includes vinyl pouch

Item	Part Number	Tip Size	Description
—	162-7804	—	Complete Screwdriver Set
Complete Set Consists of:			
1	6V-7937	3/16 in	Standard Screwdriver
2	6V-7935	1/4 in	Standard Screwdriver
3	6V-7933	5/16 in	Standard Screwdriver
4	6V-7932	3/8 in	Standard Screwdriver
5	6V-7936	No. 1	Phillips Screwdriver
6	6V-7934	No. 2	Phillips Screwdriver

Cat Screwdrivers

Black Plastic Handled Screwdrivers



Warranty: Lifetime

- Nickel/chrome-plated blades with vapor-blasted tips for best possible grip on screws
- Heavy duty, high impact handle

Part Number	Tip Size	Length
Standard Tip, Round Shank Screwdrivers		
277-8790	1/2 in	469.0 (18.47 in)
6V-7932	3/8 in	342.1 mm (13.50 in)
6V-7933	5/16 in	277.1 mm (10.91 in)
6V-7935	1/4 in	212.8 mm (8.38 in)
6V-7937	3/16 in	239.8 mm (9.44 in)
6V-7938	1/4 in	100.1 mm (3.94 in)
6V-9124	1/8 in	120.7 mm (4.75 in)
Phillips Tip, Round Shank Screwdrivers		
214-7342	No. 3	276.4 mm (10.88 in)
6V-7934	No. 2	213.6 mm (8.41 in)
6V-7936	No. 1	169.2 mm (6.66 in)

Ratcheting Screwdriver, 5 Bits - 9U-7291



Warranty: Lifetime

Part Number	Description	Size	Length
9U-7291	Ratcheting Screwdriver	3/16 in and 9/32 in flat tips, #1 and #2 Phillips, and #10 Torx stored in hollow handle	222.25 mm (8 3/4 in) long overall; 96.04 mm (3 25/32 in) stainless steel shank length

32-Piece Screwdriver Set 386-3366



Warranty: Caterpillar Standard Warranty, Six Months

- Cushion grip handle
- Strong magnetic grip holds bit securely
- Blast finished tip for added grip

32 Bits Included					
Adapter	Hex	Tamper	Torq	Torx	Tri-wing
1/4 in square to 1/4 in hex	3/32, 7/64, 1/8, 9/64, 5/32, 3/16 in and 2, 2.5, 3, 4, 5 mm	4, 6, 8, 10	6, 8, 10	T7, T8, T10, T15, T20, T25, T27, T30, T40	1, 2, 3, 4

Insulating Screwdriver



Warranty: Caterpillar Lifetime Warranty

- Insulated design with no conductive path to user
- Durable construction with nothing to tear, puncture, or wear away
- Individually tested to protect up to 1,000 volts AC and 1,500 volts DC

Part Number	Description	Sizes
386-3369	Insulated Screwdriver	3 mm Flat
386-3370	Insulated Screwdriver	3 mm Flat

Nutdrivers



Warranty: Caterpillar Lifetime Warranty

Part Number	Description	Sizes
386-3371 ⁽¹⁾	Nutdriver	7/32 in (5.5 mm)
386-3372	Nutdriver	7 mm (0.28 in)

Torx Driver Set

Warranty: Caterpillar Lifetime Warranty

- Ergonomic, durable handles
- Vapor-blasted tips for better grip
- Nut-shaped bolster for hard-to-turn fasteners
- Available as a set or individually

Part Number	Description	Size
431-1522	9-piece Torx Driver Set	—
Individual Drivers		
431-1520	Torx Driver	T8
431-1524	Torx Driver	T10
431-1515	Torx Driver	T15
431-1521	Torx Driver	T20
431-1518	Torx Driver	T25
431-1516	Torx Driver	T27
431-1514	Torx Driver	T30
431-1519	Torx Driver	T40
431-1517	Torx Driver	T45

¹ Caterpillar Warranty: Six Months

Cat Screwdrivers

Torx Driver



Warranty: Caterpillar Lifetime Warranty

- Wide tri-lobe design
- Comfortable handle
- Durable nickel chrome plating

Part Number	Description	Sizes
386-3373	Torx Driver	T10

Tool Bit Set, 6 Piece - 9U-7328



Warranty: Caterpillar Standard Warranty, 6 Months

- High impact, pocket-sized ABS plastic case
- Convenient magnetic bit holder (to fit power drills or for use with the case as a hand-held screwdriver) is included

Part Number	Description	Contents
9U-7328	Tool Bit Set	Includes #1, #2, and #3 Phillips and 6.5 mm x 1.2 mm, 6.0 mm x 1.0 mm, and 5.5 mm x 0.8 mm flat tips

Off-Set Slotted Screwdriver - 5P-0302



Warranty: Caterpillar Lifetime Warranty

- Handy for removing slotted screws in areas with limited access

Part Number	Description
5P-0302	Off-Set Slotted Screwdriver

Yellow Grip Pliers Set, 3 Piece - 233-1639



Warranty: Lifetime

- Hardened cutting edges stay sharper longer and cut with less effort
- Machined cutter heads for matched blades
- Vinyl grip

Part Number	Description	Length
233-1639	Pliers Set	—
Pliers Set Consists of:		
6V-6192	Slip Joint Pliers	208 mm (8 in)
6V-6193	Diagonal Cutting Pliers, 44.45 cm (17 1/2 in)	185.7 mm (7.30 in)
6V-6194	Needle Nose Pliers	181.1 mm (7.13 in)

Cat Locking Pliers Set, 5 Piece - 316-0707



Warranty: Caterpillar Lifetime

- Heavy Duty Locking pliers
- Reinforced teeth
- Cat branded

Part Number	Description	Length
316-0707	Locking Pliers Set with rollup pouch	—
Set Components:		
316-0702	Straight jaws - 1 5/32 in (3 cm)	5 in (13 cm)
316-0703	Curved jaws 1 5/8 in (4 cm)	7 in (17 cm)
316-0704	Hose clamping jaws with curved, straight, and clamp sections — 1 5/32 in (3 cm)	10 in (25 cm)
316-0705	Curved jaws with cutter 2 7/16 in (6 cm)	10 in (25 cm)
316-0706	Straight jaws 7 7/16 in (6 cm)	10 in (25 cm)

Combination and Multiple Position Pliers

Warranty: Lifetime unless otherwise noted



Typ-e	Part Number	Description	Length	Finish	Vinyl Grip
A	213-1983	Combination Pliers	159.3 mm (6.30 in)	Chrome	Yes
A	6V-6192	Slip Joint Pliers	190.5 mm (7.50 in)	Black Oxide	Yes
B	214-7347	Multiple Position Pliers	304.8 mm (12.00 in)	Chrome	Yes

Cat Pliers

Combination and Multiple Position Pliers (Cont'd.)

Typ- e	Part Number	Description	Length	Finish	Vinyl Grip
B	236-1169	Multiple Position Pliers ⁽¹⁾	400.0 mm (16.00 in)	Chrome	Yes
B	6V-6195	Interlocking Joint Pliers	235.0 mm (9.30 in)	Black Oxide	Yes
C	6V-6194	Needle Nose Pliers	181.1 mm (7.13 in)	Black Oxide	Yes
D	6V-6193	Diagonal Cutting Pliers, 44.45 cm (17 1/2 in)	185.7 mm (7.30 in)	Black Oxide	Yes

Soft Jaw Pliers – 6V-0006



Warranty: Caterpillar Standard Warranty, Six Months

- Soft Jaw Pliers with Urethane Jaw Inserts
- Four pivot positions from 3/4 inch to 2 1/4 inch
- High carbon steel with vinyl grips
- Non marring

Part Number	Description	Length
6V-0006	Soft Jaw Pliers	10 in (254 mm)

Retaining Ring Pliers

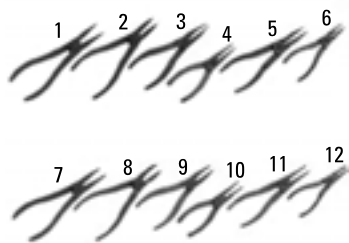

Warranty: Caterpillar Standard Warranty, 6 Months

Item	Part Number	No.	Tip Size	Type
Straight Tips				
1	1P-1863	No. 26	0.12 in	External
2	1P-1861	No. 25	0.09 in	Internal
3	1P-1857	No. 23	0.07 in	Internal
4	1P-1855	No. 22	0.04 in	External
5	1P-1859	No. 24	0.07 in	External
6	1P-1853	No. 21	0.04 in	Internal
Right Angle Tips				
7	1P-1864	No. 26-90	0.12 in	External
8	1P-1862	No. 25-90	0.09 in	Internal
9	1P-1858	No. 23-90	0.07 in	Internal
10	1P-1856	No. 22-90	0.04 in	External
11	1P-1860	No. 24-90	0.07 in	External
12	1P-1854	No. 21-90	0.04 in	Internal

¹ Warranty: Caterpillar Standard Warranty, 6 Months

External Pliers - 5P-5197



Warranty: Caterpillar Standard Warranty, 6 Months

- Use to compress or expand large retaining rings
- A double ratchet locks to hold the handles at any given point without hand pressure
- Gap between the plier tips ranges from 12.7 mm (.50 in) fully closed to 76.0 mm (3.00 in) fully open

Item	Part Number	Description
1	5P-5197	External Pliers
2	136-1452	Internal Pliers Assembly
3 and 4	1U-6728	Tip Set
Not Shown	6V-2062	Tip Set, 90 Degrees

Internal Retaining Ring Pliers - 1U-8758



Warranty: Caterpillar Standard Warranty, 6 Months

- Used to remove and install the large internal retaining rings in power shift transmissions
- Double ratchet lock
- Pliers include 0.15 in (3.8 mm) diameter tips
- Service Part: 1U-8759 Replacement Tips (2 per package)

Part Number	Description	Length
1U-8758	Internal Retaining Ring Pliers	29.00 in (737.0 mm)

Pliers 444-6561



Warranty: Caterpillar six Months

- The hand-held pliers allow accurate assembly and disassembly operations
- The tips of the pliers precisely fit the gripping points on the clamp
- the integrated spring element keeps the pliers open, thus permitting comfortable and fast working

Cat Pliers

External Retaining Ring Pliers - 2P-8312



Warranty: Lifetime

- Used to remove and install tempered steel retaining rings used in many applications
- Right angle tips to provide the necessary clearance where the lock ring is accessible only from a perpendicular position

Part Number	Description
2P-8312	External Retaining Ring Pliers

Hammers and Slide Sledges

Slide Sledge® Heavy Equipment Hammers

Warranty: Manufacturer, 1 Year

- Safe, easy operation by one person to execute specific jobs with greater accuracy than two people with a hammer and chisel
- Varied sizes and weights available for greater force or accessibility



Part Number	Weight	Length	Description
272-1208	9.00 lb	30.00 in	Slide Sledge w/ 2 in diameter pin driver (272-1237)
272-1212	13.00 lb	46.00 in	Slide Sledge w/ 2 in diameter pin driver (272-1237)
272-1215	14.00 lb	30.00 in	Slide Sledge w/ 2 in diameter pin driver (272-1237)
272-1218	21.00 lb	46.00 in	Slide Sledge w/ 2 in diameter pin driver (272-1237)

Slide Sledge Tips

Warranty: Manufacturer, 90 Day

- Various tips for the Slide Sledge Heavy Equipment Hammer to adapt it to various applications



Part Number	Description	Use	Picture Number
272-1228	Pin Driver, 1/2 in diameter	Recommended for pins and bolts 1/2 in - 7/8 in diameter	1
272-1230	Pin Driver, 7/8 in diameter	Recommended for pins and bolts 7/8 in - 1-1/4 in diameter	2
272-1233	Pin Driver, 1 1/4 in diameter	Recommended for pins and bolts 1 1/4 in - 2 in diameter	3
272-1237	Pin Driver, 2 in diameter	Recommended for pins and bolts 2 in - 2 1/2 in diameter	4
272-1239	Pin Driver, 2 1/2 in diameter	Recommended for pins and bolts 2 1/2 in - 3 in diameter	5
272-1240	Pin Driver, 3 in diameter	Recommended for pins and bolts 3 in - 4 in diameter	6
272-1224	Tie Rod/Ball Joint Separator Fork, 11/16 in	Used to separate tie rod ends and ball joints	7
272-1225	Tie Rod/Ball Joint Separator Fork, 15/16 in	Used to separate tie rod ends and ball joints	7
272-1227	Tie Rod/Ball Joint Separator Fork, 1-7/16 in	Used to separate tie rod ends and ball joints	7

Hammers and Slide Sledges

Slide Sledge Tips (Cont'd.)

Part Number	Description	Use	Picture Number
272-1223	Tie Rod/Ball Joint Splitter Adapter	Attach all Slide Sledge separator fork and most common forks available	8
272-1222	Tie Rod/Ball Joint Separator 3 Tip Set	Includes a Slide Sledge separator adapter and 11/16 in, 15/16 in and 1-1/8 in forks	9
272-1242	Ripper Tooth Pin Inserter, 3/4 in diameter	Use on pins as small as 3/4 in up to 1 in with minimum tooth spacing of 4 1/2 in	10
272-1244	Ripper Tooth Pin Inserter, 1/2 in diameter	Use on pins as small as 1/2 in up to 3/4 in with minimum tooth spacing of 3 1/2 in	10
272-1247	Ripper Tooth Pin Inserter, 3/8 in diameter	Use on pins as small as 3/8 in up to 1/2 in with minimum tooth spacing of 2 3/4 in	10
272-1243	Ripper Tooth Pin Remover, 3/4 in diameter	Use on pins as small as 3/4 in up to 1 in with minimum tooth spacing of 4 1/2 in	11
272-1245	Ripper Tooth Remover, 1/2 in diameter	Use on pins as small as 1/2 in up to 3/4 in with minimum tooth spacing of 3 1/2 in	11
272-1246	Ripper Tooth Pin Remover, 3/8 in diameter	Use on pins as small as 3/8 in up to 1/2 in with minimum tooth spacing of 2 3/4 in	11
272-1241	Curved Chisel Tip, 1 3/8 in	For chopping away hardened debris and shearing metal bolts, pins, and rivets up to 3/8 in, grade 8	12
272-1251	Scarifier Tooth Tip	Removes scarifier teeth on most motor graders. The fork design allows the technician to split the trenching arm where the scarifier tooth is forced to fit.	13
272-1252	Utility Wedge Tip	All-purpose impact tool designed to separate parts and straighten steel with maximum force.	14
272-1249	Race/Bearing/Seal Adapter	Adapter driver tip to install races, bearings, and seals. Add drive plates to the end in various combinations. Fits plates with a common 9/16 in center hole, up to 3/4 in high (plates not included)	15
272-1250	Bushing Driver Adapter	Adapter driver tip to properly install bushings easily and quickly. Fits drivers with a common 3/4 in center hole, up to 7/8 in high (drivers not included)	16
272-1248	Bushing/Bearing/Seal Plate Driver Adapter	Adapter driver to install bearings, bushings, and seals. Fits drivers or plates with a 1/4 in center hole. (drivers and plates not included)	17
287-2075	Small Tire Bead Breaker, 2 1/4 in head width	Most standard applications	18
287-2076	Large Tire Bead Breaker, 2 7/8 in head width	Ideal for tractor trailers, backhoes, motor graders, and other large equipment	19

Slide Sledge Accessories

Warranty: Manufacturer, 90 Day



Part Number	Description	Use	Picture Number
272-1253	5 Pound Handle Weight	Increases the Slide Sledge striking force by 5 lbs; works with any of the four tools by threading onto tool handle	1
273-3527	Heavy Nylon Tool Bag	38 in long; For use with the shorter Slide Sledges (272-1208 & 272-1215)	2

Hammers and Slide Sledges

Slide Sledge Accessories (Cont'd.)

Part Number	Description	Use	Picture Number
273-3528	Heavy Nylon Tool Bag	52 in long; For use with the longer Slide Sledges (272-1212 & 272-1218)	3
331-1264	Display Case for Slide Sledge Tools (Dealer Use)	-	-

Slide Sledge Hammer Repair Parts

Warranty: Manufacturer, 90 Day

- Various individual repair parts for the Slide Sledge Heavy Equipment Hammer
- Most repair parts are specific to certain sized Slide Sledges (specified in table below)

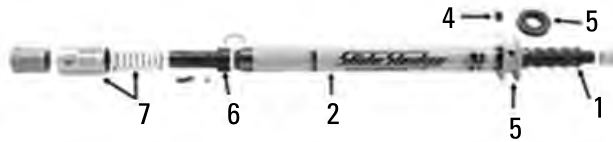

Part Number	Description	Use	Picture Number
312-0985	Drive Bar	Internal drive bar replacement for the 272-1212 Slide Sledge	1
312-0988	Drive Bar	Internal drive bar replacement for the 272-1218 Slide Sledge	1
312-0999	Drive Bar Tube	External main body of 272-1208 Slide Sledge	2
312-1002	Drive Bar Tube	External main body of 272-1215 Slide Sledge	2
312-0992	Hand Guard	Connection point of body and handle for 272-1208 & 272-1212 Slide Sledge	3
312-0996	Slide Lock Pin	Pin for locking the handle on all sized Slide Sledges	4
312-1012	Hand Stop	Rubber piece fitting over drive bar as cushion for operator's hand for 272-1208 & 272-1212 Slide Sledge	5
312-1014	Hand Stop	Rubber piece fitting over drive bar as cushion for operator's hand for 272-1215 & 272-1218 Slide Sledge	5
312-1009	Plunger	Plunger on end of Drive Bar where tips are secured for 272-1208 & 272-1212	6
312-1010	Plunger	Plunger on end of Drive Bar where tips are secured for 272-1215 & 272-1218	6
312-7677	Plunger Parts Kit	Housing and spring that go around the Plunger for 272-1208 & 272-1212	7
312-7678	Plunger Parts Kit	Housing and spring that go around the Plunger for 272-1215 & 272-1218	7

Hammers

Warranty: Lifetime unless otherwise noted



Hammers and Slide Sledges

Hammers (Cont'd.)

Item	Part Number	Size	Height	Length	Weight	Material
Ball Peen Hammers						
1	1S-0257	1 1/8 in	–	298.5 mm (11.75 in)	340 g (12 oz)	–
2	1B-7810	1 5/32 in	113.5 mm (4.47 in)	406.4 mm (16 in)	680 g (1 1/2 lb)	–
3	8H-8577	1 1/4 in	128.6 mm (5.06 in)	406.4 mm (16 in)	900 g (2 lb)	–
–	386-3351	1 7/8 in	76 mm (3 in)	362 mm (14.25 in)	454 g (1.0 lb)	–
–	386-3363	7/8 in	64 mm (2.5 in)	311 mm (12.25 in)	227 g (0.5 lb)	–
Soft Face Hammers						
4	1S-0258	1 11/16 in	117.5 mm (4.63 in)	330.2 mm (13 in)	900 g (2 lb)	–
Replacement Tips for 1S-0258⁽¹⁾						
5	3S-0460	–	–	–	–	Medium tip
6	3S-0459	–	–	–	–	Hard tip
Hammer Handles⁽²⁾						
–	263-3817	305 mm (12 in)	–	–	–	Hickory
–	263-3819	407 mm (16 in) ⁽²⁾	–	–	–	Hickory
–	263-3820	458 mm (18 in)	–	–	–	Hickory

Multiple Use Hammers

Warranty: Lifetime unless otherwise noted



Item	Part Number	Description	Face Diameter	Overall Length	Weight	Size	Material
1	223-1697	Double Face Sledge	47.8	889 mm (35 in)	4.4 kg (9.61 lb)	–	
2	223-1694	Dead Blow Sledge ⁽¹⁾	69.8	508 mm (20 in)	2.5 kg (5.51 lb)	–	–
3	223-1693	Hand Drilling (Short Handle) ⁽¹⁾	38.1	273 mm (10.75 in)	1.8 kg (4.01 lb)	–	
–	223-1695	Dead Blow Sledge	82.6	914.4 mm (36 in)	5.4 kg (12.02 lb)	–	–
–	223-1698	Double Face Sledge	54	905 mm (35.63 in)	5 kg (10.91 lb)	–	
–	245-9823	Double Face Sledge ⁽³⁾	73	914 mm (35.98 in)	7.2 kg (15.98 lb)	–	
Hammer Handles							
–	263-3821	–	–	–	–	762 mm (30 in) ⁽³⁾	Hickory
–	263-3822	–	–	–	–	915 mm (36.02 in) ⁽³⁾	Hickory

1 Warranty: Six Months

2 Warranty: Manufacturer: 120 Day

3 Warranty: Manufacturer, 120 Day

Handled Tooth Pin Removers



Warranty: Caterpillar Standard Warranty, 6 Months

- Removes and installs bucket teeth retaining pins
- Small enough to store in toolbox
- Quicker, safer, and easier than a conventional punch

Part Number	Use
196-1168	Replacement Handle for 196-1331 and 203-4290
196-1331	J350, J400, J450, and J460 GET Tips
203-4290	J550 GET tip

Handheld Tooth Pin Removers



Warranty: Caterpillar Standard Warranty, 6 Months

- Removes and installs solid or flex pins from bucket teeth
- Small enough to store in toolbox
- Quicker, safer, and easier than a conventional punch

Part Number	Use
143-2459	J200 and J225 GET Tips
143-2460	J250, J300, and J350 GET Tips
207-0631	23 Series Teeth and Diagonal Retention System (DRS)

Chisels and Punches

Pin Punch Set, 7 Piece - 226-1900



Warranty: Caterpillar Standard Warranty, 6 Months

- Replaces discontinued 1U-7250 Pin Punch Set, 7 Piece
- Individually heat treated for uniform hardness
- Includes pouch

Part Number	Point Size	Length	Description
226-1900	—	—	Pin Punch Set
Pin Punch Set Consists of:			
226-1901	1/16 in	102 mm (4.0 in)	Drive Pin Punch (3/32 in)
226-1902	3/32 in	114 mm (4.5 in)	Punch
226-1903	1/8 in	121 mm (4.75 in)	Punch
226-1904	5/32 in	152 mm (6 in)	Punch
226-1905	3/16 in	127 mm (5 in)	Punch
226-1906	7/32 in	146 mm (5.75 in)	Punch
226-1907	1/4 in	146 mm (5.75 in)	Punch

Drift Punch Set, 5 Piece - 227-3129



Warranty: Caterpillar Standard Warranty, 6 Months

- Replaces discontinued 1U-7260 Drift Punch Set, 5 Piece
- Material: high carbon steel
- Individually heat treated for uniform hardness
- Includes pouch

Part Number	Point Size	Length	Description
227-3129	—	—	Drift Punch Set
Drift Punch Set Consists of:			
227-3130	1/8 in	203 mm (8 in)	Punch
227-3131	3/16 in	254 mm (10 in)	Punch
227-3132	7/32 in	305 mm (12.0 in)	Punch
227-3133	1/4 in	305 mm (12.0 in)	Punch
227-3134	5/16 in	305 mm (12.0 in)	Punch

Chisel Group, 5 Piece - 227-3795

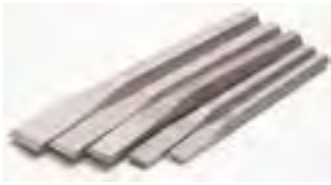

Warranty: Caterpillar Standard Warranty, 6 Months

- Individually heat-treated for uniform hardness
- Resharpener and polished after blasting for a sharper cutting edge
- Includes pouch

Part Number	Punch Size	Length	Description
227-3795	—	—	Chisel Group
Chisel Group Consists of:			
227-3796	5/16 in	127 mm (5 in)	Chisel
227-3797	3/8 in	140 mm (5.5 in)	Chisel
227-3798	7/16 in	152 mm (6 in)	Chisel
227-3799	1/2 in	152 mm (6 in)	Chisel
227-3800	5/8 in	165 mm (6.5 in)	Chisel

Individual Chisels and Punch Pieces



Warranty: Lifetime unless otherwise noted

- Hot-formed from fine alloy steel and heat treated for maximum hardness — they hold their edges and points

Item	Part Number	Punch Size	Length	Type
—	165-3977	4.95 mm ⁽¹⁾	154 mm (6.06 in)	Radius Punch
—	452-9936	13/32 in	139.7 mm (5.50 in)	Cold Chisel
—	1U-7296	3/16 in ⁽¹⁾	158.8 mm (6.25 in)	Center Punch
—	452-9937	5/32 in	203.2 mm (8.00 in)	Punch
—	8T-0832	1/4 in	142.7 mm (5.63 in)	Cape Chisel
1	8H-8578	3/8 in	241.3 mm (9.50 in)	Punch
2	452-9933	3/4 in	177.8 mm (7.00 in)	Cold Chisel
3	452-9934	3/16 in	152.4 mm (6.00 in)	Center Punch

¹ Warranty: Six Months

Pry Bars

Pry Bars

Warranty: Caterpillar Standard Warranty, 6 Months



Part Number	Description	Size
194-3553	Rolling Head Pry Bar	304.8 mm (12.00 in)
194-3556	Rolling Head Pry Bar	533.4 mm (21.00 in)
1U-7587	Pry Bar, 6 in long ⁽¹⁾	152.4 mm (6.00 in)
1U-7591	Pry Bar	457.2 mm (18.00 in)
1U-7592	Pry Bar	609.6 mm (24.00 in)
1U-7593	Pry Bar	762.0 mm (30.00 in)
4C-5647	Long Pry Bar	1371.6 mm (54.00 in)
4C-5742	Pry Bar	1168.4 mm (46.00 in)
5F-4764	Rolling Head Pry Bar, 40.64 cm (16 in)	406.4 mm (16.00 in)
386-3305	Extra long (6 ft) pry bar (Fiberglass and Iron)	1842 mm (72.5 in)

Bead Braker Bar - 4F-5166



Warranty: Caterpillar Standard Warranty, 6 Months

- Used to break frozen or rusted beads
- Lightweight and portable
- 30 inches (762 mm)
- 7/8 inch stock

Part Number	Description
4F-5166	Bead Braker Bar

Pry Bar Display - 244-0910



Warranty: Caterpillar Standard Warranty, 6 Months

- Eye-catching addition to the sales floor area
- Sturdy display measures only 406.4 mm x 457.2 mm (16 in x 18 in) at the base but it's 1625.6 mm (64 in) high for extra visual impact
- Display holds two 1U-7593, two 4C-5742, and one 4C-5647 pry bars.
- Pry bars purchased separately

Part Number	Description	Size
244-0910	Pry Bar Display	406.4 mm x 457.2 mm (16 in x 18 in) at the base; 1625.6 mm (64 in) high

¹ Warranty: Lifetime

Handled Pry Bars



Warranty: Caterpillar Standard Warranty, 6 Months

- Black chrome striking cap—hit bar without damage to handle
- Available in bar shank lengths of 30, 46, 61, and 91 cm (12, 18, 24, and 36 in)
- Ergonomic handle made from a dual durometer composite for user comfort; reduces hand fatigue
- Polished tip with black oxide finish
- Long-life finish resists rust and wear during use

Part Number	Description	Size
239-4140	Handled Pry Bar Kit includes: 239-4141, 239-4142, and 239-4143	—
239-4141	Handled Pry Bar	12 inch Handled Pry Bar, 30 cm (12 in)
239-4142	Handled Pry Bar	18 inch Handled Pry Bar, 46 cm (18 in)
239-4143	Handled Pry Bar	24 inch Handled Pry Bar, 61 cm (24 in)
239-4255	Handled Pry Bar	36 inch Handled Pry Bar, 91 cm (36 in)

Handled Pry Bar - 160-5119



Warranty: Caterpillar Standard Warranty, 6 Months

- 12" handled pry bar
- Blade extends through handle to deliver hammering force to the blade tip
- A metal end cap prevents damage to the handle
- Heated treated and precision forged steel
- Square blade
- 5/8" wide tip

Part Number	Description
160-5119	Handled Pry Bar

Miscellaneous Hand Tools — Knives, Saws and Cutting Tools

3-inch Stainless Steel Lockback - 429-0608



Warranty: Caterpillar Lifetime Warranty

- 1 7/8-inch (4.76 cm) blade
- 420 high carbon stainless steel
- Nail mark
- Polished stainless steel handle
- Lockback
- Cat branded
- Made in the USA

Specifications	
Overall Length	1.8 oz (51g)
Overall Length	5 1/4- inch (13 cm)

Part Number	Description
429-0608	3-inch Stainless Steel Lockback

5-inch Textured Stainless Steel Lockback - 429-0610



Warranty: Caterpillar Lifetime Warranty

- 3 1/4-inch (8.2 cm) blade
- 420 high carbon stainless steel
- Half-serrated
- Nail mark
- Textured stainless steel handle
- Brass rivets
- Lockback
- Cat branded
- Leather-accented pouch
- Made in USA

Specifications	
Weight	6.7 oz (190 g)
Overall Length	8-3/4 inch (22.2 cm)

Part Number	Description
429-0610	5-inch Textured Stainless Steel Lockback

Miscellaneous Hand Tools — Knives, Saws and Cutting Tools

5-inch Heavy-Duty Wood and Brass Lockback - 429-0611



Warranty: Caterpillar Lifetime Warranty

- 3 1/4-inch (8.2 cm) blade
- 420 high carbon stainless steel
- Nail mark
- Wood handle with brass bolsters
- Lockback
- Cat branded
- Leather pouch
- Made in USA

Specifications	
Weight	6.1 oz (173g)
Overall Length	8-½ inch (21.5 cm)

Part Number	Description
429-0611	5-inch Heavy-Duty Wood and Brass Lockback

5-inch Wood Inset Liner Lock - 429-0612



Warranty: Caterpillar Lifetime Warranty

- 3 1/4-inch (8.2 cm) blade
- Titanium carbo-nitrate coated 420 Stainless Steel
- Thumb stud for easy opening
- Steel handle with inset wood
- Liner lock
- Belt clip
- Lanyard mount
- Cat branded
- Made in USA

Specifications	
Weight	6.2 oz (175.7 g)
Overall Length	7 ¾ inch (19.6 cm)

Part Number	Description
429-0612	5-inch Wood Inset Liner Lock

Miscellaneous Hand Tools — Knives, Saws and Cutting Tools

5-inch G10 Liner Lock - 429-0613 and 429-0614



Warranty: Caterpillar Lifetime Warranty

- 3 1/4-inch (8.2 cm) blade
- Titanium carbo nitrate coated 420 Stainless Steel
- Thumb stud for easy opening
- Steel handle with inset wood
- Liner lock
- Belt clip
- Lanyard mount
- Cat branded
- Made in USA

Specifications	
Weight	6.2 oz (175.7g)
Overall Length	7-3/4 inch (19.6 cm)

Part Number	Description
429-0613	5-inch G10 Liner Lock with Thumbstud
429-0614	5-inch G10 Liner Lock with Nailmark

17-Function Multi-tool - 429-0609



Warranty: Caterpillar Lifetime Warranty

- 3 1/4 (8.2cm) blade
- File – fine/course
- Saw
- Serrated rope blade
- Can opener
- Bottle cap opener
- Blunt nose pliers/grippers/cutters
- English/metric ruler
- Philips bit – small, large
- Slotted bit – small, large
- 1/4-inch drive socket adapter
- 420 high carbon stainless steel
- Nail mark
- L-channel lock holds all blades in place
- Cat branded
- Leather-accented pouch
- Made in USA

Miscellaneous Hand Tools — Knives, Saws and Cutting Tools

17-Function Multi-tool - 429-0609 (Cont'd.)

Specifications	
Weight	9.1 oz (258g)
Overall Length	5 ¾-inch (14.6 cm)
Part Number	Description
429-0609	17-Function Multi-tool

3 3/4-inch Two-Blade Electricians Knife - 429-0615



Warranty: Caterpillar Lifetime Warranty

- 2 1/2-inch 420 high carbon stainless steel spear blade
- 2 3/8-inch 1095 carbon steel screwdriver/insulation cutter/wirescraper blade
- Delrin handle
- Nail mark
- Shackle
- Made in the USA

Specifications	
Weight	4.1 oz (116 g)
Overall Length	6-1/2 inch (16.5 cm)
Part Number	Description
429-0615	3 3/4-inch Two-Blade Electricians Knife

Utility Knife - 429-0616



Warranty: Caterpillar Lifetime Warranty

- Folding razor blade
- Safety-locking blade
- Quick change blade
- Uses standard two-notch replacement blades
- Nail mark
- Belt clip
- Cat branded

Part Number	Description	Size	Quantity
429-0616	Utility Knife	—	1
4C-4871	Utility Knife Blades	.635 mm (0.025 in)	100 blades per box

Miscellaneous Hand Tools — Knives, Saws and Cutting Tools

Utility Knife Blades

Warranty: Caterpillar Standard Warranty, 6 Months

- 0.635 mm (0.025 in)

Part Number	Description	Qty.
4C-4871	Utility Knife Blades	100 blades per box

Single Edge Razor Blades



- Industrial quality
- Ideal for scraping paint and glass, cutting, and trimming
- Fits all standard razor blade tools
- Gauge: 0.009

Part Number	Qty.
264-4353	100 per carton

Hacksaws



Warranty: Lifetime unless otherwise noted

Part Number	Description	Length	Use	Teeth	Material	Qty.
194-3552	Hacksaw	350.0 mm (13.78 in)	for use with 12 inch blade; blade tensioning device in handle	—	—	—
208-6183	Hacksaw	419.1 mm (16.50 in)	for use with 12 inch blade	—	—	—
Replacement Hacksaw Blade Sets						
1U-9234	Replacement Hacksaw Blade Sets	305.0 mm (12 in)	—	457 mm (18 in)	Bi-Metal	5
1U-9236	Replacement Hacksaw Blade Sets	305.0 mm (12 in)	—	610 mm (24 in)	Bi-Metal	10
1U-9238	Replacement Hacksaw Blade Sets	305.0 mm (12 in)	—	813 mm (32 in)	Bi-Metal	5

Miscellaneous Hand Tools — Knives, Saws and Cutting Tools

File Set, 8 piece



Warranty: Manufacturer, 120 Day

- Files meet Federal Specification #GGG-F-325B
- Manufactured under ISO 9002 Certification
- Files and wood file handles can be ordered separately
- Material: high carbon steel

Part Number	Description
264-0414	8 piece File Set
264-0414 consists of	
263-9067	Aluminum File, 254 mm (10 in)
263-9069	Half Round Bastard File, 254 mm (10 in)
263-9070	Mill Bastard File, 203.2 mm (8 in)
263-9071	Round File, 4.8 mm (3/16) diameter x 203.2 mm (8 in) long
263-9072	Slim Taper File, 152.4 mm (6 in)
263-9074	Mill Bastard File, 152.4 mm (6 in)
263-9075	Wood File Handle for file lengths between 152.4 mm (6 in) to 203.2 mm (8 in)
263-9076	Wood File Handle for file lengths between 203.2 mm (8 in) to 254 mm (10 in)

Filter Cutter - 175-7546

Warranty: Caterpillar Standard Warranty, 6 Months

- Used to cut open spin-on filters to inspect filter media for contaminants, a common practice when diagnosing potential machine problems and internal contaminants.
- Aluminum frame construction
- Designed to cut all types of filters, including aircraft-style filters, without repositioning cutting wheels
- Heavy-duty double roller and cutting wheel design eliminates binding of filters
- All wear parts are heat-treated steel for added durability
- Cutting wheels are ground with a double-taper edge for easier cutting

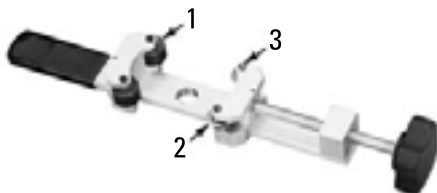

Item	Part Number	Description	Required
—	175-7546	Oil Filter Cutter Group	—
Replacement Parts			
1	177-0364	Roller	2
2	177-0365	Cutting Wheel	2
3	177-0367	Pin	4
Not shown	177-0366	Spacer	2

Miscellaneous Hand Tools — Knives, Saws and Cutting Tools

Quick Release Tubing Cutters



Warranty: Lifetime except part 4C-6979

- Offer the best tracking and easiest cutting available anywhere
- Cut copper, aluminum and steel tubing (not steel pipe)
- With a quick wheel change, they also cut a wide variety of plastic pipe and tubing

Item	Part Number	O.D. Capacity	Length	Weight	Wheel for Copper, Aluminum, Brass, Steel	Wheel for Stainless Steel
1	4C-6977	3.0 mm - 33.0 mm (.13 in - 1.31 in)	152 mm (5.98 in)	0.2 kg (0.44 lb)	4C-6980	4C-6981
2	4C-6978	6.0 mm - 60.0 mm (.25 in - 2.63 in)	203 mm (7.99 in)	0.5 kg (1.10 lb)	4C-6980	4C-6981
3	4C-6979	10.0 mm - 90.0 mm (.38 in - 3.50 in) ⁽¹⁾	279 mm (10.98 in)	1.1 kg (2.43 lb)	4C-6982	—

¹ Warranty: Six Months

Miscellaneous Hand Tools — Levels, Measuring Tools and Gauges

Universal Level - 9U-7329



Warranty: Caterpillar Standard Warranty, 6 Months

- Made of high-impact ABS
- Has two easy-to-read Plexiglas vials, one a vertical angle dial adjustable from 0° to 180°

Part Number	Description
9U-7329	Universal Level

Protractor - 441-3703



Warranty: Caterpillar Standard Warranty, 6 months

- Quickly find angles
- Determine miter angle layout
- Measure and transfer inside/outside sloped angles
- 6 inches (15 cm) long
- High-strength plastic with brass hardware

Part Number	Description
441-3703	Protractor

Tape Measures



Warranty: Caterpillar Standard Warranty, 6 Months

5P-3277, 1U-9366, 1U-9367, and 1U-9368

- 2-color
 - Handsome, chrome-finished case
 - Removable belt clip
 - Auto retract
 - Tape lock lever
- 232-5041**
- Ergonomically designed
 - Magnetic tip holds tape in place and makes long distance measuring much easier
 - Yellow and black plastic
 - Auto retract
 - Tape lock lever

Part Number	Blade Width	Blade Length	English Graduations	Metric Graduations	Locking Feature
1U-9366	19.0 mm (3/4 in)	16 ft (5 m)	1 in, 1/16 in	1.0 cm, 1.0 mm	Yes
1U-9367	25.4 mm (1 in)	26 ft (8 m)	1 in, 1/16 in	1.0 cm, 1.0 mm	Yes
1U-9368	25.4 mm (1 in)	30 ft (9 m)	1 ft, 1 in, 1/16 in	–	Yes

Miscellaneous Hand Tools — Levels, Measuring Tools and Gauges

Tape Measures (Cont'd.)

Part Number	Blade Width	Blade Length	English Graduations	Metric Graduations	Locking Feature
232-5041	25.4 mm (1 in)	26 ft (8 m)	1 ft, 1 in, 1/16 in	1.0 cm, 1.0 mm	Yes
5P-3277	12.7 mm (1/2 in)	10 ft (3 m)	1 in, 1/10 in	1.0 cm, 1.0 mm	Yes

Angle Finder and Level



Warranty: Caterpillar Standard Warranty, 6 months

- Quickly identifies angles without interference from cold, heat, or magnetic fields
- Demarked 0 to 90 degrees in five quadrants
- Ceramic magnetic base

Angle Finder and Level	437-4620
------------------------	----------

Tape Measures



Warranty: Caterpillar Standard Warranty, 6 Months

9U-7326 Tape Measure, 1/4 inch x 6 ft

- Black ABS-encased steel tape
- Slim and contemporary—fits easily in your pocket
- Has auto stop and return
- Readings in mm and inches

9U-7327 Tape Measure, 1/2 inch x 10 ft

- Can read dimensions directly on the tape by looking in a see-through window
- Great for inside measurements such as window dimensions
- Readings in mm and inches

Part Number	Description	Size
9U-7326	Pocket Tape	1/4 in x 6 ft
9U-7327	Tape Measure	1/2 in x 10 ft

Miscellaneous Hand Tools — Levels, Measuring Tools and Gauges

Steel Tape Measure



Warranty: Caterpillar Standard Warranty, 6 Months

- Heavy-duty vinyl covered welded steel case
- Yellow coated 3/8 inch wide blade, 2-color markings, folded steel hook, folding handle
- Graduation — inches in black, feet and 16 inch centers in red; meters in black, centimeters and millimeters in red
- English on one side, metric on the other side

Part Number	Blade Width	Blade Length	English Graduations	Metric Graduations
1U-9369	3/8 in	50	1 ft 1 in, 1/16 in	1.0 m, 1.0 cm, 1.0 mm

1000 mm Straight Edge - 386-3364

Warranty: Caterpillar Standard Warranty, Six months



- 1000 mm dual scale: 1/2 mm and 1 mm increments
- 40 inch dual scale: 1/32 and 1/64
- Graduation type 36
- Satin chrome finish with black markings

Part Number	386-3364
-------------	----------

Taper Gauge - 4C-8733



Warranty: Caterpillar Standard Warranty, 6 Months

- Used to quickly and conveniently measure openings for shim packs or spacers
- Used in place of thickness gauges
- Made of quality tool steel
- One side graduated in inches, other side in millimeters

Part Number	Description	Size
4C-8733	Taper Gauge	6.20 in x .40 in (160.0 mm x 11.0 mm)

Miscellaneous Hand Tools — Levels, Measuring Tools and Gauges

Block Magnet - 4C-9798



Warranty: Caterpillar Standard Warranty, 6 Months

- Measures or checks for straight line dimensions on any large, steel structure using magnet restrained string lines
- Fast, economical means of simplifying inspection of large steel structures for alignment, position, parallelism, dimensional accuracy
- Strong enough to hold a tight string over a steel structure
- Magnets can be stacked to obtain string clearance with structure features
- String not included

Part Number	Description	Size	Weight
4C-9798	Block Magnet	25.0 mm x 25.0 mm x 50.0 mm (1.00 in x 1.00 in x 2.00 in)	0.166 kg (0.366 lbs)

O-Ring Measuring Cone - 9U-5155



Warranty: Manufacturer, 30 Day

Find the correct O-ring replacement faster and easier.

- Designed to measure SAE industry standard O-ring dimensions (cross section and dash size). These dimensions are published by the Society of Automotive Engineers (SAE).
- 457.2 mm (18 in) tall, cone shaped
- Material: high-impact, yellow plastic
- Round base with five industry standard O-ring cross section diameters (widths) cut into the edge
- Cone has 65 steps indicating varying inside diameters

Part Number	Description
9U-5155	O-Ring Measuring Cone

Check-A-Thread



Warranty: Caterpillar Standard Warranty, 6 months

- Quickly identify the most common size nuts and bolts
- Female threaded holes to identify common bolt sizes
- Male threaded studs to identify nut sizes.
- Mounts to the wall or sits on its built in stand

Measure	Check-A-Thread Part Number
Inch	250-6865
Metric	250-6866

Miscellaneous Hand Tools — Levels, Measuring Tools and Gauges

Feeler Gauges



Warranty: Lifetime

Part Number	Description	Size
1U-7234	Feeler Gauge ⁽¹⁾	25 Blade, .0015 in - .040 in
386-3236	Feeler Stock Assortment	32 Blade, .0005 in - .030 in
8H-8581	Feeler Gauge	25 Blade, .0015 in - .025 in

Dual Scale Feeler Gauge Set, 13 Blade - 383-8887



Warranty: Caterpillar Lifetime

- Stamped with both Metric and English sizes
- English sizes: 0.001, 0.0015, 0.002, 0.003, 0.004, 0.005, 0.006, 0.007, 0.008, 0.010, 0.012, 0.013, 0.015 inch
- Metric sizes: 0.0254, 0.0381, 0.0508, 0.0762, 0.1016, 0.127, 0.1524, 0.1778, 0.2032, 0.254, 0.3048, 0.3302, 0.3381 mm

Part Number	Description
383-8887	Dual Scale Feeler Gauge Set

Plastic Gauges for Checking Clearance

SMCS Code: 1000-082, 0700, 0701, 0714

Models: All Engines or Clearance Between Any Mating Parts

Warranty: Caterpillar Standard Warranty, 6 Months

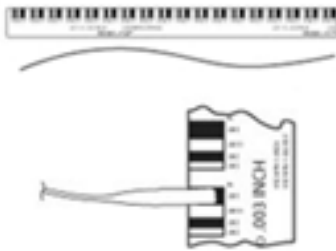

- Used to quickly and easily check clearance between mating parts (main rod and bearing clearance, component side clearance, oil pump cover to gear clearance, etc.)
- Plastigage clearance indicator is an extruded plastic thread that crushes when clamped between two mating parts
- Available in four color-coded sizes for easy identification
- Clearance thickness is determined by holding crushed indicator material against paper packaging (refer to illustration)
- Any plastic residue on parts can be quickly removed with component cleaner
- One indicator per package
- Overall length: 30.0 cm (12.00 in)

Part Number	Color	Clearance Range
198-9142	Green	0.025 to 0.076 mm (.001 to .003 in)
198-9143	Red	0.051 to 0.152 mm (.002 to .006 in)
198-9144	Blue	0.102 to 0.229 mm (.004 to .009 in)
198-9145	Yellow	0.230 to 0.510 mm (.009 to .020 in)

¹ Warranty: Six Months

Miscellaneous Hand Tools — Levels, Measuring Tools and Gauges

Hardness Tester - 6V-6035



Warranty: Caterpillar Standard Warranty, 6 Months

- Check crankshaft journal hardness
- Hardened steel ball strikes tested surface without damage
- 15 to 65 Rockwell C Scale
- Height of bounce read as Shore scleroscope reading

Reference

SEBF8041 Guideline for Reusable Parts

Part Number	Description
6V-6035	Hardness Tester

Thread Pitch Gauges



Warranty: Caterpillar Standard Warranty, 6 Months

- Quickly measure the pitch or lead of a bolt thread

Part Number	Description	Size
386-3235	Metric	18 Leaves, 0.4 mm - 7.0 mm
386-3237	English	30 Leaves, 4 - 42 TPI (Threads Per Inch)

Miscellaneous Hand Tools — Seal Picks

Seal Pick - 5P-1720



Warranty: Caterpillar Standard Warranty, 6 Months

- Used to remove and install all types of oil seals
- One end of pick is pointed for prying out flexible seals
- Blunt, hook end is used to align seals for installation and to eliminate the twist that occurs when installing O-ring or quad-ring seals
- Both ends of the pick are hardened and provide much greater strength than would normally be expected from a tool this size

Part Number	Description
5P-1720	Seal Pick

Seal Pick Kit - 5P-7414



Warranty: Lifetime

Part Number	Description
5P-7414	Seal Pick Kit

Seal Pick - 195-4609



Model: All Hydraulic Cylinders

Warranty: Lifetime

- Used to remove cylinder rod seals
- Large size allows faster and easier removal of seals from large hydraulic cylinders
- Heavy-duty design

Part Number	Description	Length
195-4609	Seal Pick	262 mm (10 in)

Miscellaneous Hand Tools — Brushes

Scratch Brushes



Warranty: Caterpillar Standard Warranty, 6 Months

- Hand scratch brushes are excellent for removing rust, scale, old paint, chips and dirt, and for cleaning castings and metal parts
- Provide long, effective service at extremely low cost

Part Number	Description	Size
1U-9915	Curved Handle Brush	.014 in (3 x 19 Row)
1U-9916	Curved Handle Brush	.012 in (4 x 19 Row)
1U-9917	Shoe Handle Brush	.014 in (4 x 16 Row)
1U-9918	Inspection Stainless Brush	.006 in (3 x 7 Row)

Corner Cleaner Wire Brush - 160-0774



Warranty: Caterpillar Standard Warranty, 6 Months

- Quickly removes flaking paint, rust, and scale
- Handy small size with pointed end works well in hard to reach areas
- Full size handle with finger grips and thumb rest provides added control and comfort
- Made of tough polypropylene

Part Number	Description	Overall Length
160-0774	Corner Cleaner Wire Brush	254.0 mm (10.00 in)

Longneck Wire Brush - 160-0772



Warranty: Caterpillar Standard Warranty, 6 Months

- Excellent for removing rust, scale, old paint, chips, or dirt
- Unique wrap-around handle protects your fingers
- Full size handle and molded finger grips add control and reduce fatigue
- Over 80 yards of wire for maximum performance
- Made of tough polypropylene
- Heavy-duty steel scraper has a baked-on, rust resistant finish
- Scraper is permanently secured to brush

Part Number	Description	Width	Overall Length
160-0772	Longneck Wire Brush	76.2 mm (3.00 in)	330.2 mm (13.00 in)

Miscellaneous Hand Tools — Brushes

Industrial Wire Scrubber - 160-0775



Warranty: Caterpillar Standard Warranty, 6 Months

- Quickly removes flaking paint, rust, and scale
- Dual grip design reduces fatigue — grasp either the handle or specially molded block
- Made of tough polypropylene

Part Number	Description	Overall Length
160-0775	Industrial Wire Scrubber	177.8 mm (7.00 in)

Parts Cleaning Brushes



Warranty: Caterpillar Standard Warranty, 6 Months

Item	Part Number	Description	Wire Size	Wire Row
1	1U-9920	11 in O.A.L.	Size #10	Black Polypropylene
2	1U-9919	11 in O.A.L.	Size #10	Tampico
3	2B-4317	10 3/4 in O.A.L.	Paint Style 1 1/2 in	Black Nylon

Paint Brushes



Warranty: Manufacturer, 120 Day

- Use with interior or exterior paints, stains, varnishes, and urethanes
- Quantity: one box of 12 brushes
- 262-9752 not available in Australia, New Zealand, Republic of Fiji or Papua New Guinea

Part Number	Width x Length	Material
262-9749	25 mm x 178 mm (1 in x 7 in)	Nylon Brush, Metal Ferrule, Plastic Handle
262-9750	51 mm x 203 mm (2 in x 8 in)	Nylon Brush, Metal Ferrule, Plastic Handle
262-9752	76 mm x 203 mm (3 in x 8 in)	Hog Bristle Brush, Metal Ferrule, Wood Handle

Acid Brushes



Warranty: Caterpillar Standard Warranty, 6 Months

- Genuine horsehair bristles, crimped with flat tin handle
- Chemical resistant handle

Part Number	Description	Size
1U-9977	Acid Brush	3/8 in
1U-9978	Acid Brush	1/2 in

Miscellaneous Hand Tools — Brushes

Battery Post Brush - 1U-9921



Warranty: Caterpillar Standard Warranty, 6 Months

- Stiff wire bristles thoroughly clean posts

Part Number	Description
1U-9921	Battery Post Brush

Miscellaneous Hand Tools — Miscellaneous

Rivet Sets



Warranty: Caterpillar Standard Warranty, 6 Months

- Available for either "Star" set rivets or "Roll" set rivets
- "Star" set rivets, identified by a star stamped in the head, should be used only where the clinching is done against a non-metallic surface. To form a good clinch, there should be approximately 3/16 inch of rivet extension before the rivet is set.
- "Roll" set rivets, marked with a circle on the head, should be used when clinching is done against metal. To form a good clinch, there should be approximately 1/8 inch of rivet extension before the rivet is set.

Item	Part Number	Description
–	6V-7013	Roll Set (for 5/32 in rivets)
1	1P-2874	Roll Set (for 1/4 in rivets)
2	6F-6947	Star Set
3	6F-6946	Roll Set (for 3/16 in rivets)

Riveter Kit - 129-1063



SMCS Code: 4054

Model: M312 Wheeled Excavators

Warranty: Lifetime

- Used for miscellaneous repairs requiring rivets
- Comes with three different nose pieces

Part Number	Description	Length
129-1063	Riveter Set	53.0 cm (21.0 in)

Shovels and Spades

Warranty: Manufacturer, Lifetime

- Ergonomically engineered for balance and safety
- Latest technology fiberglass handles
- Super-duty, pultruded core with reinforcement sections adds strength
- Molded-exterior, polymer clad jacket for handling comfort



Item	Part Number	Description
1	157-2264	Shovel, Round Point with 122 cm (48 in) long handle
2	157-2276	Spade, Drain with 122 cm (48 in) long handle
3	157-2268	Shovel, Square with 122 cm (48 in) long handle
4	157-2273	Scoop, # 12 Aluminum
5	157-2278	Spade, Drain with 69 cm (27 in) D handle
6	157-2269	Shovel, Square Point with 69 cm (27 in) D handle
7	157-2266	Shovel, Round Point with 69 cm (27 in) D handle

Miscellaneous Hand Tools — Miscellaneous

Retrieval Tools

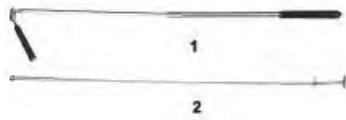

Warranty: Lifetime

Item	Part Number	Description
1	1U-7262	Magnet
2	146-2728	Flex Pickup Tool

Inspection Mirror



Warranty: Caterpillar Standard Warranty, 6 Months

- The mirror extends to 15 1/4 in long
- The mirror swivels 360 degrees

Part Number	Description
9U-6182	Inspection Mirror

Scraper



Warranty: Caterpillar Standard Warranty, 6 Months

Part Number	Description	Size
8H-8580	Scraper	38.1 mm (1.50 in) wide

Filter and Plug Removal and Installation Tools



Warranty: Lifetime unless otherwise noted

- Used to remove and install drain and fill plugs
- Most hexagonal plugs can also be removed and installed using the 213-1985 Sliding T-Handle and 8H-8561 Socket

Item	Part Number	Description
1	1S-2475	Wrench, 3/4 in square ⁽¹⁾
2	8H-8559	Socket Extension
3	213-1985	Sliding T-Handle
4	212-8145	Drain Plug Socket ⁽¹⁾
5	212-8146	Drain Plug Socket, 1/2 in Female, 1 in and 1 1/2 in Hex ⁽¹⁾
6	185-3630	Filter Strap Wrench Assm. ⁽¹⁾

¹ Warranty: Six Months

Miscellaneous Hand Tools — Miscellaneous

Cab Glass Installation Tools



Warranty: Caterpillar Standard Warranty, 6 Months

- For installing the filler strips around the glass in cabs

Part Number	Description
4C-9946	Filler Strip Tool Assembly
5H-4845	Seal Installation Tool Assembly

Superior E-Z Thrust Caulker



Warranty: Caterpillar Standard Warranty, 6 Months

- Holds any 12 oz. tube designed for use with a caulking gun
- Recommended for all grades of caulks, sealants and adhesives from heavy to light consistencies

Part Number	Description	Cartridge Size
4C-6922	E-Z Thrust Caulker	0.01 gal

Super Ratchet-Type Caulker



Warranty: Caterpillar Standard Warranty, 6 Months

- Designed for the professionals who prefer ratchet guns
- Will outlast, outperform all other ratchet guns
- Engineered to withstand heavy use
- Equipped with ladder hook, built-in spout cutter, seal puncture tool, and convenient "D" ring and wrist strap

Part Number	Description	Cartridge Size
4C-6923	Ratchet-Type Caulker	1/10 gal

BIM Saw Blades



Warranty: Manufacturer, 120 Day

Part Number	Length	Teeth	Package Quantity	Teeth Specs
1U-9234	305.0 mm (12 in)	457 mm (18 in)	5	Raker BIM ⁽²⁾
1U-9236	305.0 mm (12 in)	610 mm (24 in)	10	Wavy BIM
1U-9238	305.0 mm (12 in)	813 mm (32 in)	5	Wavy BIM

² BIM – All purpose blade, highly flexible, for the most difficult materials

Miscellaneous Hand Tools — Miscellaneous

Bi-Metal All-Purpose Tiger Saw Blades



Warranty: Caterpillar Standard Warranty, 6 Months

Part Number	Length	Teeth/Inch	Package Quantity	Recommended Use
4C-9942	152 mm (6 in), flexible	18	5	Heavy gauge (non-ferrous metals) — bar and angle stock-stainless-galvanized pipe-tubing (over 18 ga.)
4C-9943	152 mm (6 in), flexible	14	5	Heavy gauge (non-ferrous metals) — bar and angle stock-cast aluminum-copper-brass-galvanized
4C-9944	229 mm (9 in)	5/7	5	General roughing-in wood
4C-9945	305 mm (12 in)	6	5	General roughing-in wood

Terminal Tool Group - 435-5074



Warranty: Caterpillar Standard Warranty, 6 months

- Tools set for most domestic computer connectors and terminals
- Designed for weather pack and pack-con terminals with flat blade to open connectors and fork for ALDL connectors to access trouble codes
- Individual handles for easy access in tight spaces
- Storage case
- Kit includes:

GM C3 System Terminal Tools (red handle)	
Spring Loaded Tube	1/8 x 1 in (3.3 mm x 28 mm)
Square Blade	1/16 x 3/4 in (1.4 x 19 mm)
Flat Blade	1/16 x 1 in (1.5 x 24.75 mm)
Flat Blade	5/64 x 1 in (2 x 23 mm)
Fork Blade	5/16 x 1 in (8 x 24 mm)
Flat Blade Screwdriver	3/16 x 1 in (4.75 x 24 mm)

Wire Terminal Tools (green handle)	
Tube	1/8 x 1 in (3.3 x 28 mm)
Tube	11/64 x 1/2 in (4.3 x 13 mm)
Tube	5/32 x 1/2 in (3.75 x 13 mm)
Tube	1/8 x 1/2 in (3 x 13 mm)
Flat Twin Blade	1/8 in (3 mm)
Twin Blade	1/16 in (1.6 mm)

Part Number	Description
435-5074	Terminal Tool Group

Cat 55-Inch Tool Boxes



Warranty: Manufacturer, Lifetime

- Heavy-duty welded construction
- Full-length double walls
- Steel gusset reinforced corners
- Multiple applications of powder coat paint
- Soft, durable wheels reduce vibration and last a lifetime
- Two banks of drawers — 70/30 split
- Long-lasting ball bearing drawer slides
- Lock 'n Roll drawers keeps them secure during movement
- Each drawer holds up to 125 pounds
- Doubled over drawer edges make them smooth and rigid
- Deep, comfortable drawer pulls
- Top drawer of the roller cabinet is a full width drawer with two slides and four welded drawer supports to hold up to 250 pounds
- Bottom drawer of the roller cabinet has two slides to hold up to 250 pounds
- Upgraded drawer pads

55-Inch Top Chests

- 10 Drawers
- 1 Top Storage Compartment
- Dimensions: 55" W x 24" D x 21" H (140 cm W x 61 cm D x 53 cm H)
- Volume: 13,600 cubic inches (222,863 cm³)
- Surface Area: 4,000 square inches (65,548 cm²)
- Capacity: 1,400 lbs (635 kg)

55-Inch Roller Cabinets

- 11 Drawers
- Dimensions: 55" W x 24" D x 39" H (140 cm W x 61 cm D x 99 cm H)
- Volume: 25,000 cubic inches (409,675 cm³)
- Surface Area: 6,300 square inches (40,645 cm²)
- Capacity: 2,400 lbs (1,089 kg)

Part Number	Color
55-Inch Roller Cabinets	
385-1731	Black

Tool Boxes

Cat 40-Inch Tool Boxes



Warranty: Manufacturer, Lifetime

- Heavy-duty welded construction
- Full-length double walls
- Steel gusset reinforced corners
- Multiple applications of powder coat paint
- Long-lasting ball bearing drawer slides
- Lock 'n Roll drawers keeps them secure during movement
- Each drawer holds up to 100 pounds
- Doubled over drawer edges make them smooth and rigid
- Deep, comfortable drawer pulls
- Upgraded drawer pads
- Cat branded

40-Inch Top Chests

- 4 Drawers
- 1 Top Storage Compartment
- Dimensions: 40" W x 20" D x 19" H (101 cm W x 51 cm D x 50 cm H)
- Volume: 9,800 cubic inches (160,593 cm³)
- Surface Area: 3,200 square inches (20,645 cm²)
- Capacity: 1,400 lbs (635 kg)

40-Inch Roller Cabinets

- 7 Drawers
- Dimensions: 40" W x 20" D x 38" H (101 cm W x 51 cm D x 98 cm H)
- Volume: 15,000 cubic inches (245,805 cm³)
- Surface Area: 4,250 square inches (27,419 cm²)
- Capacity: 2,400 lbs (1,089 kg)

Part Number	Color
40-Inch Top Chests	
385-1726	Black
385-1728	Red
40-Inch Roller Cabinets	
385-1727	Black
385-1729	Red

Cat 26-Inch Tool Boxes



Warranty: Manufacturer, Lifetime

- Heavy-duty welded construction
- Full length double walls
- Steel gusset reinforced corners
- Multiple applications of powder coat paint
- Long-lasting ball bearing drawer slides
- Lock 'n Roll drawers keeps them secure during movement
- Each drawer holds up to 100 pounds
- Doubled over drawer edges make them smooth and rigid
- Deep, comfortable drawer pulls
- Upgraded drawer pads
- Cat branded

26-Inch Top Chests

- 4 Drawers
- 1 Top Storage Compartment
- Dimensions: 26" W x 20" D x 19" H (66 cm W x 51 cm D x 49 cm H)
- Volume: 6,200 cubic inches (101,599 cm³)
- Surface Area: 2,000 square inches (12,903 cm²)
- Capacity: 650 lbs (295 kg)

26-Inch Roller Cabinets

- 7 Drawers
- Dimensions: 26" W x 20" D x 37" H (66 cm W x 51 cm D x 94 cm H)
- Volume: 10,000 cubic inches (163,870 cm³)
- Surface Area: 2,400 square inches (15,484 cm²)
- Capacity: 1,100 lbs (499 kg)

Part Number	Color
26-Inch Top Chests	
385-1722	Black
385-1724	Red
26-Inch Roller Cabinets	
385-1723	Black
385-1725	Red

Tool Boxes

Drop Front Tool Chest - 329-6983



Warranty: Manufacturer, Lifetime

- Heavy-duty welded construction
- Full-length double walls
- Doubled over drawer edges make them smooth and rigid
- Ball bearing drawer slides
- Powder coat paint
- Round key lock
- Locking components welded securely inside box
- Drop down front lid for extra security
- Durable side handles
- Cat Branded

26-inch Drop Front Tool Chest

- 5 Drawers
- 1 Top Storage Compartment
- Dimensions: 26" W x 15" D x 17" H (66 cm W x 37 cm D x 44 cm H)
- Volume: 4,452 cubic inches (72,955 cm³)
- Surface Area: square inches 1,814 (11,703 cm²)
- Capacity: 650 pounds (295 kg)

Part Number	Description	Color
329-6983	Drop Front Tool Chest	Black

Cat Well Cabinet - 471-9317



Warranty: Manufactures, lifetime

- 18 gauge SRS steel
- Black power coat finish
- Built-in metal pegboard (1/4 hole diameter)
- Hardware assortment
- Mounted clasp for locking
- Doors lock open
- Dimensions (closed): 36" W x 9.75" D x 36" H (914 mm W x 248 mm D x 914 mm H)
- Dimensions (open): 72" W x 5.75" D x 36" H (1826 mm W x 146 mm D x 914 mm H)

Cat Multi-Purpose Roll Cart - 385-1737



Warranty: Manufacturer, Lifetime

- Multi-purpose roll cart
- Black
- Lockable Drawer
- 32" W x 18" D x 36" H (81 cm W x 46 cm D x 91 cm H)
- 3" (8 cm) deep tray
- 150 lbs (68 kg) load capacity per tray
- Weight capacity: 350 lbs (159 kg)
- Cat branded

Part Number	Description
385-1737	Cat Multi-Purpose Roll Cart

All-Purpose Roll Cart - 385-1738



Warranty: Manufacturer, Lifetime

- Rugged all-purpose cart
- Black
- Drain hole in top shelf
- 36" W x 24" D x 38" H (91 cm W x 61 cm D x 97 cm H)
- Weight capacity: 500 lbs (227 kg)

Part Number	Description
385-1738	All-Purpose Roll Cart

Tool Bag with Carrying Strap - 248-2283



Warranty: Caterpillar Standard Warranty, 6 Months

- Nine pockets and ten tool-holding loops on the outside
- Twelve pockets on the inside for holding additional tools

Part Number	Description	Length	Material
248-2283	Tool Bag with Carrying Strap	0.61 m (24 in)	Cloth

Tool Boxes

Cordura Cloth Tool Bag



Warranty: Caterpillar Standard Warranty, 6 Months

- Durable cloth tool bag made of Cordura fabric
- Cat Branded Tool bag

Part Number	Color	Size
211-0136	Black	610.0 mm x 203.0 mm x 159.0 mm (24.00 in x 8.00 in x 6.25 in)

Heavy Duty Plastic Tool Box - 329-6922



Warranty: Caterpillar Standard Warranty, 6 Months

- Heavy duty plastic tool box with tray
- Recessed handle
- Two steel latches
- Padlock eyes
- Yellow and black
- 23 in W x 10 1/2 in D x 10 in L

Part Number	Description
329-6922	Heavy Duty Plastic Tool Box

Tool Box - 9U-6219



Warranty: Manufacturer, Lifetime

- Black, steel construction
- Tote tray included

Part Number	Description	Length	Width	Height	Material
9U-6219	Tool Box	508 mm (20 in)	219.08 mm (8.63 in)	219.08 mm (8.63 in)	Steel

Lock - 174-9803



Warranty: Caterpillar Standard Warranty, 6 months

- Replacement Barrel Lock kit

Part Number	Description
174-9803	Lock with two keys

Lock Kit - 5P-4724



Warranty: Lifetime

- Replacement Flat Lock kit

Part Number	Description
5P-4724	Lock Kit

Metal Storage Boxes with Hinged Lids and Socket Trays

Warranty: Manufacturer, 90 Day

Part Number	Description	Length	Width	Height	Storage Capacity (in ³)	Color
5P-0946	Box	457.2 mm (18.0 in)	254.0 mm (10.0 in)	127.0 mm (5.0 in)	900.0	Orange
5S-6092	Tool Box	788.67 mm (31.06 in)	317.5 mm (22.5 in)	146.05 mm (5.75 in)	–	Red
9S-1725	Case	159.5 mm (6.28 in)	103.1 mm (4.06 in)	25.4 mm (1.0 in)	–	Red

Plastic Tool Box - 202-8643



Warranty: Manufacturer, 60 Day

- Plastic, water-tight container
- Will not rust or scratch

Part Number	Description	Dimension	Tool Box Capacity	Color
202-8643	Tool Box (plastic)	514.4 x 212.7 x 225.4 mm (20.25 x 8.37 x 8.87 in)	9 kg (20 lbs)	Gray

Case and Dividers



Warranty: Caterpillar Standard Warranty, 6 Months

- Used for organizing fastener groups and other small reusable items
- Convenient to transport to a field site due to compact size
- Overall case dimensions: 457 x 305 x 76 mm (18.0 x 12.0 x 3.0 in)
- Dividers can partition case to a maximum of 48 bins
- Dividers in packages of 12 each

Part Number	Description	Number of Compartments	Outside Dimensions
178-2212	Case	–	457 mm L x 305 mm W x 127 mm D (18 in L x 12 in W x 3 in D)
178-2213	Dividers	48 bins	–

Tool Boxes

Plastic Storage Cases with Hinged Lids

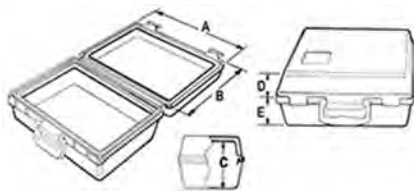

Warranty: Manufacturer, 60 Day

- Impact-resistant
- Textured surface to prevent scratches

Part Number	Length (A) (exterior, interior)	Length (B) (exterior, interior)	Length (C) (exterior, interior)	Depth (D) (exterior, interior)	Depth (E) (exterior, interior)	Handle Material	Number of Latches	Color
148-5675	216 mm (8.50 in), 192 mm (7.56 in)	198 mm (7.81 in), 149 mm (5.88 in)	90 mm (3.56 in), 83 mm (3.25 in)	20 mm (0.78 in), 17 mm (0.67 in)	70 mm (2.75 in), 66 mm (2.60 in)	No	One	Black
4C-3975	394 mm (15.50 in), 356 mm (14.00 in)	311 mm (12.25 in), 273 mm (10.75 in)	140 mm (5.50 in), 127 mm (5.00 in)	44 mm (1.75 in), 35 mm (1.38 in)	95 mm (3.75 in), 92 mm (3.63 in)	Yes	Two	Black
4C-4730	660mm (26.00 in), 622 mm (24.50 in)	421mm (16.56 in), 330 mm (13.00 in)	114 mm (4.50 in), 102 mm (4.00 in)	23 mm (0.90 in), 20 mm (0.78 in)	84 mm (3.31 in), 79 mm (3.12 in)	Yes	Two	Gray
6V-3072	394 mm (15.50 in), 356 mm (14.00 in)	311 mm (12.25 in), 273 mm (10.75 in)	102 mm (4.00 in), 89 mm (3.50 in)	25 mm (1.00 in), 16 mm (0.63 in)	76 mm (3.00 in), 73 mm (2.63 in)	Yes	Two	Black
6V-3073	311 mm (12.25 in), 289 mm (11.38 in)	224 mm (8.81 in), 178 mm (7.00 in)	99 mm (3.88 in), 90 mm (3.56 in)	30 mm (1.19 in), 24 mm (0.94 in)	68 mm (2.69 in), 65 mm (2.56 in)	Yes	Two	Black
6V-3112	254 mm (10.00 in), 238 mm (9.38 in)	191 mm (7.50 in), 170 mm (6.69 in)	30mm (1.18 in), 24 mm (0.94 in)	–	–	No	None	Black
6V-6045	191 mm (7.50 in), 173 mm (6.81 in)	102 mm (4.00 in), 81 mm (3.19 in)	41 mm (1.63 in), 33 mm (1.31 in)	10 mm(0.38 in), 3 mm (0.13 in)	31 mm (1.25 in), 30 mm (1.19 in)	No	One	Black
6V-7145	470 mm (18.50 in), 432 mm (17.00 in)	395 mm (15.56 in), 330 mm (13.00 in)	127 mm (5.00 in), 114 mm (4.50 in)	43 mm (1.70 in), 35 mm (1.38 in)	84 mm (3.31 in), 79 mm (3.12 in)	Yes	Two	Black
6V-9449	470 mm (18.50 in), 432 mm (17.00 in)	395 mm (15.56 in), 330 mm (13.00 in)	203 mm (8.00 in), 187 mm (7.38 in)	102 mm (4.00 in), 89 mm (3.50 in)	101 mm (3.96 in), 82.5 mm (3.25 in)	Yes	Two	Black
8T-0841	394 mm (15.50 in), 356 mm (14.00 in)	311 mm (12.25 in), 273 mm (10.75 in)	191 mm (7.50 in), 175 mm (6.88 in)	95 mm (3.75 in), 83 mm (3.27 in)	95 mm (3.75 in), 92 mm (3.63 in)	Yes	Two	Black

Foam Block for Plastic Storage Cases

Warranty: Caterpillar Standard Warranty, 6 Months

Part Number	Length	Width	Thickness	Material	Color	Convolted
148-5677	165 mm (6.5 in)	200 mm (7.9 in)	38 mm (1.5 in)	Etherfoam ⁽¹⁾	Charcoal	No
2P-8289	457.2 mm (18.0 in)	254 mm (10.0 in)	50.8 mm (2.0 in)	Esterfoam ⁽²⁾	Charcoal	Yes
3P-1549	386.08 mm (15.2 in)	279.4 mm (11.0 in)	12.7 mm (.05 in)	Ethafoam ⁽³⁾	Black	No
6V-4094	279.4 mm (11.0 in)	170.18 mm (6.7 in)	38.1 mm (1.5 in)	Esterfoam ⁽²⁾	Charcoal	Yes
6V-4873	360.68 mm (14.2 in)	279.4 mm (11.0 in)	12.7 mm (0.5 in)	Ethafoam ⁽³⁾	Black	No
6V-6044	353.06 mm (13.9 in)	264.16 mm (10.4 in)	25.4 mm (1.0 in)	Ethafoam ⁽³⁾	Black	No

- 1 Lightweight
- 2 General Purpose
- 3 Dense

Foam Block for Plastic Storage Cases (Cont'd.)

Part Number	Length	Width	Thickness	Material	Color	Convoluted
6V-6096	190.5 mm (7.5 in)	149.86 mm (5.9 in)	12.7 mm (0.5 in)	Ethafoam ⁽⁴⁾	Black	No
6V-6105	350.52 mm (13.8 in)	254 mm (10.0 in)	12.7 mm (0.5 in)	Etherfoam ⁽⁵⁾	Charcoal	No
6V-6107	190.5 mm (7.5 in)	149.86 mm (5.9 in)	27.94 mm (1.1 in)	Ethafoam ⁽⁴⁾	Black	No
6V-6126	365.76 mm (14.4 in)	276.86 mm (10.9 in)	73.7 mm (2.9 in)	Ethafoam ⁽⁴⁾	Black	No
8S-5128	520.7 mm (20.5 in)	223.52 mm (8.8 in)	50.8 mm (2.0 in)	Esterfoam ⁽⁶⁾	Charcoal	Yes
8T-3153	322.58 mm (12.7 in)	238.76 mm (9.4 in)	10.16 mm (0.4 in)	Ethafoam ⁽⁴⁾	Black	No
9S-8105	482.6 mm (19.0 in)	431.8 mm (14.0 in)	38.1 mm (1.5 in)	Ethafoam ⁽⁴⁾	Charcoal	Yes

Plastic Divided Utility Boxes with Hinged Lids

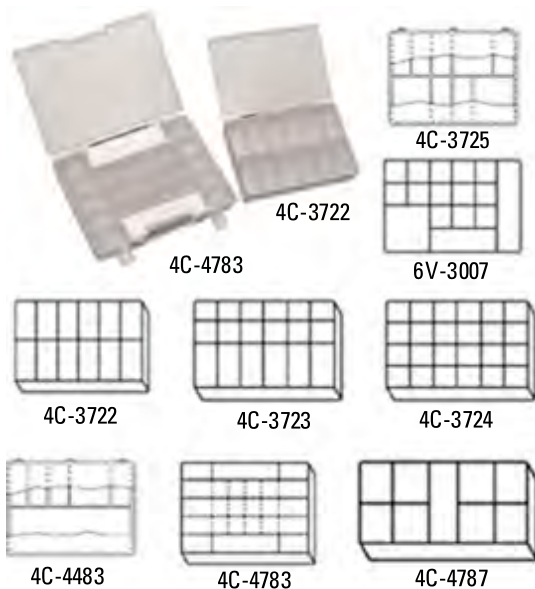

Warranty: Manufacturer, 60 Day

- Heavy-duty plastic boxes for organizing, storing, and protecting small parts
- Yellow polypropylene material—resistant to oils, solvents and common chemicals
- Rustproof, dentproof, spark proof, and non-conductive

Part Number	Length	Width	Thickness	Color	Number of Compartments	Size
152-7997	470.0 mm (18.5 in)	332 mm (13.07 in)	77 mm (3.03 in)	Yellow	21	—
4C-3722	332.74 mm (13.10 in)	228.60 mm (9.00 in)	58.42 mm (2.30 in)	Yellow	12	50.80 x 104.14 mm (2.00 x 4.10 in)
4C-3723	332.74 mm (13.10 in)	228.60 mm (9.00 in)	58.42 mm (2.30 in)	Yellow	6, 12	50.80 x 101.60 mm (2.00 x 4.10 in), 50.80 x 50.80 mm (2.00 x 2.00 in)
4C-3724	332.74 mm (13.10 in)	228.60 mm (9.00 in)	58.42 mm (2.30 in)	Yellow	24	50.80 x 50.80 mm (2.00 x 2.00 in)
4C-3725	332.74 mm (13.10 in)	228.60 mm (9.00 in)	58.42 mm (2.30 in)	Yellow	3, 6	104.14 x 104.14 mm (4.10 x 4.10 in), 50.80 x 104.14 mm (2.00 x 4.10 in)
4C-4463	332.74 mm (13.10 in)	228.60 mm (9.00 in)	58.42 mm (2.30 in)	Yellow	4, 1, 1	50.80 x 104.14 mm (2.00 x 4.10 in), 104.14 x 104.14 mm (4.10 x 4.10 in)

- 4 Dense
5 Lightweight
6 General Purpose

Tool Boxes

Plastic Divided Utility Boxes with Hinged Lids (Cont'd.)

Part Number	Length	Width	Thickness	Color	Number of Compartments	Size
						in), 104.14 x 317.50 mm (4.10 x 12.50 in)
4C-4783	381 mm (15.00 in)	298.5 mm (11.75 in)	63.50 mm (2.50 in)	Gray/See-through Smoke Gray	9-24	15 Removable Dividers
4C-4787	177.80 mm (7.00 in)	95.3 mm (3.75 in)	31.75 mm (1.25 in)	Opaque	8, 1	35.05 x 41.15 mm (1.38 x 1.62 in), 28.45 x 82.55 mm (1.12 x 3.25 in)
4C-4789	209.55 mm (8.25 in)	114.3 mm (8.66 in)	35.05 mm (1.38 in)	Opaque	12	31.75 x 50.80 mm (1.25 x 2.00 in)
6V-3007	332.74 mm (13.10 in) ⁽⁷⁾	220 mm (8.66 in)	58.42 mm (2.30 in)	Opaque	13, 1, 1, 1	50.80 x 50.80 mm (2.00 x 2.00 in), 50.80 x 158.75 mm (2.00 x 6.25 in), 50.80 x 212.85 mm (2.00 x 8.38 in), 104.65 x 104.65 mm (4.12 x 4.12 in)

Protector Cases - Pelican Line

Warranty: Manufacturer, Lifetime

- Make an excellent lockable storage vault when equipment is not in use - just apply a lock
- Strong, double-throw latches - easier to open with a light pull
- Watertight, airtight, dust proof - Pelican cases feature an exclusive 6.5 mm (1/4 in) neoprene "O" ring, to guarantee a perfect seal. Neither dust nor water can penetrate this barrier to harm your equipment. These cases are so airtight and watertight they float even when loaded. The "O" ring is easily replaced if damaged.
- Purge valve - The exclusive built-in "O" ring purge valve is sealed for pressure allowing for quick equalization after changes in altitude or temperature.
- Dentproof - The tough, cushioned, protective shell eliminates damage from bumping, jarring, and even airline shipments
- Protect contents inside - Multiple layers of industrial grade photographic foam secure and cushion equipment
- Custom fit for tooling - The "Pick-N'Pluck" center foam section is pre-scored for quick and clean custom fitting. The case lid is lined with the same convoluted foam for maximum shock protection
- Lightweight - easy to carry by using the comfortable, molded handle (4C-9650 and 4C-9658 have fold-down handles.)
- All cases are gray

⁷ Warranty: Six Months

Protector Cases - Pelican Line (Cont'd.)



Part Number	Description	Outside Length	Outside Width	Outside Depth	Inside Length	Inside Width	Inside Depth	Weight	Shipping Weight	Replacement Foam Set	Replacement O-Ring
4C-9650 ⁽⁸⁾	Pelican Mini S Case™ (Fold-down handle)	273 mm (10 3/4 in)	247.7 mm (9 3/4 in)	127 mm (5 in)	241 mm (9 1/2 in)	191 mm (7 1/2 in)	114 mm (4 1/2 in)	.91 kg (2 lb)	1.6 kg (3 lb)	4C-9651, 3 Pc.	4C-9739
4C-9652	Pelican Mini D Case™	273 mm (10 3/4 in)	247.7 mm (9 3/4 in)	177.8 mm (7 in)	241 mm (9 1/2 in)	191 mm (7 1/2 in)	165 mm (6 1/2 in)	1.13 kg (2 1/2 lb)	1.59 kg (3 1/2 lb)	4C-9653, 3 Pc.	—
4C-9654	Pelicase™	343 mm (13 1/2 in)	327 mm (12 7/8 in)	152 mm (6 in)	311 mm (12 1/4 in)	235 mm (9 1/4 in)	133 mm (5 1/4 in)	1.8 kg (4 lb)	2.5 kg (5 1/2 lb)	4C-9655, 3 Pc.	4C-9741
4C-9656	Pelican Case™	470 mm (18 1/2 in)	387 mm (15 1/4 in)	175 mm (6 7/8 in)	432 mm (17 in)	299 mm (11 3/4 in)	152 mm (6 in)	3.2 kg (7 lb)	3.9 kg (8 1/2 lb)	4C-9657, 3 Pc.	4C-9742
4C-9658 ⁽⁸⁾	Case - Protective	521 mm (20 1/2 in)	425 mm (16 3/4 in)	216 mm (8 1/2 in)	483 mm (19 in)	356 mm (14 in)	197 mm (7 3/4 in)	4.5 kg (10 lb)	6.2 kg (14 lb)	4C-9659, 4 Pc.	4C-9743
4C-9660	Carry Case	591 mm (23 1/4 in)	527 mm (20 3/4 in)	229 mm (9 in)	559 mm (22 in)	432 mm (17 in)	203 mm (8 in)	6 kg (13 lb)	11.5 kg (25 lb)	—	4C-9744
4C-9662	Instrument Case, 355 x 832 x 115 mm (14.0 x 32.8 x 4.5 in)	940 mm (37 in)	445 mm (17 1/2 in)	152 mm (6 in)	914 mm (36 in)	343 mm (13 1/2 in)	127 mm (5 in)	6.8 kg (15 lb)	7.7 kg (17 lb)	4C-9663, 3 Pc.	4C-9745
4C-9664 ⁽⁹⁾	Travel Vault	1321 mm (52 in)	445 mm (17 1/2 in)	152 mm (6 in)	1289 mm (50 3/4 in)	323 mm (13 1/2 in)	127 mm (5 in)	11.8 kg (26 lb)	13 kg (29 lb)	4C-9665, 3 Pc.	4C-9746

8 Fold-down handle

9 Supplied with regular foam; Pick-N'Pluch is not available

Abrasives — Brushes	206
Radial Knot Brushes — Stringer Bead-Type Wheels	206
Bench Grinder Wire Brushes.....	206
Cylinder Block Cleaning Brushes.....	206
Interleaf Flap Brush	207
Crimped End Wire Brushes	207
Cup End Wire Brushes	208
Stem Mount Wire Brushes	208
Abrasives — Discs	209
Type 29 Zirconium Flap Discs.....	209
Type 29 Zirconium Flap Disc with 5/8 -11 Hub.....	209
Hi-Density Zirconium Flap Disc with 5/8 -11 Hub	210
Aluminum Oxide Surface Reconditioning Discs	210
Surface Reconditioning Discs — Superior Edge Wear.....	211
Disc Pad Holders.....	211
Roloc Surface Conditioning Discs.....	212
Surface Reconditioning Discs for Aluminum Surfaces	213
Aluminum Oxide Discs.....	214
Surface Reconditioning Discs — Bolt-On Style	214
Roloc Holders and Threaded Shaft Bristle Discs.....	215
Aluminum Oxide Fiber Discs	216
Bristle Discs.....	217
Rib-flow Backing Pads for Fiber Disc.....	217
R - Type Mini Grinding Discs.....	218
Discs	218
PSA Stick-It Discs	219
PSA Discs, Glue Backed, PSA/No Hole	219
PSA Sanding Discs	219
Hook and Loop Aluminum Oxide Film Back Sanding Discs	220
Hook and Loop Sanding Pads	220
Abrasives — Wheels	221
Clean 'N Strip Silicon Carbide Unitized Wheels	221
Light Silicon Carbide Deburring Wheel	221
Type 27 High Performance Zirconium Grinding Wheels	222
Type 27 Aluminum Oxide 4 inch Grinding Wheel.....	222
Finishing Flap Aluminum Oxide Brush Wheel.....	223
Level Cut Aluminum Oxide Unitized Wheel.....	223
Threaded Flap Wheels	224
Mandrels.....	224
Surface Condition Brush.....	225
Aluminum Oxide Large Flap Wheel Sander	225
1/4 Inch Shank Abrasive Flap Wheels.....	225
Zirconium Raised Hub Wheels	226
Aluminum Oxide Raised Hub Wheels.....	227
Cut-Off Wheels	227
Thin Cut Abrasive Cutting Wheels.....	229
Drill Sharpening Wheels (Type 1).....	229
Mandrel for Small Abrasive Wheels.....	229
Portable Wheels — Reinforced (Type 1)	230
Bench and Pedestal Wheels (Type 1)	230
Aluminum Oxide Flaring Cup Snagging Wheels (Type 11).....	231
Mandrel #936.....	231
Abrasives — Miscellaneous	232
Abrasive Hand Pads	232
Aluminum Oxide Cutting and Polishing Rolls	232
Adapter Mandrel #935	233

Shop Supplies

Polishing Stone.....	233
Sanding Cloth Rolls.....	233
Sanding Sheets.....	234
Surface Conditioning Belts.....	235
Sanding Belts.....	235
Aluminum Oxide Cleaning and Polishing Stars.....	235
Surface Reconditioning Flex-Hone Tools.....	236
Mounted Points.....	237
Threaded Cones and Plugs.....	238
Carbide Burrs.....	239
Aluma Cut Carbide Burrs.....	239
Spira Bands.....	239
Screen-Bak Durite Rolls.....	240
Decal Removal.....	240
Nylon Cleaning Brushes.....	241
Tube Brush.....	241
Brass Bristle Cleaning Brush.....	241
Parts Cleaning Brush.....	242
Metal Cutting — Drill Bits.....	243
Standard Drill Bits.....	243
Reduced Shank Drill Bits.....	244
Heavy-Duty Drill Bits, 135° Split Point.....	244
Extra Heavy-Duty Cobalt Drill Bits, 135° Split Point.....	245
Aircraft Drill Bits.....	246
Left Hand Drill Bits.....	247
Metric Standard Drill Bits.....	247
Drill Bit Index - 4C-3385.....	248
Drill Extension - 4C-4426.....	248
Recommended Drill Bit Sizes for Metric Thread.....	248
Metal Cutting — Taps and Dies.....	249
Abbreviations Used for Taps and Dies.....	249
Hand Taps.....	249
Machine Screw Set - 1P-3020.....	250
Fractional Size Tap Set - 1P-3070.....	251
Fractional Size Tap Set - 1P-3050.....	251
Special Thread Taps.....	252
Rethreading Dies.....	252
Hexagon Rethreading Fractional Die Set - 1P-3000.....	252
Hexagon Rethreading Metric Die Set - 4C-4963.....	254
Hexagon Rethreading Pipe Dies - Individual.....	254
Special Rethreading Dies.....	254
Universal Outside Thread Chasers.....	255
Thread File Group - 154-9315.....	255
Taper Pipe Tap Set - 2P-5530.....	256
Metric Size Taps - Individual.....	256
Tap Wrenches.....	257
Metal Cutting — Extractors.....	258
Individual Extractors.....	258
Extractor Sets.....	259
Left Hand Spiral Screw Extractor - 1B-9925.....	259
Extractor Set, 10 piece - 282-2108.....	260
Stud Remover Set - 2P-5535.....	260
Stud Remover and Resetter Tool Set, 1/4 through 5/8 in - 8S-1378.....	261
Metric Stud Installers.....	262
Metal Cutting — Cutting Torch Equipment.....	263
Mini Cutting Torch - 8T-7792.....	263

Metal Cutting — Miscellaneous	264
Surface Texture Replica (Comparison) - 9A-1593.....	264
Metal Etching Pen.....	264
Metal Repair	265
Full-Torque® Thread Repair Kits.....	265
263-7147 Lock-N-Stitch® Crack Repair Kit.....	266
Heli-Coil® Inserts.....	267
Master Thread Repair Sets.....	268
Metric Master Thread Repair Set - 4C-8366.....	269
Metric Master Thread Repair.....	270
Metric Thread Repair Kits.....	270
Spark Plug Thread Repair.....	271
Carded Inserts.....	271
Inserts for Specific Engine Applications.....	273
Inserts for Specific Engine Applications.....	273
Thread Inserts.....	274
English and Metric Thread Insert Master Kits.....	276
Insert Kits and Replacement Kits.....	276
Installation Tools and Thread Inserts.....	278
Weld Wire.....	279
Caps and Plugs	281
Cap and Plug Kit - 276-7018.....	281
Conduit Covers.....	281
ORFS Plugs.....	282
JIC 37° Plugs.....	282
Straight Thread O-Ring - Hex Head Plugs.....	283
Straight Thread O-Ring - Hex Drive Plugs.....	283
Pipe - Hex Head Plugs.....	283
Pipe - Square Head Plugs.....	284
Pipe - Square Drive Plugs.....	284
Pipe - Hex Drive Plugs.....	284
JIS - BSPP Shipping Plugs.....	285
Metric Plugs.....	285
SAE Code 61 Flange Port Cover.....	285
Cat Flange Port Cover.....	286
Tapered Dual-Function Caps and Plugs.....	286
Straight Cap.....	288
Non-threaded Caps.....	288
Metric Threaded Cap Protectors.....	289
Metric Threaded Plug Protectors.....	289
Threaded Plug Protectors for Flared Fittings.....	290
Threaded and Slotted Plug Protectors.....	290
Plug Protectors for NPT Thread - Square Head.....	290
Plug Protectors for NPT Thread - Knurled Head.....	291
Tear Cap Protectors for Standard Thread.....	292
SAE Code Flange 61 Bolted Protectors.....	292
British Thread - BSP/GAS Plug Protectors.....	293
SAE Code 62 and Caterpillar Flange Bolted Protectors.....	293
Vises	294
Tradesman Vises.....	294
Machinist Vises.....	294
6 1/2" Tradesman Vise - 377-5722.....	295
Combination Pipe and Bench Vises.....	295
Model R — Rubber Face Magnefix Jaw Caps.....	295
Model P — Prism Magnefix Jaw Caps.....	296
Jaw Caps.....	296

Shop Supplies

Holding Fixture.....	296
Yoke Pipe Vice	297
Regular Duty, Standard Throat C-Clamps.....	297
Battery Service Equipment	298
Cat Battery Tester	298
Multi-Battery Parallel Chargers.....	299
Bus Bar Set - 4C-4917	300
Battery Charging Rack	300
Heavy-Duty Commercial Fast Chargers	301
Portable Chargers	302
Extra Heavy-Duty Plug-In Starting System.....	303
Heavy-Duty Plug-In Starting System.....	303
Flush Mount Power Socket	304
Booster Cables	304
Replacement Clamps	305
Battery Post Set.....	305
Cables.....	305
Battery Cable Repair Kit - 6V-3025	306
Lighting and Electrical Products — Flashlights and Batteries	307
Mini-Maglite Flashlight.....	307
Heavy-Duty Professional Flashlights.....	307
Heavy-Duty Professional Rechargeable Flashlight Accessories	307
Heavy-Duty Flashlights	308
Continuity Tester/Flashlight.....	308
Inspection Light - 141-1655	309
Industrial Batteries	309
Pen Light	310
Hi-Energy Battery Charger	310
AA Rechargeable Batteries	311
Lantern Battery.....	311
Lighting and Electrical Products — Work Lights and Extension Cords	312
Portable Fluorescent Work Lights	312
Accessories for Light Assemblies	312
Fluorescent Light Kit	312
Ratchet Light.....	313
Angle Light Reel.....	313
Angle Light.....	314
Triple-Tap Extension Cord.....	314
Light Rover.....	315
Work Light	315
Electrical Cord Definitions.....	316
Heavy-duty Contractor and Industrial Application Extension Cords.....	316
Heavy-Duty Connectors and Plugs (20-30 Amps) with Insulating Cord Grip.....	317
Lighting and Electrical Products — Miscellaneous.....	318
Rubber Splicing Compound	318
Wire Marker Tape Dispenser	318
Crimping Tools	319
Heat Shrinking Tubing	319
Heat Shrinking Butt Connector.....	319
Cold Shrink Insulators	320
Wedge Removal Tool	320
Straight Blade Plugs and Connectors	320
Sure Seal Series Field Service Kit.....	321
Personal Protective Equipment — Gloves	323
Utility Glove.....	323
Utility Gloves	323

Impact Gloves.....	324
Insulated Gloves	324
Fingerless Gloves	325
Padded Utility Glove.....	325
High Visibility Padded Utility Glove.....	326
Water-Resistant Utility Glove	326
Leather-Driver Glove	327
High-Visibility Leather Driver Glove	327
High-Visibility Leather Palm Glove	327
Fingerless Leather Glove.....	328
Unlined Grain Leather Driver's Gloves	328
Lined Leather Driver's Gloves	328
Split Leather Palm Gloves	329
Split Cowhide Palm Gloves.....	329
Traditional All-purpose Gloves	329
Fleece-Lined Dotted Jersey Glove	330
Dotted Jersey Glove	330
Jersey Gloves.....	330
Fleeced Gloves	331
Leather Welding Gloves.....	331
Chemical-resistant Nitrile Gloves.....	331
Neoprene-coated Gloves	332
Nitrile-coated Knit-lined Gloves.....	332
Neox Gloves with Neoprene Coating	332
Neoprene-coated Knit-lined Gloves	333
Best Nitrile Disposable Gloves	333
Disposable Powder-Free Nitrile Gloves.....	333
Disposable Powdered Nitrile Gloves	334
Disposable Latex Gloves.....	334
Nitrile Coated Glove.....	334
High-Visibility Nitrile Coated String Knit Glove.....	335
Nitrile Coated Bamboo Glove.....	335
Cut Resistant Gloves, Level 2	335
Cut Resistant Gloves, Level 4	336
Nylon Gloves with Nitrile Coating	336
Personal Protective Equipment — Safety Vests	337
Safety Vests	337
Personal Protective Equipment — Eye Protection	338
Cat Safety Glasses - Tread	338
Cat Safety Glasses - Dozer.....	338
Cat Safety Glasses - Track	339
Cat Safety Glasses - Mortar	339
Cat Safety Glasses - Grit.....	340
Cat Safety Glasses - Guard.....	340
Cat Safety Glasses - Torque.....	341
Wraparound Safety Glasses	341
Safety Glasses.....	341
Safety Glasses.....	342
Safety Glasses.....	342
Safety Glasses.....	342
Safety Glasses.....	343
Safety Glasses.....	343
Safety Glasses.....	343
Safety Goggles	345
Safety Goggles	345
Lanyard for Safety Glasses.....	345

Shop Supplies

All-purpose Wipers.....	346
Lens Cleaning Towelettes.....	346
Lens Cleaning Station.....	346
Heavy-Duty Headgear	347
Face Shield	347
Personal Protective Equipment — Hearing Protection.....	348
Disposable Ear Plugs	348
Reusable Uncorded Ear Plugs.....	348
Disposable Foam Ear Plugs	348
Band Ear Plugs	349
Silencer Ear Muffs.....	349
Multipositional Ear Muff	349
Ear Muffs.....	350
Personal Protective Equipment — Hard Hats	351
Hard Hats	351
Hard Hat Winter Liner	351
Personal Protective Equipment — Breathing Protection	352
Particulate Respirator	352
Welding Respirator	352
Dust Mask	353
Personal Protective Equipment — First Aid Kits	354
Personal First Aid Kit - 150-1578	354
Portable First Aid Kit - 150-1579.....	355
Worksite First Aid Kits, 25 and 50-person	356
First Aid Kit - 389-2195	357
Personal Protective Equipment — Welding Protection	358
Welding Helmet	358
Welding Helmet	358
Welding Goggles.....	358
Welding Goggles with Lift Front Lens.....	359
Welding Blanket.....	359
Contamination Control	360
Engine Cover	360
Seat Covers	360
Wall Mount Dispenser.....	360
Floor Cover	360
Cabinet Cover - 449-8227.....	361
Steering Wheel Covers.....	361
Dust Cap for 55 Gallon Drum.....	361
Barrel Cover.....	362
Zipper-Top, Clear Bags for Contamination Control	362
Fluid Sampling Equipment.....	363
Fluid Sampling Extraction Tools for Pressurized Compartments.....	363
Fluid Sampling Extraction Tools for Non-Pressurized Compartments.....	365
Oil Safe Containers	366
Towels and Wipers	368
DRC Quarter-Fold Wipers.....	368
DRC Pop-Up Shop Towels	368
DRC Center-Pull Roll Dry Shop Towels.....	368
DRC Center - Pull Shop Towels.....	369
DRC Jumbo Roll Shop Towels	369
All-Purpose Wipers	369
Wipers	370
Low Lint Task Wipers	370
Manufactured Rags	370
Manufactured Pop-up Rags.....	371

Dispensers for Manufactured Rags and Paper Wipers.....	371
Hard Roll Towels	371
Shop Towel	372
Absorbents and Spill Kits — Absorbents.....	373
Oil Absorbent Pads	373
Absorbent Socks.....	373
Absorbent Pillows	374
Heavyweight Absorbent Material for Most Oil, Water-Based Fluids and Chemicals	375
Rip & Fit Absorbent Mat - 385-5560	376
High-Visibility Absorbent Mat	376
Oil-Only Absorbent Material	377
Lightweight Absorbent Roll.....	378
Floor Dry - 4C-5751	378
Absorbents and Spill Kits — Spill Kits.....	379
Sorbent Spill Kits.....	379
Small Spill Response Bag.....	380
Small Spill Response Cart	380
Small Spill Response Cart	381
Large Spill Response Kit	382
Floor Mats.....	383
473-6461 Grippy Absorbent Traffic Floor Mat.....	383
Rugs	383
WorkSafe Floor Mat.....	383
Rejuvenator Connect Modular Floor Mat.....	384
Weldsafe Floor Mat	384
Clean Walk Mats.....	384
Tape.....	385
General Purpose Masking Tape.....	385
Masking Paper	385
Masking Tape.....	385
Label Protection Tape	386
Filament Tape	386
Filament Tape	386
Transparent Tape	387
Double-faced Tape	387
Thread Seal Tape	388
Duct Tape	388
High Performance Duct Tape.....	388
Electrical Tape.....	389
Electrical Tape.....	389
Aluminum Tape.....	389
Box Sealing Tape Dispenser.....	390
Filament Tape Dispenser.....	390
Rubber Mastic Tape.....	390
Packing Supplies and Equipment.....	391
Handwrappers.....	391
Adjustable Stretch Band-it Tool.....	391
Stretch Band-it Tool.....	391
Stretch Band-it Stand.....	392
Heavy-Duty Master Wrap Film	392
Stretch Film.....	392
Hand Wrap Standard-Duty Stretch Film	393
Heat Shrink Bags	393
Cardboard Boxes with Cat Logo	393
Heat Shrink Sheeting	394
Maintenance Products Box.....	394

Shop Supplies

Plastic Bags with Cat Logo.....	394
High Performance Steel Strapping.....	395
Strapping Seals	395
High Performance Nylon Cord Strapping.....	395
Shrinkfast Shrink Gun.....	396
Poly Coat Paper	396
Electric Tie Strap Tightener	397
Label Maker Kit.....	397
Miscellaneous — Padlocks.....	398
Combination Padlock - 285-1145	398
Combination Padlock - 285-1146	398
High Security Brass Padlock - 285-1147	398
High Security Brass Padlock - 285-1148	398
High Security Brass Padlock - 285-1149	399
High Security Brass Padlock - 285-1150	399
Miscellaneous — Ladders	400
Step Ladders and Shelf Ladders.....	400
Miscellaneous — Janitorial Products	401
Brooms	401
Janitorial Equipment	401
Trash Can or Waste Receptacle Liners	402
Heavy Duty Garbage Bags	402
Miscellaneous — Highway Warning Kit	403
Triangular Highway Warning Kit.....	403
Miscellaneous — Sprayers	404
Reusable, Bulk-Liquid Sprayers.....	404
Miscellaneous — Miscellaneous Products	405
Poly Coat Paper	405
Cable Ties and Applicators.....	405
Electric Tie Strap Tightener	406
Tyvek Coveralls.....	406
Rain Jackets and Pants	407
Paper Cups	408
Eye Loupe	408
Tie Down Straps.....	408
Black Wire.....	408
Creeper	409
Funnel Kit	409
Funnel.....	409
Sink Filter Sock Kit - 189-5637	410
Digital Stopwatch - 386-3238.....	410
Python Cinch Straps	410
Plastic Cover – 463-5569	411
Paint — Cat Paint	412
Cat Enamel Topcoats.....	412
Cat Black Muffler Paint	413
Cat Yellow Primer Paint	413
Paints — Paint Thinner.....	414
Cat Paint and Primer Thinner	414
Cat Paint and Primer Thinner with Retarder.....	414
Maintenance Chemicals — Soaps and Cleaners	415
Windshield Cleaner	415
Xtreme Windshield Washer Fluid.....	415
Plastic and Rubber Protectant	415
Seal Installation Kit.....	415
Air Filter Cleaning Kit	416

Cabinet Washers and Agitating Tanks	416
Pressure Wash	417
Defoamant and Descaleant/Conditioner	417
General Purpose Detergents.....	418
Chemtool LAC 110 All-Purpose Cleaner Concentrate.....	418
Cat Orange Hand Cleaner.....	418
Cat Heavy-Duty Hand Cleaners	419
Cat Battery Cleaner	419
Cat Battery Saver	419
Cat Mineral Spirits.....	420
Maintenance Chemicals — Adhesives and Sealants.....	421
Clear Adhesive Sealant	421
Heat Sink Compound.....	421
High Temperature Anti-Seize	421
Cat Manifold Sealer	421
Window Bonding Adhesives and Tooling.....	422
To Bond Large Windows.....	422
Epoxy Adhesive, Nozzle Mixer, Applicator (Model 3500)	422
Maintenance Chemicals — Lubricants	423
CT2 Air Tool Oil/Lubricant.....	423
Cat Heavy Duty Penetrating Oil	423
Cat Dry Film Lubricant	423
Cat Chain and Cable Lubricant	423
Cat Camshaft and Follower Lubricant	424
Cat Silicone Lubricant	424
Cat Air Conditioning Pump Lubricants—PAG Oil	424
Rubber Lubricant.....	425
Cat P-80 Assembly Lubricant	425
Cat Tire Lubricant.....	425
Maintenance Chemicals — Metal Working	426
Cat 119 Cutting Oil	426
Cat 250 Grinding Fluid.....	426
DYKEM Hi Spot Bluing Paste	426
Maintenance Chemicals — Testing Products.....	427
Oil Dyes.....	427
Aerosol Liquid Penetrant and Developer	427
UV Visible Dyes for Leak Detection	428
UV Flashlight Kit - 459-0184.....	429
Leak Detection Kit	429
Cat Calibration Fluid.....	430
Gear Marking Compound - 381-0022.....	430
Maintenance Chemicals — Rust Preventatives	431
Cat Rust Preventive Oil 450.....	431
Cat Rust Preventive Oil 4A.....	431
V.C.I. Oil.....	431
Maintenance Chemicals — Miscellaneous Chemicals	432
Ether Cylinder	432
CT2 Antifreeze and Rust Guard.....	432
Anti-Spatter Compound	432
Thermally Conductive RTV Kit	433
Cat Vacuum Pump Oil.....	433
UPS 250 Vacuum Pump Oil	433
Dielectric Tune-Up Grease	434
Cat Rust Preventative.....	434
Cat Silicone Fluid.....	434

Abrasives — Brushes

Radial Knot Brushes — Stringer Bead-Type Wheels



Warranty: Cat Standard Warranty, 6 Months

- Designed for heavy duty cleaning, scale, spatter and rust removal
- High quality oil tempered wire gives long life on pipe and plate weld cleaning

Part Number	Package Quantity	Diameter	Arbor Hole (A.H) Threaded Size	Wire Size	Max. Safe Free Speed (RPM)
1U-9957	1	76.2 mm (3 in)	9.5 mm (3/8 in) A.H.	0.36 mm (0.014 in)	25,000

Bench Grinder Wire Brushes



Warranty: Cat Standard Warranty, 6 Months

- General purpose wire brushes that provide fine to medium brushing action
- Excellent for brushing uneven surfaces or areas not easily reached by wider brushes
- Will remove light scale, dirt, rust, corrosion or light burrs

Part Number	Package Quantity	Wheel Diameter	Arbor Hole	Wire Size	Face Width	Max. Safe Free Speed (RPM)
1U-9971	1	152.4 mm (6 in)	12.7 - 15.9 mm (1/2 - 5/8 in)	0.36 mm (0.014 in)	15.88 mm (5/8 in)	6,000
1U-9972	1	152.4 mm (6 in)	12.7 - 15.9 mm (1/2 - 5/8 in)	0.36 mm (0.014 in)	25.4 mm (1 in)	6,000
1U-9974	1	203.2 mm (8 in)	15.9 mm (5/8 in)	0.36 mm (0.014 in)	25.4 mm (1 in)	4,500

Cylinder Block Cleaning Brushes



Warranty: Manufacturer, 90 Day

- Used during rebuild to clean oil passages and cylinder bores after honing
- Circular brushes with nylon bristles and a single stem, single spiral, and carbon steel wire handle

Part Number	Brush Diameter	Part Number	Brush Diameter	Part Number	Brush Diameter
135-7628	304.8 mm (12 in)	6V-7092	15.9 mm (5/8 in)	1U-9788	127.0 mm (5 in)
1P-5571	9.5 mm (3/8 in)	6V-7093	25.4 mm (1 in)	4C-6344	139.7 mm (5 1/2 in)
1P-5572	19.1 mm (3/4 in)	6V-7094	38.1 mm (1 1/2 in)	4C-6345	152.4 mm (6 in)
1P-5573	31.8 mm (1 1/4 in)	6V-7095	44.5 mm (1 3/4 in)	4C-6346	165.1 mm (6 1/2 in)
1P-5574	127.0 mm (5 in)	6V-7096	50.8 mm (2 in)	4C-6347	177.8 mm (7 in)
6V-3182	7.9 mm (5/16 in)	4C-5552	57.2 mm (2 1/4 in)	4C-6348	190.5 mm (7 1/2 in)
6V-3183	11.1 mm (7/16 in)	4C-6342	88.9 mm (3 1/2 in)	4C-6349	203.2 mm (8 in)
6V-7067	6.4 mm (1/4 in)	4C-6343	101.6 mm (4 in)	4C-6350	241.3 mm (9 1/2 in)
6V-7091	12.7 mm (1/2 in)	1U-7429	114.3 mm (4 1/2 in)		

Interleaf Flap Brush



Warranty: Manufacturer, 120 Day

- Non-woven surface conditioning material and aluminum-oxide abrasive flaps with cloth backing
- Epoxy filled center with 6.4 mm (.25 in) shank
- Used to clean curved and irregular shaped parts with hard to reach areas
- Use in place of wire wheels, hand scrapers, and wire brushes
- Typical applications include cleaning up both hydraulic cylinders and engine lower bores
- Can also be used to clean rust, carbon deposits, adhesives, and tough coatings

Part Number	Size	Grade	Grit
254-5310	38 x 25 mm (1.5 x 1 in)	Coarse	60
254-5311	38 x 25 mm (1.5 x 1 in)	Medium	120
254-5312	38 x 25 mm (1.5 x 1 in)	Very Fine	240

Part Number	Size	Grade	Grit
254-5313	76 x 51 mm (3 x 2 in)	Coarse	60
254-5314	76 x 51 mm (3 x 2 in)	Medium	120
254-5315	76 x 51 mm (3 x 2 in)	Very Fine	240

Crimped End Wire Brushes



Warranty: Manufacturer, 120 Day

- Steel Wire
- 1/4 inch shank
- End brushes are suitable for operation over a wide range of speeds to accommodate various jobs. At a moderate RPM the wires maintain a general end position for tip action. Higher speeds cause flaring action which can be beneficial in conforming to irregular shapes and contours.
- Used to clean large metal surfaces
- Remove burrs, weld scale, and rust
- Good for edge blending and surface preparation

Part Number	Description	Gauge	Size	Dimensions	Quantity	RPM
4C-6157	Encapsulated Flair-Flex	.010	1 1/2 in (38 mm)	—	1	25,000
262-9721	Straight Wire	.006	1/2 in (13 mm)	—	1 Box of 10	22,000
262-9722	Straight Wire	.006	3/4 in (19 mm)	76 x 63.5 mm (3 x 2 1/2 in)	1 Box of 10	22,000
262-9723	Straight Wire	.006	1 in (25 mm)	76 x 63.5 mm (3 x 2 1/2 in)	1 Box of 10	22,000
262-9726	Straight Wire	.020	1/2 in (13 mm)	76 x 63.5 mm (3 x 2 1/2 in)	1 Box of 10	22,000
262-9727	Straight Wire	.020	3/4 in (19 mm)	76 x 63.5 mm (3 x 2 1/2 in)	1 Box of 10	20,000
1U-9939	Knot	.020	1 in (25 mm)	—	1	20,000
1U-9940	Straight Wire	.020	1 in (25 mm)	—	—	20,000
1U-9941	Straight Wire	.020	3/4 in (19 mm)	—	—	20,000
1U-9942	Circular End	.020	1 1/2 in (38 mm)	—	1	15,000
1U-9943	Knot	.020	3/4 in (19 mm)	—	1	20,000
1U-9945	Galvanized	.020	3 in (76 mm)	—	—	5,000
1U-9946	Galvanized	.014	3 in (76 mm)	—	—	5,000
4C-6153	Straight Wire	.010	1 in (25 mm)	—	—	20,000
4C-6154	Straight Wire	.010	1 in (25 mm)	—	—	20,000

Abrasives — Brushes

Crimped End Wire Brushes (Cont'd.)

Part Number	Description	Gauge	Size	Dimensions	Quantity	RPM
4C-6158	Knot	.014	1 in (25 mm)	—	1	20,000
262-9728	Straight Wire	.020	1 in (25 mm)	76 x 63.5 mm (3 x 2 1/2 in)	1 Box of 10	—
262-9729	Knot	.014	3/4 in (19 mm)	76 x 63.5 mm (3 x 2 1/2 in)	1 Box of 10	—

Cup End Wire Brushes

262-9724



262-9720

262-9725

Warranty: Manufacturer, 120 Day

- 5/8 - 11 Thread
- Used to clean large metal surfaces
- Remove burrs, weld scale, and rust
- Good for edge blending and surface preparation
- Steel Wire

Part Number	Description	Gauge	Size	Dimensions	Package Quantity	Max. Speed (RPM)
262-9720	Knot Double Row	.023	6 in (152 mm)	76 mm x 152 mm (3 in x 6 in)	—	6,000
262-9724	Straight Wire	.014	6 in (152 mm)	76 mm x 152 mm (3 in x 6 in)	1 Box of 10	6,000
262-9725	Single Knot Row	.014	6 in (152 mm)	76 mm x 152 mm (3 in x 6 in)	—	6,000

Stem Mount Wire Brushes



Warranty: Manufacturer, 120 Day

- Steel Wire
- 1/4 inch shank
- Used to clean metal surfaces
- Remove burrs, weld scale, and rust
- Good for edge blending and surface preparation

Part Number	Wire Gauge	Size	Package Quantity	Max. Speed (RPM)
249-5284	.010	1 1/2 in (38 mm)	—	25,000
249-5285	.011	2 in (52 mm)	—	25,000
249-5286	.011	2 1/2 in (64 mm)	—	25,000

Type 29 Zirconium Flap Discs



Warranty: Manufacturer, 120 Day

- Grind and finish in one operation—good for heavy stock removal as well as finishing—reduces downtime
- Unique design allows for consistent sharp edge as wheel wears away
- Has a built-in angle for less operator fatigue
- Fiberglass reinforced backer
- Long lasting Zirconium grain cloth-backed flaps

Part Number	Center Hole	Diameter	Grade	Package Quantity
236-8105	22.23 mm (7/8 in)	114.3 mm (4 1/2 in)	ZIR24	10
236-8106	22.23 mm (7/8 in)	114.3 mm (4 1/2 in)	ZIR36	10
236-8107	22.23 mm (7/8 in)	114.3 mm (4 1/2 in)	ZIR60	10
236-8109	22.23 mm (7/8 in)	114.3 mm (4 1/2 in)	ZIR80	10
236-8111	22.23 mm (7/8 in)	114.3 mm (4 1/2 in)	ZIR120	10
236-8114	22.23 mm (7/8 in)	152.4 mm (6 in)	ZIR60	10
236-8116	22.23 mm (7/8 in)	152.4 mm (6 in)	ZIR120	10
254-5336	22.23 mm (7/8 in)	178 mm (7 in)	ZIR36	10
254-5337	22.23 mm (7/8 in)	178 mm (7 in)	ZIR60	10
254-5338	22.23 mm (7/8 in)	178 mm (7 in)	ZIR80	10

Type 29 Zirconium Flap Disc with 5/8 -11 Hub



Warranty: Manufacturer, 120 Day

- Long lasting Zirconium cloth backed flaps
- Fiberglass reinforced backer
- Three popular grades
- Grind and finish in one operation
- Permanently attached metal hub

Part Number	Diameter	Hub Thread	Grade	Package Quantity
254-5339	144 mm (4.5 in)	5/8 -11	36G	10
254-5340	144 mm (4.5 in)	5/8 -11	60G	10
254-5341	144 mm (4.5 in)	5/8 -11	80G	10
254-5342	178 mm (7 in)	5/8 -11	36G	10

Abrasives — Discs

Hi-Density Zirconium Flap Disc with 5/8 -11 Hub



Warranty: Manufacturer, 120 Day

- Hi-density flap disc with 5/8 -11 permanently attached metal hub
- Good for stock removal as well as finishing
- Fiberglass reinforced backer
- Available in four popular grades
- Made with long-life Zirconium grain
- 35 - 50% more material than Standard Flap discs

Part Number	O.D.	Hub Thread	Grade	Package Quantity
254-5345	114 mm (4.5 in)	5/8 -11	36 grit	10
254-5346	114 mm (4.5 in)	5/8 -11	60 grit	10
254-5347	114 mm (4.5 in)	5/8 -11	80 grit	10
254-5348	114 mm (4.5 in)	5/8 -11	120 grit	10
254-5349	178 mm (7 in)	5/8 -11	36 grit	10
254-5350	178 mm (7 in)	5/8 -11	60 grit	10
254-5351	178 mm (7 in)	5/8 -11	80 grit	10

Aluminum Oxide Surface Reconditioning Discs



Warranty: Manufacturer, 120 Day

Conditioning surfaces with conventional abrasive discs often results in dimensioning, gouging, or undercutting. Wire brushes don't thoroughly remove contaminants which can lead to rework. Their wires can become loose, fly off, and injure an operator. Surface reconditioning discs can help reduce or eliminate these problems. They deliver superior, consistent finishes when you need to clean, deburr, blend or finish.

- Use disc coming off the edge—better finish results
- Aluminum Oxide
- Use for gasket removal
- Use for deburring, cleaning and rust removal
- Use instead of wire brushes or sand paper when you don't want to remove any stock

Part Number	Package Quantity	Grade	Diameter	Maximum Operating Speed (RPM)	Optimum Operating Speed (RPM)	Backing Pad
1U-7622	25	A-Coarse	101.6 mm (4 in)	13,000	10,000	4C-4763 (13,000), 1U-7623 (18,000)
4C-4383	50	A-Coarse	50.8 mm (2 in)	25,000	18,000	4C-4381
4C-4384	25	A-Coarse	76.2 mm (3 in)	18,000	15,000	4C-4382
5P-9709	25	A-Coarse	177.8 mm (7 in)	6,000	4,500	5P-9718
6V-0185	25	A-Coarse	127.0 mm (5 in)	10,000	10,000	6V-0186

Surface Reconditioning Discs — Superior Edge Wear

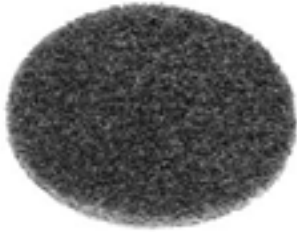

Warranty: Manufacturer, 120 Day

- Surface reconditioning disc used on right angle tools
- The edges of an abrasive on a right angle grinder tend to wear faster than the center and thus the disc is never fully used up. Superior edge wear discs have longer overall life than standard discs.
- Ideal for gasket removal, rust removal and general cleaning on steel parts
- Retained by hook and loop type fasteners or 7/8 inch bolt thru application
- Brown disc with gray backing

Part Number	Package Quantity	Description	Diameter	Maximum Operating Speed (RPM)	Optimum Operating Speed	Associated Tool
9U-6921	10	SE Disc — A Coarse	177.8 mm (7 in)	6,000	4,500	Grinder
9U-6922	10	SE Disc — A Coarse	127.0 mm (5 in)	10,000	10,000	Grinder
9U-6923	10	SE Disc — A Coarse	127.0 x 22.23 mm center hole (5 x 7/8 in)	10,000	10,000	Grinder
9U-6924	10	SE Disc — A Coarse	101.6 mm (4 in)	13,000 ⁽¹⁾	10,000	Grinder/ Hand Drill
9U-6925	10	SE Disc — A Coarse	101.6 x 22.23 mm center hole (4 x 7/8 in)	13,000	10,000	Grinder/ Hand Drill
9U-6926	10	Roloc — A Coarse	76.2 mm (3 in)	18,000	15,000	Die Grinder/ Hand Drill
9U-6927	10	Roloc — A Coarse	50.8 mm (2 in)	25,000	21,000	Die Grinder/ Hand Drill

Disc Pad Holders



Warranty: Manufacturer, 120 Day

Safety Tip

Place holder on table before turning tool on—prevents pad from flying off.

Part Number	Package Quantity	Used With	Description	Diameter	Hub/Shank	Maximum Operating Speed (RPM)
1U-5518	1	1U-5519 or 1U-5520	Replacement Threaded Shaft	—	—	—
1U-5519	1	9U-6927	R - type Holder	51.0 mm (2 in)	—	25,000
1U-5520	1	9U-6926	R - type Holder	76.2 mm (3 in)	—	20,000
1U-7623	—	1U-7622	Hook and Loop	101.6 mm (4 in)	6.35 mm shaft (1/4 in)	13,000
4C-4381	—	4C-4383	Hook and Loop	51.0 mm (2 in)	6.35 mm shaft (1/4 in)	25,000
4C-4382	—	4C-4384	Hook and Loop	76.2 mm (3 in)	6.35 mm shaft (1/4 in)	18,000
4C-4763	—	1U-7622	Pad Holder	101.6 mm (4 in)	M14 x 2	13,000
4C-4764	—	1U-7622	Hook and Loop	101.6 mm (4 in)	5/8 in-11	13,000

¹ Maximum speed is 13,000 if used with 4C-4763 Disc Pad Holder or 4C-4764 Disc Pad Holder and 155-3595 Adapter

Abrasives — Discs

Disc Pad Holders (Cont'd.)

Part Number	Package Quantity	Used With	Description	Diameter	Hub/Shank	Maximum Operating Speed (RPM)
5P-9718	–	5P-9709	Pad Holder	177.8 mm (7 in)	5/8 in-11	6,000
6V-0186 ⁽²⁾	–	150-1244	Pad Holder	127.0 mm (5 in)	5/8 in-11	10,000

Roloc Surface Conditioning Discs



Warranty: Manufacturer, 120 Day

- Uses a more positive retention method than the "hook and loop" fasteners system
- R-style discs have a quarter turn male fastener embedded into the disc. The disc holder has the corresponding female fastener.
- Typically used at smaller sizes where the higher maximum operating speed requires a more positive retention system
- The disadvantage of this system is that the surface conditioning operation must always be conducted in one direction only. Reversing the tool will "unspin" the disc from the holder.
- Aluminum oxide
- Use for gasket removal, deburring, cleaning, and rust removal
- Use instead of wire brushes or sand paper when you don't want to remove any stock

Part Number	Package Quantity	Diameter	Maximum Operating Speed (RPM)	Optimum Operating Speed (RPM)	Used With
R - type Surface Conditioning Discs					
1U-5516	25	50.8 mm (2 in)	25,000	18,000	1U-5519
9U-6927	10	50.8 mm (2 in)	25,000	21,000	1U-5519
9U-6926	10	76.2 mm (3 in)	18,000	15,000	1U-5520
1U-5517	25	76.2 mm (3 in)	18,000	15,000	1U-5520
R - type Disc Holders					
1U-5518	1	6.4 mm (1/4 in)	–	–	1U-5520 or 1U-5519
1U-5519	1	50.8 mm (2 in)	25,000	21,000	1U-5518
1U-5520	1	76.2 mm (3 in)	15,000	15,000	1U-5518

² Female, 5/8 in - 11; use 1U-9381 to adapt it.

Surface Reconditioning Discs for Aluminum Surfaces



Warranty: Manufacturer, 120 Day

- The ideal disc for aluminum
- Uses the same holders and grinders as other surface reconditioning discs

Fine Grade

- Very fine grade minimizes the chance of changing the surface profile
- Identified by blue/green color both front and back of disc

Medium Grade

- Medium grade material used much like coarse but is less aggressive in performance—used when very fine surface condition material is not quite aggressive enough
- Ideal for work requiring less pressure such as grind marks, surface rust, and mild coatings
- Brown disc with gray backing

Part Number	Package Qty.	Grade	Diameter	Maximum Operating Speed (RPM)	Optimum Operating Speed (RPM)	Used With	Qty.	Actual Diameter	Max. Hub/ Shank	Associated Tool
150-1197	10	A Fine, N.H.	177.8 mm (7 in)	6,000	4,500	—	—	—	—	Grinder
150-1244	10	A Fine, N.H.	127.0 mm (5 in)	10,000	10,000	—	—	—	—	Grinder
150-1246	10	A Fine	101.6 mm (4 in)	13,000 ⁽³⁾	10,000	—	—	—	—	Grinder/ Hand Drill
150-1248	10	A Fine	76.2 mm (3 in)	18,000	15,000	—	—	—	—	Die Grinder/ Hand Drill
150-1250	10	A Fine	50.8 mm (2 in)	25,000	21,000	—	—	—	—	Die Grinder/ Hand Drill
236-8092	25	Medium	76.2 mm (3 in)	18,000 rpm	15,000 rpm	—	—	—	—	Grinder
Holders										
1U-5519	1	R - type Holder	51.0 mm (2 in)	25,000	21,000	150-1250	1	44.45 mm (1 3/4 in)	—	Die Grinder, Hand Drill
1U-5520	1	R - type Holder	76.2 mm (3 in)	20,000	15,000	150-1248	1	69.85 mm (2 3/4 in)	—	Die Grinder, Hand Drill
1U-7623	—	Hook and Loop	101.6 mm (4 in)	13,000	10,000	150-1246	1	98.43 mm (3 7/8 in)	1/4 in Shaft	—
4C-4381	—	Hook and Loop	51.0 mm (2 in)	25,000	21,000	150-1251	1	44.45 mm (1 3/4 in)	—	—
4C-4382	—	Hook and Loop	76.2 mm (3 in)	18,000	15,000	150-1252	1	78.03 mm (2 7/8 in)	—	—
4C-4763	—	Pad Holder	101.6 mm (4 in)	13,000	10,000	150-1246	1	95.25 mm (3 3/4 in)	M14 x 2	—
4C-4764	—	Hook and Loop	101.6 mm (4 in)	13,000	10,000	150-1246	1	95.25 mm (3 3/4 in)	5/8 in-11	—
5P-9718	—	Pad Holder	177.8 mm (7 in)	6,000	4,500	150-1197	1	174.63 mm (6 7/8 in)	5/8 in-11	—
6V-0186 ⁽⁴⁾	—	Pad Holder	127.0 mm (5 in)	10,000	10,000	—	1	120.65 mm (4 3/4 in)	5/8 in-11	—

3 Maximum speed is 13,000 if used with 4C-4763, (4C-4764, 155-3595)

4 Female, 5/8 in-11; use 1U-9381 to adapt it.

Abrasives — Discs

Aluminum Oxide Discs

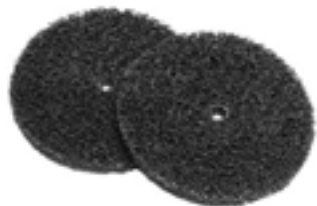

Warranty: Manufacturer, 120 Day

- Flexible discs can be used to remove corrosion and surface deposits
- Clean/strip designation indicates a coarse version of cutting/polishing disc
- Typical applications are clean up of hydraulic cylinders and engine lower bores
- Can be used in stacks of two or three, for whatever width is required to clean the surface in the most efficient manner
- Aluminum oxide
- Use for gasket removal, deburring, cleaning, and rust removal
- Use instead of wire brushes or sand paper when you don't want to remove any stock
- 279-2267 material is more aggressive so has a better cleaning and polishing effect than 6V-4086

Part Number	Package Quantity	Grade	Diameter	Maximum Operating Speed (RPM)	Optimum Operating Speed (RPM)
279-2267	1	A-Medium	152.4 x 6.35 mm (6 x 1/4 in)	4,000	3,200
4C-3868	1	Extra Coarse	101.6 x 6.35 mm (4 x 1/4 in)	6,000	4,500
6V-4086	1	A-Medium	152.4 x 6.35 mm (6 x 1/4 in)	4,000	3,200
8T-3054	1	Coarse	152.4 x 12.7 mm (6 x 1/2 in)	4,000	3,200

Surface Reconditioning Discs — Bolt-On Style



Warranty: Manufacturer, 120 Day

- Holders for these discs have a hook and loop type fastening system; not all the grinders in the shop will accept this kind of holder

Part Number	Package Quantity	Description	Diameter x Center Hole	Maximum Operating Speed (RPM)	Optimum Operating Speed (RPM)	Associated Tool
9U-6928	10	Disc — A Coarse	127.0 x 22.23 mm (5 x 7/8 in)	10,000	10,000	Grinder
9U-6929	10	Disc — A Coarse	101.6 x 22.23 mm (4 x 7/8 in)	13,000	10,000	Grinder

Roloc Holders and Threaded Shaft Bristle Discs



Warranty: Cat Standard Warranty, 6 Months

- Bristle design and 3-dimensional abrasives enable bristle discs to remove carbon buildup, coatings, sealants, gaskets and weld discoloration quickly, leaving a clean surface ready for subsequent operations or inspection
- Used with rotary tool such as drill or small angle grinder
- Designed to compete with crimped wire and bristle cup brushes
- Extends range of surface reconditioning operations where conformability and flexibility are most critical
- Provides exceptional finish, outstanding performance and a safer workplace by eliminating flying metal wires
- Come in 3 sizes and 3 grades
- All Roloc holders use 1U-5518 Threaded Shaft

Specifications	
Shaft size	6.4 mm (.25 in)
Disc package quantity	10
50 grit discs	carbon removal, weld discoloration clean up or where coating removal discs are used
80 grit discs	corrosion removal, sealant removal and general maintenance repair operations
120 grit discs	aluminum parts

Item	Part Number	Description	Diameter	Size	Package Quantity	Grit	Color	Maximum Operating Speed (RPM)	Optimum Operating Speed
Roloc Bristle Discs									
1	138-4523	Roloc Bristle Disc	25 mm (1.0 in)	1	10	50	Green	30,000	25,000
1	138-4524	Roloc Bristle Disc	25 mm (1.0 in)	1	10	80	Yellow	30,000	25,000
1	138-4528	Roloc Bristle Disc	51 mm (2.0 in)	2	10	50	Green	25,000	18,000
1	138-4529	Roloc Bristle Disc	51 mm (2.0 in)	2	10	80	Yellow	25,000	18,000
1	138-4530	Roloc Bristle Disc	51 mm (2.0 in)	2	10	120	White	25,000	18,000
1	138-4534	Roloc Bristle Disc	76 mm (3.0 in)	3	10	50	Green	20,000	15,000
1	138-4535	Roloc Bristle Disc	76 mm (3.0 in)	3	10	80	Yellow	20,000	15,000
1	138-4536	Roloc Bristle Disc	76 mm (3.0 in)	3	10	120	White	20,000	15,000
1	150-5431	2" Holder Medium ⁽⁵⁾	51 mm (2.0 in)	—	—	—	—	—	—
1	151-8101	Roloc Bristle Disc	25 mm (1.0 in)	1	10	120	White	30,000	25,000
2	151-8102	Holder for Bristle Discs	25 mm (1.0 in)	—	—	—	—	—	—
2	1U-5519	R - type Holder	51 mm (2.0 in)	—	1	—	—	25,000	21,000
2	1U-5520	R - type Holder	76 mm (3.0 in)	—	1	—	—	15,000	15,000
3	1U-5518	Replacement Threaded Shaft	—	—	1	—	—	—	—

5 Warranty: Manufacturer, 120 Day

Abrasives — Discs

Aluminum Oxide Fiber Discs



Warranty: Manufacturer, 120 Day

- Requires use with rib-flow backing pad noted in table below
- Aluminum oxide with resin fiber back
- 22 mm (7/8 in) center hole for use with 5/8 -11 arbor (except 236-8069 which has 16 mm (5/8 in) center hole)
- Resin bond with fiber backing for strength
- Used for medium and heavy stock removal on right-angle sanding equipment for:
 - Cutting down and blending weld lines
 - Cutting down filler metal, rust and scale removal, as well as deburring

Part Number	Grit	Pad Diameter	Package Quantity	Backing Pad
7/8 inch Arbor Hole				
1U-6827	24	114 mm (4 1/2 in)	25	254-5307
1U-6828	36	114 mm (4 1/2 in)	25	254-5307
1U-6829	50	114 mm (4 1/2 in)	25	254-5307
1U-6832	100	114 mm (4 1/2 in)	25	254-5307
1U-6834	24	127.0 mm (5 in)	25	254-5308
1U-6835	36	127.0 mm (5 in)	25	254-5308
1U-6836	50	127.0 mm (5 in)	25	254-5308
1U-6837	60	127.0 mm (5 in)	25	254-5308
1U-6838	80	127.0 mm (5 in)	25	254-5308
1U-6839	100	127.0 mm (5 in)	25	254-5308
1U-6841	24	178.0 mm (7 1/64 in)	25	254-5309
1U-6842	36	178.0 mm (7 1/64 in)	25	254-5309
1U-6843	50	178.0 mm (7 1/64 in)	25	254-5309
1U-6844	60	178.0 mm (7 1/64 in)	25	254-5309
1U-6846	100	178.0 mm (7 1/64 in)	25	254-5309
268-8709	16	114.0 mm (4 31/64 in)	25	254-5307

Bristle Discs



Warranty: Cat Standard Warranty, 6 Months

- Bristle design and 3-dimensional abrasive filled fingers enable bristle disc to remove carbon buildup, coatings, sealants, gaskets, and weld discoloration quickly, leaving a clean surface ready for subsequent operations or inspection
- Used with rotary tool such as drill or right angle grinder
- Used for coating removal, weld preparation, and general cleaning
- Increased safety during use—bristles are mounted securely to backing, virtually eliminating flying wires common with wire brushes
- Flexible, abrasive-filled bristles conform to part's surface and clean without removing base material, helping reduce damage and rework
- Unique bristle shape resists excessive edge wear and loading with coatings, dirt, and debris to extend disc life and performance
- Resists heat build-up to reduce potential tempering or work surface damage
- Threaded 5/8 -11 inch core quickly threads onto shaft of an electric or pneumatic right angle grinder
- Color coding makes abrasive grade selection quick and easy

Internal thread: 5/8 -11

Part Number	Size	Grit	Color	Maximum Operating Speed (RPM)	Optimum Operating Speed	Application
165-3945	4 1/2	50	Green	12,000	10,000	Carbon removal, weld discoloration cleaning, coating removal
165-3946	4 1/2	80	Yellow	12,000	10,000	Corrosion removal, sealant removal, general maintenance repair operations
165-3947	4 1/2	120	White	12,000	10,000	Aluminum parts

Rib-flow Backing Pads for Fiber Disc



Warranty: Manufacturer, 120 Day

- Rib-flow backing pads allow air flow through the ribs extending disc life from 20 to 50%
- Polyimide construction with steel insert and arbor nut
- Shipped in poly bag with 5/8 -11 arbor flange nut
- Available in three popular diameters
- For use with angle grinders with a 5/8 -11 spindle thread
- 254-5309 will fit 222-3064 or 222-3065 Pneumatic Angle Grinders

Part Number	O.D.	Max. Speed (RPM)	Package Quantity
254-5307	114.3 mm (4.5 in)	13,000	1
254-5308	127.0 mm (5 in)	11,900	1
254-5309	177.8 mm (7 in)	8,600	1

Abrasives — Discs

R - Type Mini Grinding Discs

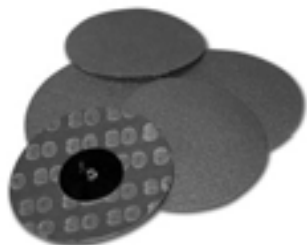

Warranty: Manufacturer, 120 Day

- Aluminum oxide with resin fiber back
- Manufactured with non-carcinogenic bonding agents—safer for the environment and dissipate heat while providing cooler cut for longer product life
- More coarse grits (24/36) best for weld removal, grinding, and deburring
- 50 grit best for blending; finer grits best for smooth sanding
- Resists stretching, shedding, and grain loss
- Maintains flexibility to work in contours
- Use with 1U-5519, 150-5431, and 1U-5520 R-Type Disc Holders

Part Number	Diameter	Grit	Package Quantity
236-8072	50.8 mm (2 in)	24	50
236-8073	50.8 mm (2 in)	36	50
236-8074	50.8 mm (2 in)	50	50
236-8075	50.8 mm (2 in)	80	50
236-8076	50.8 mm (2 in)	120	50
236-8078	76.2 mm (3 in)	24	25
236-8079	76.2 mm (3 in)	36	25
236-8081	76.2 mm (3 in)	50	25
236-8082	76.2 mm (3 in)	80	25
236-8083	76.2 mm (3 in)	120	25

Discs



Warranty: Manufacturer, 120 Day

- Excellent for cleaning welds, removing tough coatings, carbon deposits, adhesives and rust
- Conformable so there is less chance of under-cutting or gouging
- Open web resists loading even from soft coatings and is non-metallic so it will not contaminate the surface with metallic residues
- Will work at low RPM's, such as on a 6.35 mm (1/4 in) drill @ 1750 RPM
- Works well on other substrates such as wood, aluminum and even plastic

Part Number	Package Quantity	Description	Diameter	Maximum Operating Speed (RPM)	Optimum Operating Speed	Associated Tool
4C-8637	1	Clean 'N Strip 6.35 mm (1/4 in) Spindle Mounted Disc (CSD1-S)	101.6 x 12.7 x 6.35 mm (4 x 1/2 x 1/4 in)	8,000	8,000	Straight Grinder and Hand Drill
4C-8638	1	Clean 'N Strip 6.35 mm (1/4 in) Spindle Mounted Disc (CSD2-S)	101.6 x 25.4 x 6.35 mm (4 x 1 x 1/4 in)	8,000	8,000	Straight Grinder and Hand Drill

PSA Stick-It Discs



Warranty: Manufacturer, 120 Day

- Aluminum oxide, resin bond adhesive backed paper discs
- Special coating resists loading
- Paper weight: E
- Color: gold
- Material: aluminum oxide

Part Number	Size	Weight	Grit	Qty.
262-9736	127 mm (5 in)	E	40	100 per box

PSA Discs, Glue Backed, PSA/No Hole



Warranty: Manufacturer, 120 Day

- These discs have glue on the back and are used with backing pads to deburr, blend, etc.
- Pressure sensitive adhesive on disc back makes changes fast and easy
- Efficient on flat and contoured metal surfaces and hard to reach areas

Part Number	Grit	Description	Diameter x Hole	Package Quantity
4C-3809	36	Cloth Backed Disc	50.8 mm (2 in)	50
4C-3811	60	Cloth Backed Disc	50.8 mm (2 in)	50
4C-3813	100	Cloth Backed Disc	50.8 mm (2 in)	50
4C-3821	100	Cloth Backed Disc	101.6 mm (4 in)	50
4C-3822	120	Cloth Backed Disc	101.6 mm (4 in)	50
4C-3834	80	Cloth Backed Disk	304.8 mm (12 in)	25

PSA Sanding Discs

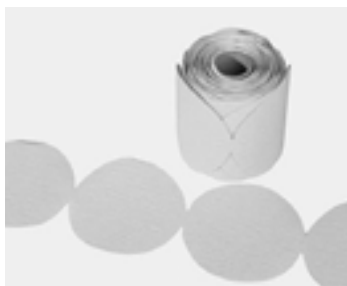

Warranty: Manufacturer, 120 Day

- Ideally used on dual action (DA) air and electrical random orbit sanders
- Used on metal, plastic, fiberglass, wood, and painted surfaces
- Anti-clog release agents are an additive process for long life
- Quality full resin-over-resin bond
- Each disc has protective backing to protect the adhesive in dusty environments before use
- Priced per roll

Part Number	Diameter	Grit	Package Quantity
236-8041	127 mm (5 in)	A/O 100	100
236-8043	127 mm (5 in)	A/O 150	100
236-8048	152.4 mm (6 in)	A/O 60	100
236-8049	152.4 mm (6 in)	A/O 80	100

Part Number	Diameter	Grit	Package Quantity
236-8051	152.4 mm (6 in)	A/O 120	100
236-8052	152.4 mm (6 in)	A/O 150	100
236-8053	152.4 mm (6 in)	A/O 180	100
236-8054	152.4 mm (6 in)	A/O 220	100

Abrasives — Discs

PSA Sanding Discs (Cont'd.)

Part Number	Diameter	Grit	Package Quantity	Part Number	Diameter	Grit	Package Quantity
236-8055	152.4 mm (6 in)	A/O 320	100	236-8056	152.4 mm (6 in)	A/O 400	100

Hook and Loop Aluminum Oxide Film Back Sanding Discs

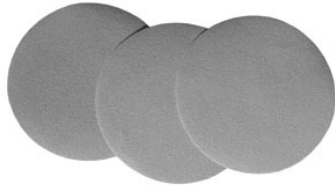

Warranty: Manufacturer, 120 Day

- Extremely tear resistant
- Resists loading on metal, paint and wood surfaces
- Strong backing
- Use with hook and loop sanding pads
- Material: aluminum oxide, film back resin bond
- Color: blue

Part Number	Diameter	Grit	Package Quantity
281-8271	127 mm (5 in)	100	50
281-8272	127 mm (5 in)	180	50
281-8273	152.4 mm (6 in)	100	50
281-8274	152.4 mm (6 in)	180	50
281-8275	152.4 mm (6 in)	220	50
281-8282	203.2 mm (8 in)	80	50

Hook and Loop Sanding Pads

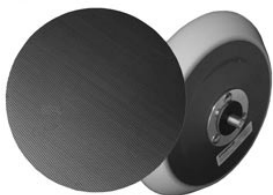

Warranty: Manufacturer, 120 Day

- Molded hook and loop sanding pad with plastic hub
- Use with hook and loop sanding discs

Part Number	Diameter	Size	Max. Speed (RPM)
275-5265	152.4 mm (6 in)	5/16 -24	10,000
275-5266	203.2 mm (8 in)	5/8 -11	4800

Clean 'N Strip Silicon Carbide Unitized Wheels

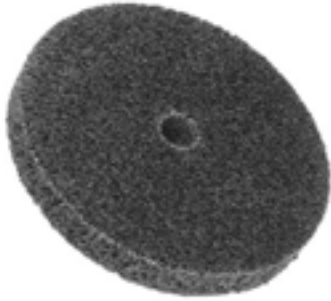

Warranty: Manufacturer, 30 Day

- Constructed of the most advanced material, Clean 'N Strip Unitized Wheels meet the demand for aggressive and durable cleaning products
- Designed to compete with power tool wire brushing, this product provides a cleaner, burr-free surface quicker than any wire fiber product
- Constructed of a non-woven nylon web, there is no opportunity for metal contamination or rusting in this product. It can be used on a variety of ferrous and non-ferrous metal surfaces
- Used extensively in weld cleaning and conditioning applications to provide the proper surfaces for high integrity welding and cleaned polish surfaces for non-destructive testing
- Use this product for heavy-duty cleaning of rust, corrosion and coatings of all types
- Use for gasket removal, deburring, cleaning, and rust removal
- Clean up to 4 times faster than wire brushes, runs smoothly and resists loading
- Use instead of wire brushes or sand paper when you don't want to remove any stock

Specifications						
Density	7					
Mineral type	S					
Color	Black					
Grade	XCS					
Part Number	Package Quantity	Wheel Size	Hole Size	Maximum Operating Speed (RPM)	Optimum Operating Speed	Used with
Clean 'N Strip Unitized Wheels						
8T-7769	40	38.1 x 25.4 mm (1 1/2 in x 1 in)	4.8 mm (3/16 in)	18,000	16,000	Die Grinder with 8T-7768

Light Silicon Carbide Deburring Wheel



Warranty: Manufacturer, 30 Day

- Widely used for fine deburring and polishing applications
- Designed to allow for removal of burrs without changing the dimension of the workpiece
- An excellent blending and radiusing tool
- Used in a variety of hand and automatic deburring and finishing applications including centerless polishing

Specifications	
Density	6
Mineral type	S
Color	Gray
Grade	Fine

Abrasives — Wheels

Light Silicon Carbide Deburring Wheel (Cont'd.)

Specifications	
6V-2032 Adapter	
Maximum operating speed	4,000
Number required	2

Part Number	Package Quantity	Description	Wheel Size	Hole Size	Maximum Operating Speed (RPM)	Optimum Operating Speed	Used with
8T-7748	3	Light Deburring Wheel	203.2 x 25.4 mm (8 in x 1 in)	76.2 mm (3 in)	4,500	4,500	Bench and Stand Grinder

Type 27 High Performance Zirconium Grinding Wheels



Warranty: Manufacturer, 120 Day

- Ideal for the toughest applications
- Provides extremely long life
- High performance Zirconium offers very fast stock removal and longer life
- Cool running
- Smoother, more consistent performance for operator
- Best choice for stainless, castings, welding seams, and hard metal grinding

Part Number	Size	Grade	Package Quantity
236-8070	100 mm x 6 mm x 9.53 mm (4 in x 1/4 in x 3/8 in)	4997, ZG	50
236-8071	100 mm x 6 mm x 15.88 mm (4 in x 1/4 in x 5/8 in)	4997, ZG	50
237-3653	100 mm x 6 mm x 22.23 mm (4 1/2 in x 1/4 in x 7/8 in)	4997, ZG	50

Type 27 Aluminum Oxide 4 inch Grinding Wheel



Warranty: Manufacturer, 120 Day

- Designed for grinding applications on ferrous metal such as grinding/smoothing weld seams and cleaning/shaping metal surfaces
- Material: aluminum oxide and resin

Part Number	Size	Type	Grade	Max. Speed (RPM)
262-9738	101.6 x 6.35 x 9.53 mm (4 x 1/4 x 3/8 in) hole	27	A24	15,000

Finishing Flap Aluminum Oxide Brush Wheel



Warranty: Cat Standard Warranty, 6 Months

- Fine grade flap brush replaces fine wire power brushes for removing carbon buildup, light rust and corrosion

Specifications	
Density	5
Color	Maroon
Grade	Fine

Part Number	Package Quantity	Wheel Size	Hole Size	Maximum Operating Speed (RPM)	Optimum Operating Speed	Typical Application
6V-2033	2	203.2 x 50.8 mm (8 in x 2 in)	76.2 mm (3 in)	4,000	3,200	Bench Grinder, Stand Grinders, Straight Grinders
Mandrel						
6V-2032	–	–	–	–	–	–

Level Cut Aluminum Oxide Unitized Wheel



Warranty: Manufacturer, 30 Day

- Made from an advanced material
- An excellent blending and polishing tool
- Used frequently in weld cleaning where high quality surface appearance is desirable

Specifications	
Density	5
Color	Tan
Letter color	Red
Grade	Fine

Part Number	Package Quantity	Wheel Size	Hole Size	Maximum Operating Speed (RPM)	Optimum Operating Speed
8T-7767	50	25.4 x 25.4 mm (1 in x 1 in)	4.8 mm (3/16 in)	35,100	22,000
Mandrel					
8T-7768	5	–	–	22,000	–

Abrasives — Wheels

Threaded Flap Wheels



Warranty: Manufacturer, 120 Day

- Flap wheels consist of a series of coated abrasive pieces (forming the spokes of the wheel) which are mounted around a steel hub
- Supplied with a 1/4 in-20 thread mandrel designed for fast mounting
- Can be used on higher speed machines popular in today's market
- Delivers smooth, chatter-free grinding

NOTE:

Best speed ranges from 6,000 to 9,000 SFPM (surface feet per minute). Wheels should be operated in direction of arrow. Never exceed maximum operating speed.

Optimum Surface Feet per Minute Speed	Type Material
5,500	Aluminum
4,000	Hardwood
5,000	Non-ferrous metals
5,000	Steel (alloy)
5,000	Steel (mild)
6,500	Steel (stainless)

Part Number	Package Quantity	Size	Grit	Max. Speed (RPM)	Description
4C-8511	10	1 in x 1 in	60	25,000	—
4C-8512	10	1 in x 1 in	120	25,000	—
4C-8513	10	1 in x 1 in	180	25,000	—
4C-8514	10	2 in x 1 in	60	20,000	—
4C-8515	10	2 in x 1 in	120	20,000	—
4C-8516	10	2 in x 1 in	180	20,000	—
4C-8517	10	3 in x 1 in	60	20,000	—
4C-8518	10	3 in x 1 in	120	20,000	—
4C-8519	10	3 in x 1 in	180	20,000	—
Mandrel					
4C-8520	—	1/4 inch x 1 inch	—	—	Adapter
4C-8521	—	1/4 inch x 4 inch	—	—	Adapter

Mandrels



Warranty: Manufacturer, 120 Day

Part Number	Description	Package Quantity	Used with	Diameter	Hub/Shank	Maximum Operating Speed (RPM)
6V-4087	Mandrel	1	6V-4086/4C-3868/279-2267	6.4 mm (1/4 in)	6.35 shank x 25.4 mm Dia. (1/4 x 1 in)	6,000
8T-3055	Mandrel	1	8T-3054	12.7 mm (1/2 in)	6.35 x 70.5 mm Dia. (1/4 x 2 1/2 in)	4,000

Surface Condition Brush



Warranty: Manufacturer, 120 Day

- Non-woven surface condition material with epoxy-filled center
- Available in three grades — very fine, medium, and coarse
- Shank size: 6.35 mm (.25 in)

Part Number	Size	Grade	Package Quantity
254-5316	38.1 x 25.4 mm (1.5 x 1 in)	Coarse	1
254-5319	76.2 x 50.8 mm (3 x 2 in)	Coarse	1
254-5317	38.1 x 25.4 mm (1.5 x 1 in)	Medium	1
4C-8630	76.2 x 44.5 mm (3 x 1 3/4 in)	Medium	1
254-5318	38.1 x 25.4 mm (1.5 x 1 in)	Very Fine	1
254-5320	76.2 x 50.8 mm (3 x 2 in)	Very Fine	1

Aluminum Oxide Large Flap Wheel Sander



Warranty: Manufacturer, 120 Day

- Flap wheel sander consists of a series of coated abrasive pieces (forming the spokes of the wheel) which are mounted around a steel hub
- Delivers smooth, chatter-free grinding
- Used on bench grinder, stand grinder, or straight grinder with 25.4 mm (1 in) spindle
- Material: aluminum oxide

NOTE:

Wheel should be operated in direction of arrow. Never exceed maximum operating speed (RPM).

Part Number	Size	Grit	Max. Speed (RPM)	Package Quantity
262-9739	6 in x 1 in	120	6000	1

1/4 Inch Shank Abrasive Flap Wheels



Warranty: Manufacturer, 120 Day

- Aluminum-oxide coated abrasive flaps with cloth backing
- Delivers smooth, chatter-free grinding
- Use with handheld grinders
- Mounted on 6.35 mm (.25 in) shank
- Available in five popular grits and three sizes

Part Number	Diameter x Thickness	Grit	Package Quantity
254-5321	25.4 x 25.4 mm (1 x 1 in)	60	10
254-5322	25.4 x 25.4 mm (1 x 1 in)	80	10
254-5323	25.4 x 25.4 mm (1 x 1 in)	120	10

Abrasives — Wheels

1/4 Inch Shank Abrasive Flap Wheels (Cont'd.)

Part Number	Diameter x Thickness	Grit	Package Quantity
254-5324	25.4 x 25.4 mm (1 x 1 in)	180	10
254-5325	25.4 x 25.4 mm (1 x 1 in)	240	10
254-5326	50.8 x 25.4 mm (2 x 1 in)	60	10
254-5327	50.8 x 25.4 mm (2 x 1 in)	80	10
254-5328	50.8 x 25.4 mm (2 x 1 in)	120	10
254-5329	50.8 x 25.4 mm (2 x 1 in)	180	10
254-5330	50.8 x 25.4 mm (2 x 1 in)	240	10
254-5331	76.2 x 25.4 mm (3 x 1 in)	60	10
254-5332	76.2 x 25.4 mm (3 x 1 in)	80	10
254-5333	76.2 x 25.4 mm (3 x 1 in)	120	10
254-5334	76.2 x 25.4 mm (3 x 1 in)	180	10
254-5335	76.2 x 25.4 mm (3 x 1 in)	240	10

Zirconium Raised Hub Wheels



Warranty: Manufacturer, 120 Day

- Designed for rough grinding applications, including:
 - grinding/smoothing weld seams
 - cleaning metal surfaces
- Designed for use on electrical or air powered right angle or vertical shaft grinders
- Wheels fit 114.3 mm, 177.8 mm and 228.6 mm (4 1/2 in, 7 in and 9 in) grinders
- Type 28 wheels have built-in 15° angle for out of position work
- Wheels comply with ANSI safety code B-7.1
- 1/4 - inch (6 mm) thick

Part Number	Package Quantity	Grit	Dimensions	Thread Size	Max. Speed (RPM)
Type 27					
4C-3769	5	A24	7 inch (177 mm)	7/9	8,500
4C-3770	5	A24	7 inch (177 mm)	5/9 - 11	8,500
4C-3772	5	A24	9 inch (228 mm)	5/9 - 11	6,600
9U-6383	1	A24	5 inch (127 mm)	5/9 - 11	12,220
Type 28 (built-in 15 degree angle)					
4C-3773	5	A24	7 inch (177 mm)	7/8	8,500
4C-3774	5	A24	7 inch (177 mm)	5/9 - 11	8,500
4C-3776	5	A24	9 inch (228 mm)	5/9 - 11	6,600

Aluminum Oxide Raised Hub Wheels



Warranty: Manufacturer, 120 Day

- Designed for use on electrical or air powered right angle or vertical shaft grinders
- Designed for rough grinding applications, including:
 - grinding/smoothing weld seams
 - cleaning metal surfaces
- Wheels fit 114.3 mm, 177.8 mm and 228.6 mm (4 1/2 in, 7 in and 9 in) grinders
- Type 28 wheels have built-in 15° angle for out of position work
- Wheels comply with ANSI safety code B-7.1

Part Number	Package Quantity	Grit	Dimensions	Thread Size	Max. Speed (RPM)
Type 27					
1U-6788	10	A24	102 x 3 mm (4 x 1/8 in)	5/8	15,300
1U-6789	10	A24	102 x 6 mm (4 x 1/4 in)	5/8	15,300
1U-6790	10	A24	114 x 3 mm (4 1/2 x 1/8 in)	7/8	13,300
1U-6791	10	A24	114 x 6 mm (4 1/2 x 1/4 in)	7/8	13,300
1U-6792	10	A24	177 x 3 mm (7 x 1/8 in)	7/8	8,500
1U-6793	10	A24	177 x 6 mm (7 x 1/4 in)	7/8	8,500
1U-6794	10	A24	177 x 6 mm (7 x 1/4 in)	5/8 - 11	8,500
1U-6796	10	A24	228 x 6 mm (9 x 1/4 in)	5/8 - 11	6,600
236-8061	Bulk	A24	152 x 6 mm (6 x 1/4 in)	7/8	10,000
9U-6382	1	A24	127 x 6 mm (5 x 1/4 in)	5/8 - 11	12,220
Type 28 (built-in 15 degree angle)					
4C-3863	10	A24	228 x 6.35 mm (9 x 1/4 in)	5/8 - 11	6,600

Cut-Off Wheels



Warranty: Manufacturer, 120 Day

- Fully reinforced cut-off wheels for heavy-duty cut off jobs on ferrous metals
- Wheels comply with ANSI Safety Code B-7.1
- Use A60 for burr-free, cool cutting of metal
- Use A36 for rough cutting applications
- Offers quality at a competitive price

Part Number	Package Quantity	Grit	Dimensions	Hole Size	Max. Speed (RPM)
3- inch / 25,000 RPM					
174-8900	25	A60	76 x 1 mm (3 x 1/32 in)	1/4 in	25,000
174-8901	25	A60	76 x 1.5 mm (3 x 1/16 in)	3/8 in	25,000
174-8902	25	A36	76 x 1.5 mm (3 x 1/16 in)	1/4 in	25,000
174-8903	25	A36	76 x 3 mm (3 x 1/8 in)	3/8 in	25,000

Abrasives — Wheels

Cut-Off Wheels (Cont'd.)

Part Number	Package Quantity	Grit	Dimensions	Hole Size	Max. Speed (RPM)
174-8904	25	A36	76 x 3 mm (3 x 1/8 in)	3/8 in	25,000
174-8905	25	A36	76 x 1 mm (3 x 1/32 in)	1/4 in	25,000
4 - inch / 20,000 RPM					
174-8906	25	A60	101 x 1 mm (4 x 1/32 in)	1/4 in	20,000
174-8907	25	A60	101 x 1 mm (4 x 1/32 in)	3/8 in	20,000
174-8908	25	A36	101 x 1.5 mm (4 x 1/16 in)	1/4 in	20,000
174-8909	25	A36	101 x 1.5 mm (4 x 1/16 in)	3/8 in	20,000
174-8910	25	A36	101 x 3 mm (4 x 1/8 in)	1/4 in	20,000
174-8911	25	A36	101 x 3 mm (4 x 1/8 in)	3/8 in	20,000
Below 6,000 RPM					
1U-6809	25	A36	304 x 3 mm (12 x 7/64 in)	1 in	5,100
1U-6810	25	A36	356 x 3 mm (14 x 7/64 in)	1 in	4,400
1U-6811	10	A24	406 x 3 mm (16 x 5/32 in)	1 in	3,000

Thin Cut Abrasive Cutting Wheels



Warranty: Manufacturer, 120 Day

- High quality treated grain for long life
- Ideal for sheet metal, steel tubing, and solid stock
- Great for cutting off bolts and rusted fasteners
- Used on portable angle grinders
- Available in 1/32 and 1/16 inch thickness for fast cutting

Part Number	Size	Grade	Max. Speed (RPM)	Package Quantity
236-8066	114.3 mm x .889 mm x 22.23 mm (4 1/2 in x .035 in x 7/8 in)	A60	17,902	Bulk
236-8067	127 mm x .889 mm x 22.23 mm (5 in x .035 in x 7/8 in)	A60	12,223	Bulk
236-8068	152.4 mm x .889 mm x 22.23 mm (6 in x .035 in x 7/8 in)	A60	10,186	Bulk

Drill Sharpening Wheels (Type 1)



Warranty: Manufacturer, 120 Day

- Used on drill sharpening machines to form or sharpen drills
- Use aluminum oxide for all types of steel
- Use silicone carbide for tungsten carbide, non-ferrous metals such as brass, bronze and aluminum

Part Number	Grit Spec.	Wheel Size (O.D. x Thickness x I.D.)	Package Quantity
4C-3766	A80-H Aluminum Oxide	152.4 mm x 19 mm x 15.88 mm (6 in x 3/4 in x 5/8 in)	1
4C-3768 ⁽¹⁾	C80-I Silicon Carbide	152.4 mm x 19 mm x 15.88 mm (6 in x 3/4 in x 5/8 in)	1

Mandrel for Small Abrasive Wheels



Warranty: Manufacturer, 120 Day

- Simple, quick change design
- Used with small cut-off wheels with either a 1/4 inch or 3/8 inch hole
- Not recommended for wheels thicker than 1/8 inch
- Safe to use in die grinders up to 30,000 RPM
- Flush head for confined work
- Stress relieved, high tensile steel
- Includes two screws, one for 1/4 inch and one for 3/8 inch holes

Part Number	Description	Dimensions	Package Quantity
236-8038	Mandrel	2 inch OAL x 1/4 inch shank	1

¹ Used to sharpen cobalt or carbide drill bits and tools

Abrasives — Wheels

Portable Wheels — Reinforced (Type 1)



Warranty: Manufacturer, 120 Day

- These reinforced wheels are to be used on grinders to clean up and blend
- Straight wheels are to be used on portable horizontal shaft or straight shaft machines

Part Number	Grit Spec.	Max. Speed (RPM)	Wheel Size (O.D. x Thickness x I.D.)	Package Quantity
4C-3777	A36	27,120	50.8 mm x 12.7 mm x 9.53 mm (2 in x 1/2 in x 3/8 in)	10
4C-3864	A24	27,120	50.8 mm x 12.7 mm x 9.53 mm (2 in x 1/2 in x 3/8 in)	10
4C-3865	A36	18,080	76.2 mm x 9.53 mm x 9.53 mm (3 in x 3/8 in x 3/8 in)	10

Bench and Pedestal Wheels (Type 1)



Warranty: Manufacturer, 120 Day

- Cover a broad range of general bench grinding jobs
- Offer custom quality
- Choose aluminum oxide wheels for all types of steel
- 6-inch and 7-inch wheels come with 1/2", 5/8", 3/4" reduction bearings
- 8-inch wheels come with 5/8" and 3/4" reduction bearings
- 10-inch wheels come with 3/4" and 1" reduction bearings

Part Number	Grit Spec.	Max. Speed (RPM)	Wheel Size (O.D. x Thickness x I.D.)	Package Quantity
1U-6784	A36	3,600	177.8 mm x 25.4 mm x 25.4 mm (7 in x 1 in x 1 in)	1
1U-6786	A36	3,600	203.2 mm x 25.4 mm x 25.4 mm (8 in x 1 in x 1 in)	1
1U-6787	A60	3,600	203.2 mm x 25.4 mm x 25.4 mm (8 in x 1 in x 1 in)	1
1U-8285	A36	2,485	254 mm x 25.4 mm x 31.75 mm (10 in x 1 in x 1 1/4 in)	1
1U-8286	A60	2,485	254 mm x 25.4 mm x 31.75 mm (10 in x 1 in x 1 1/4 in)	1

Aluminum Oxide Flaring Cup Snagging Wheels (Type 11)



1U-6817

Warranty: Manufacturer, 120 Day

- Use on right angle or vertical machines
- Use for grinding welds, cleaning castings, or grinding fins and parting lines from rough castings
- Use for smoothing of weld seams and metal preparations prior to plating/painting

Part Number	Grit Spec.	Max. Speed (RPM)	Large O.D. / Small O.D. x Thickness x I.D.	Package Quantity
1U-6817	A16	9,075	101.6/76.2 mm x 50.8 mm x 5/8 in-11 (4/3 in x 2 in x 5/8 in-11)	10
1U-6818	A16	7,260	127/95.3 mm x 50.8 mm x 5/8 in-11 (5/3 3/4 in x 2 in x 5/8 in-11)	10
1U-6819	A16	6,000	152.4/120.7 mm x 50.8 mm x 5/8 in-11 (6/4 3/4 in x 2 in x 5/8 in-11)	5

Mandrel #936



Warranty: Manufacturer, 120 Day

Part Number	Package Quantity	Maximum Operating Speed
8T-7768	5	22,000

Abrasives — Miscellaneous

Abrasive Hand Pads



4C-4175

Warranty: Manufacturer, 120 Day

- Every workplace has uses for non-woven nylon abrasive hand pads—whenever surfaces must be conditioned or cleaned by hand
- Used to clean surfaces or remove rust, oxides, paint discoloration, and other surface contaminants
- Impart and blend cosmetic finishes on metal or highlight wood finishes
- Hand deburr metals and plastics quickly and economically
- Used with optional 4C-4175 Hand Pad Holder
- Size: 152 x 229 mm (6 x 9 in)

Part Number	Description	Grade	Color	Package Quantity
8T-7752	Long Life Production	Coarse	Black	20
262-9980	Heavy-Duty Aggressive	Extra Coarse	Tan	20
241-9512	Cleaning and Finishing	Fine	Gray	20
8T-7765	General Purpose	Medium	Green	20
8T-7751	Medium-Duty Cleaning	Medium	Maroon	20
4C-4175	Pad Holder	—	—	—

Aluminum Oxide Cutting and Polishing Rolls

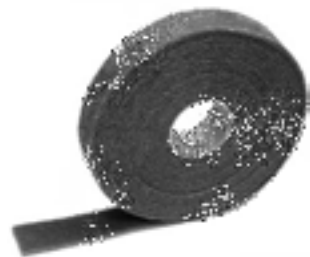

Warranty: Cat Standard Warranty, 6 Months

- A unique and aggressive material for cleaning, finishing deburring
- Ideal as a utility bench roll
- Used in similar application as Emery Rolls, but does not load up with material

Details	
Mineral type	Aluminum oxide
Color	Tan
Grade	Very fine, medium

Part Number	Package Quantity	Size	Grade	Used with
1U-5512	1	25.4 mm x 9 m (1 in x 30 ft)	Very Fine	Hand application or hand drill with 8T-7766 mandrel
1U-5513	1	25.4 mm x 9 m (1 in x 30 ft)	Medium	Hand application or hand drill with 8T-7766 mandrel
1U-5514	1	51 mm x 9 m (2 in x 30 ft)	Very Fine	Hand application or hand drill with 8T-7766 mandrel
1U-5515	1	51 mm x 9 m (2 in x 30 ft)	Medium	Hand application or hand drill with 8T-7766 mandrel

Adapter Mandrel #935



Warranty: Manufacturer, 30 Day

- Tear off strip and insert in the mandrel to use in corners and other hard to reach areas
- Use on air drills

Part Number	Maximum Operating Speed	Package Quantity
8T-7766	6000 RPM with 25.4 x 38.1 mm (1 in x 1 1/2 in) flat stock (roll or hand pad)	5

Polishing Stone



Warranty: Cat Standard Warranty, 6 Months

- Use this fine grade polishing stone to remove the sharp, raised edges of nicks and burrs on machine components
- More useful than the emery paper where a burr or raised edge is large
- Should always be used with a lightweight oil

Part Number	Dimensions	Package Quantity
6V-2010	100 mm x 25 mm x 6 mm (4 in x 1 in x .25 in)	1

Sanding Cloth Rolls



Warranty: Manufacturer, 120 Day

- These cloth shop rolls are cut in various widths and can be torn to the desired length for hand deburring
- For contour sanding, stripping, deburring, rust removal, cutdown prior to polishing, and all general maintenance work

Part Number	Grit	Dimensions	Package Quantity
1- inch			
262-9732	180J	25 mm x 45.7 m (1 in x 50 yd)	1
262-9737	320J	25 mm x 45.7 m (1 in x 50 yd)	1
262-9740	400J	25 mm x 45.7 m (1 in x 50 yd)	1
269-7255	80J	25 mm x 45.7 m (1 in x 50 yd)	1
269-7256	100J	25 mm x 45.7 m (1 in x 50 yd)	1
269-7257	120J	25 mm x 45.7 m (1 in x 50 yd)	1
269-7258	220J	25 mm x 45.7 m (1 in x 50 yd)	1
269-7259	280J	25 mm x 45.7 m (1 in x 50 yd)	1
269-7260	500J	25 mm x 45.7 m (1 in x 50 yd)	1
1 1/2 - inch			
1U-6848	60J	38.1 mm x 45.7 m (1 1/2 in x 50 yd)	1
1U-6849	80J	38.1 mm x 45.7 m (1 1/2 in x 50 yd)	1
1U-6850	120J	38.1 mm x 45.7 m (1 1/2 in x 50 yd)	1
1U-6851	180J	38.1 mm x 45.7 m (1 1/2 in x 50 yd)	1

Abrasives — Miscellaneous

Sanding Cloth Rolls (Cont'd.)

Part Number	Grit	Dimensions	Package Quantity
1U-6852	240J	38.1 mm x 45.7 m (1 1/2 in x 50 yd)	1
1U-6853	320J	38.1 mm x 45.7 m (1 1/2 in x 50 yd)	1
4C-8522	80	38.1 mm x 22.7 m (1 1/2 in x 25 yd)	1
4C-8523	120	38.1 mm x 22.7 m (1 1/2 in x 25 yd)	1
4C-8524	180	38.1 mm x 22.7 m (1 1/2 in x 25 yd)	1
2 – inch			
1U-8274	60J	50.8 mm x 45.7 m (2 in x 50 yd)	1
1U-8275	80J	50.8 mm x 45.7 m (2 in x 50 yd)	1
1U-8276	100J	50.8 mm x 45.7 m (2 in x 50 yd)	1
1U-8277	120J	50.8 mm x 45.7 m (2 in x 50 yd)	1
1U-8278	180J	50.8 mm x 45.7 m (2 in x 50 yd)	1
1U-8279	240J	50.8 mm x 45.7 m (2 in x 50 yd)	1
1U-8280	320J	50.8 mm x 45.7 m (2 in x 50 yd)	1
262-9741	400J	50.8 mm x 45.7 m (2 in x 50 yd)	1

Sanding Sheets

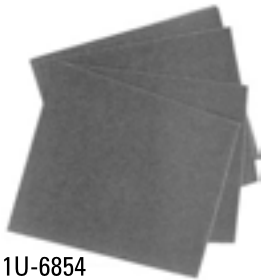

1U-6854

Warranty: Manufacturer, 120 Day

- These sheets are used for sanding and metal surface preparation
- Engineered for maximum economy, fast cutting and smoothing action
- Excellent for scouring, deburring, scale and rust removal

Part Number	Grit	Abrasive	Size	Package Quantity
266-3452	4/0	Emery	228.6 x 349.3 mm (9 in x 13.75 in)	100
1U-6854	60J	Aluminum Oxide	228.6 x 279.4 mm (9 in x 11 in)	25
1U-6855	80J	Aluminum Oxide	228.6 x 279.4 mm (9 in x 11 in)	25
1U-6856	120J	Aluminum Oxide	228.6 x 279.4 mm (9 in x 11 in)	50
1U-6857	180J	Aluminum Oxide	228.6 x 279.4 mm (9 in x 11 in)	50
1U-6858	240J	Aluminum Oxide	228.6 x 279.4 mm (9 in x 11 in)	50
1U-6859	320J	Aluminum Oxide	228.6 x 279.4 mm (9 in x 11 in)	50
1U-8281	400A	Silicon Carbide	228.6 x 279.4 mm (9 in x 11 in)	50
1U-8282	500A	Silicon Carbide	228.6 x 279.4 mm (9 in x 11 in)	50
1U-8283	600A	Silicon Carbide	228.6 x 279.4 mm (9 in x 11 in)	50
4C-8510	Crocus	Ferrous Oxide	228.6 x 279.4 mm (9 in x 11 in)	50

Surface Conditioning Belts



Warranty: Manufacturer, 120 Day

- Excellent tool to polish crankshafts
- Ideal for high tension applications
- Unique, reinforced construction delivers a uniform, consistent finish that can be applied with abrasive belt machinery
- Surface conditioning belts are reinforced which allows the material to be spliced into a continuous belt
- Open construction resists loading and heat buildup that normally affects belt life and performance
- As it wears, the surface conditioning material exposes fresh abrasive mineral to the work surface, providing consistent results throughout the belt's life
- Density: 5

Part Number	Package Quantity	Wheel Size	Maximum Operating Speed	Optimum Operating Speed	Grade	Color	Used with
6V-3044	12	25.4 mm x 165.1 cm (1 in x 65 in)	6500 SFPM	5500 SFPM	Fine	Blue	Abrasive belt machinery

Sanding Belts



Warranty: Manufacturer, 120 Day

- Used with any 7.62 x 53.34 cm (3 x 21 in) belt sander
- Material: aluminum oxide with cloth back

Part Number	Grade	Color
262-9742	36 grit - coarse	Tan
262-9743	80 grit - medium	Tan
262-9744	120 grit - fine	Tan
262-9745	220 grit - super fine	Tan

Aluminum Oxide Cleaning and Polishing Stars



Warranty: Manufacturer, 120 Day

- Perfect choice for cleaning and polishing the inside diameters of pipe, tubing, cylinders and other interior spaces
- Star shape allows the star tips to provide constant outward pressure on the walls to produce uniform and consistent results
- Can be mounted singly or in multiples for efficient inside diameter cleaning and polishing operations
- Adapter: 4C-8629 Mandrel

Abrasives — Miscellaneous

Aluminum Oxide Cleaning and Polishing Stars (Cont'd.)

Part Number	Package Quantity	Diameter	Maximum Operating Speed	Optimum Operating Speed
4C-8624	25	38.1 mm (1 1/2 in)	24,000	18,000
4C-8625	25	50.8 mm (2 in)	24,000	18,000
4C-8626	10	76.2 mm (3 in)	18,000	15,000
4C-8627	10	101.6 mm (4 in)	18,000	15,000
4C-8628	10	114.3 mm (4 1/2 in)	18,000	15,000
Mandrel				
4C-8629	—	—	—	—

Surface Reconditioning Flex-Hone Tools



1U-9787

Warranty: Manufacturer, 90 Day

- The flex-hone process (Superfinishing) produces a controlled surface condition that will result in:
 - Lowered oil consumption
 - Less blow-by
 - Less friction
 - Plateaued finish over 50%
 - Finish free from cut, and folded metal
- All abrasive is silicone carbide
- Resilient, flexible, honing tool with soft cutting action
- Abrasive (points) globules each have independent suspension that assures the hone to be self-centering, self-aligning to the bore, and self-compensating for wear
- A low temperature abrading process that exposes the undisturbed base metal structure to produce a long wearing surface
- Method of developing a surface on a metal part which is optically smooth and metallurgically free of any fragmented, amorphous or smeared metal from previous operations
- Accomplished at a low pressure where the "stones" float
- Hone crosshatch is extremely efficient in providing a multiplicity of oil grooves or valleys for oil retention as opposed to the uni-directional or uneven valleys common to the conventional type rigid hone. A crosshatch that usually remains as the cylinder wall has been wear-reduced by the hone.

Part Number	Package Quantity	Engine Bore Size	Grit
1U-7428	1	101.6 mm (4 in)	240
1U-9787	1	120.65-127 mm (4 3/4 in-5 in)	180
4C-6322	1	101.6 mm (4 in)	180
4C-6323	1	107.95 mm (4 1/4 in)	180
4C-6324	1	117.3 mm (4 1/2 in)	180
4C-6325	1	133.5-137.16 mm (5 1/4 in-5.4 in)	180

Surface Reconditioning Flex-Hone Tools (Cont'd.)

Part Number	Package Quantity	Engine Bore Size	Grit
4C-6326	1	146.05-152.4 mm (5 3/4 in-6 in)	180
4C-6327	1	158.75 mm (6 1/4 in)	180
4C-6328	1	169.92-177.8 mm (6.69 in-7 in)	180
4C-6329	1	190.5 mm (7 1/2 in)	180
4C-6330	1	203.2 mm (8 in)	180
4C-6331	1	241.3 mm (9 1/2 in)	180
4C-6332	1	60.33 mm (2 3/8 in)	240
4C-6333	1	79.38 mm (3 1/8 in)	240
4C-6334	1	92.08 mm (3 5/8 in)	240
4C-6335	1	104.78 mm (4 1/8 in)	240
4C-6336	1	114.3 mm (4 1/2 in)	240
4C-6337	1	12.7 mm (1/2 in)	320
4C-6338	1	15.88 mm (5/8 in)	320
4C-6339	1	19 mm (3/4 in)	320
4C-6340	1	25.4 mm (1 in)	320
4C-6341	1	38.1 mm (1 1/2 in)	320

Mounted Points

Warranty: Manufacturer, 120 Day

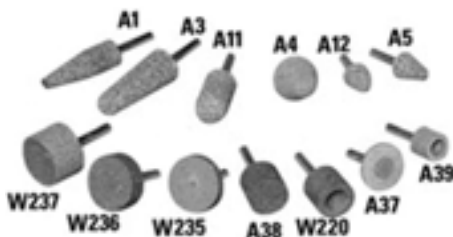

- Mounted wheels are used with horizontal or straight shaft, die and pencil grinders on jobs where larger wheels will not fit
- Offer maximum performance for grinding ferrous metals
- Accurate spindles ensure precision grinding and minimize run-out
- A-shaped wheels are for medium to heavy-duty blending and contouring
- W-shaped wheels are for off-hand and precision grinding of medium to heavy stock

Part Number	Shape	Grit Spec.	Diameter x Length	Max Speed	Mandrel Diameter	Package Quantity
1U-6820	A1	A36	19 mm x 63.5 mm (3/4 in x 2 1/2 in)	19,800	6.4 mm (1/4 in)	25
1U-6821	A1	A60	19 mm x 63.5 mm (3/4 in x 2 1/2 in)	19,800	6.4 mm (1/4 in)	25
1U-6822	A3	A36	25.4 mm x 69.85 mm (1 in x 2 3/4 in)	16,100	6.4 mm (1/4 in)	25
1U-6823	A3	A60	25.4 mm x 69.85 mm (1 in x 2 3/4 in)	16,100	6.4 mm (1/4 in)	25
1U-6824	A11	A36	22.23 mm x 50.8 mm (7/8 in x 2 in)	19,860	6.4 mm (1/4 in)	25
1U-6825	A11	A60	22.23 mm x 50.8 mm (7/8 in x 2 in)	19,860	6.4 mm (1/4 in)	25
1U-6826	A38	A60	25.4 mm x 25.4 mm (1 in x 1 in)	34,500	6.4 mm (1/4 in)	25
4C-3845	A4	A60	31.75 mm x 31.75 mm (1 1/4 in x 1 1/4 in)	30,560	6.4 mm (1/4 in)	25
4C-3846	A5	A36	19 mm x 28.58 mm (3/4 in x 1 1/8 in)	45,000	6.4 mm (1/4 in)	25
4C-3849	A12	A36	26.9 mm x 31.75 mm (11/16 in x 1 1/4 in)	48,000	6.4 mm (1/4 in)	25
4C-3850	A12	A60	26.9 mm x 31.75 mm (11/16 in x 1 1/4 in)	48,000	6.4 mm (1/4 in)	25
4C-3852	A39	A60	19 mm x 19 mm (3/4 in x 3/4 in)	47,250	6.4 mm (1/4 in)	25

Abrasives — Miscellaneous

Mounted Points (Cont'd.)

Part Number	Shape	Grit Spec.	Diameter x Length	Max Speed	Mandrel Diameter	Package Quantity
4C-3853	W220	A60	25.4 mm x 25.4 mm (1 in x 1 in)	20,250	6.4 mm (1/4 in)	25
4C-3854	W235	A60	38.1 mm x 6.35 mm (1 1/2 in x 1/4 in) (with hub)	25,460	6.4 mm (1/4 in)	25
4C-3855	W236	A60	38.1 mm x 12.7 mm (1 1/2 in x 1/2 in) (with hub)	25,460	6.4 mm (1/4 in)	25
4C-3856	W237	A60	38.1 mm x 25.4 mm (1 1/2 in x 1 in)	25,460	6.4 mm (1/4 in)	25
6V-4802	A37	A60	31.75 mm x 31.75 mm (1 1/4 in x 1 1/4 in) (with hub)	30,560	6.4 mm (1/4 in)	25

Threaded Cones and Plugs



Warranty: Manufacturer, 120 Day

- Use on horizontal shaft and vertical shaft grinders
- Choose these for welding shop jobs such as:
 - Grinding and smoothing fillets and corners
 - Internal grinding
 - Blending contours
 - Work in confined areas
- Center holes have molded-in bushings, available in 5/8 inch-11 threads to fit most popular grinder spindles

Available in four shapes:

- Type 16 with rounded tip for grinding mild contours or flat surfaces
- Type 17 with square tip for beveling workpiece edges prior to welding
- Type 18 square plugs for use on straight shaft grinders for work on flat surfaces
- Type 18R also called pot balls, for work requiring straight sides and rounded tips

Item	Part Number	Grit Spec.	O.D. x Length x Thread Size	Package Quantity
Type 16	1U-6812	A24	38.1 mm x 76.2 mm x 5/8 in-11 (1 1/2 in x 3 in x 5/8 in-11)	10
Type 17	1U-6813	A24	63.5 mm x 76.2 mm x 5/8 in-11 (2 1/2 in x 3 in x 5/8 in-11)	10
Type 18	1U-6814	A24	38.1 mm x 63.5 mm x 5/8 in-11 (1 1/2 in x 2 1/2 in x 5/8 in-11)	10
Type 18R	1U-6815	A24	38.1 mm x 63.5 mm x 5/8 in-11 (1 1/2 in x 2 1/2 in x 5/8 in-11)	10
Type 18R	1U-6816	A24	50.8 mm x 76.2 mm x 5/8 in-11 (2 in x 3 in x 5/8 in-11)	10

Carbide Burrs



Warranty: Manufacturer, 120 Day

- Ideally used on high speed die grinders for steel, iron and composites
- "Double cut" designed burrs provide rapid stock removal in tough applications
- Produces small chips
- A variety of shapes for most applications
- Excellent for grinding and shaping most metallic and non-metallic materials

Part Number	Size	Shape	Shank Size	Package Quantity
236-8093	9.53 mm x 15.88 mm (3/8 in x 5/8 in)	Egg	6.35 mm (1/4 in)	1
236-8094	9.53 mm (3/8 in)	Ball	6.35 mm (1/4 in)	1
236-8095	9.53 mm x 19 mm (3/8 in x 3/4 in)	Pointed Tree	6.35 mm (1/4 in)	1
236-8096	9.53 mm x 19 mm (3/8 in x 3/4 in)	Cylindrical	6.35 mm (1/4 in)	1
236-8097	9.53 mm x 19 mm (3/8 in x 3/4 in)	Round Nose	6.35 mm (1/4 in)	1
236-8098	9.53 mm x 26.99 mm (3/8 in x 11/16 in)	Cone Radius End	6.35 mm (1/4 in)	1
236-8100	3.18 mm x 14.29 mm (1/8 in x 9/16 in)	Flat End Cut	3.18 mm (1/8 in)	1
236-8101	3.18 mm x 14.29 mm (1/8 in x 9/16 in)	Round End	3.18 mm (1/8 in)	1
262-9746	6.35 mm x 19 mm (1/4 in x 3/4 in)	Cylindrical	6.35 mm (1/4 in)	1
262-9747	12.7 mm x 25.4 mm (1/2 in x 1 in)	Cylindrical	6.35 mm (1/4 in)	1
262-9748	6.35 mm x 19 mm (1/4 in x 3/4 in)	Cylindrical	6.35 mm (1/4 in)	1

Aluma Cut Carbide Burrs



Warranty: Manufacturer, 120 Day

- For use with aluminum non-ferrous metals and non-metallic materials
- Wide clearance and end mill type geometry of the flutes promotes fast stock removal with minimum loading
- Material: tungsten carbide

Part Number	Size	Shape	Package Quantity
236-8104	9.53 mm x 19 mm (3/8 in x 3/4 in)	Cylindrical	1

Spira Bands

4C-3778

4C-3782



Warranty: Manufacturer, 120 Day

- Ideal for grinding, blending, deburring, finishing and polishing flat and contoured surfaces
- Design eliminates lap bumping marks, provides chatter free operation
- Good alternative tools for flap wheels

Abrasives — Miscellaneous

Spira Bands (Cont'd.)

Part Number	Grit	Size	Package Quantity
Mandrels			
4C-3778	60	19 mm x 25.4 mm (3/4 in x 1 in)	1
4C-3779	60	25.4 mm x 25.4 mm (1 in x 1 in)	1
4C-3780	60	38.1 mm x 38.1 mm (1 1/2 in x 1 1/2 in)	1
4C-3781	60	50.8 mm x 25.4 mm (2 in x 1 in)	1
4C-3782	Mandrel 1/4 in	19 mm x 25.4 mm (3/4 in x 1 in)	1
4C-3783	Mandrel 1/4 in	25.4 mm x 25.4 mm (1 in x 1 in)	1
4C-3784	Mandrel 1/4 in	38.1 mm x 38.1 mm (1 1/2 in x 1 1/2 in)	1
4C-3785	Mandrel 1/4 in	50.8 mm x 25.4 mm (2 in x 1 in)	1

Screen-Bak Durite Rolls



Warranty: Manufacturer, 120 Day

- Use for superfast makeready of copper pipe joints
- Removes scale, corrosion and oxidations without clogging — sanding residue falls through the backing
- Long abrasive life and clean, tight connections are ensured
- Silicon carbide abrasive grain is coated on both sides of an open weave, cloth backing

Part Number	Grit	Size
4C-8522	80	11/2 in x 25 ft
4C-8523	120	11/2 in x 25 ft
4C-8524	180	11/2 in x 25 ft

Decal Removal



- Fast and easy method to remove vinyl decals, graphics, tapes, films and adhesive without damaging paint – no fire damage because the discs are noncombustible.
- Unique construction of the disc assures long life and allows easy conformability to contours
- Discs are flexible and have no sharp edges – will not damage acrylic, enamel or urethane paint. (Not recommended for use on acrylic lacquer paints or plexiglass.)
- Faster and cleaner to use than solvent or chemical adhesive removers
- RPM is critical for product performance – maximum RPM is 4000; recommended RPM is 3000 to 4000

Decal Removal (Cont'd.)

Part Number	Description	Package Quantity	Diameter	Shank Length	Used With
226-0125	Decal Removal Disc	1	120 mm x 15.9 mm (4 in x 5/8 in)	—	Electric or Air Drill
226-0126	Mandrel	1	25.4 mm x 44.5 mm (1 in x 3/4 in)	9 mm (0.35 in)	—

Nylon Cleaning Brushes

Warranty: Cat Standard Warranty, 6 Months

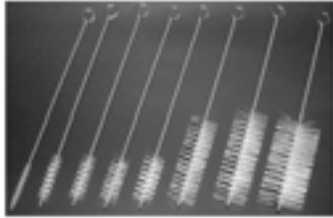

- Used in a variety of cleaning applications, such as spray paint equipment and parts washers for cleaning tubes, valves cylinders, etc.
- Nylon bristles clean dirt without damaging surface
- Available in several brush diameters to meet cleaning task requirements
- Nylon bristles with a 25 cm (10 in) metal handle
- Long handle for cleaning hard to reach dirt and debris

Part Number	Brush Diameter	Brush Length	Qty.
264-4352	50.8 mm (2 in)	102 mm (4 in)	48
264-4355	12.7 mm (1/2 in)	51 mm (2 in)	48
264-4357	19.0 mm (3/4 in)	51 mm (2 in)	48
264-4358	22.2 mm (7/8 in)	102 mm (4 in)	48
264-4372	38.1 mm (1 1/2 in)	102 mm (4 in)	48
266-2281	6.4 mm (1/4 in)	51 mm (2 in)	48
266-2282	15.9 mm (5/8 in)	51 mm (2 in)	48
266-2283	31.8 mm (1 1/4 in)	102 mm (4 in)	48

Tube Brush

Warranty: Cat Standard Warranty, 6 Months



Part Number	Package Quantity	Description	O.D.	Wire
4C-6161	1	76.2 mm (3 in) Brush Face, 609.6 mm (24 in) O.A.L.	9.53 mm (3/8 in)	.13 mm (.005 in), Carbon Steel

Brass Bristle Cleaning Brush



Warranty: Cat Standard Warranty, 6 Months

- Use to clean tire beads prior to mounting
- Also good for other applications where steel or nylon bristles will not work
- Foam plastic handle will not crack when left in cleaning solution
- Dense brass bristles clean well and will not rust

Abrasives — Miscellaneous

Brass Bristle Cleaning Brush (Cont'd.)

Part Number	Length x Width	Bristle Length	Package Quantity
262-4868	216 x 9 cm (8.5 x 3.5 in)	16 mm (.62 in)	12

Parts Cleaning Brush

Warranty: Cat Standard Warranty, 6 Months

- For general cleaning—works great in parts washers
- Will not rust or damage the surface of the part being cleaned
- All poly handle and ferrule with natural fiber bristles
- Tapered handle for better grip
- Long bristles reach hard to clean areas



Part Number	Diameter	Overall Length	Bristle Length	Package Quantity
264-4359	25 mm (1 in)	25 cm (10 in)	64 mm (2.5 in)	12

Standard Drill Bits



Warranty: Manufacturer, 120 Day

These roll forged jobber length drills are designed with a 118° point. Made with M-2 high speed steel. A dependable general purpose drill bit designed to perform in a broad range of materials in the iron and steel families. Ideal for production, maintenance, or portable drilling jobs. Surface treated with abrasion resistant black oxide.

Part Number	Size	Part Number	Size	Part Number	Size
1U-5889 Drill Bit Set (Plus Index), 13 Piece		1U-5600	15/64 in	1U-5593	1/8 in
1U-5589	1/16 in	1U-5601	1/4 in	1U-5594	9/64 in
1U-5590	5/64 in	1U-5602	17/64 in	1U-5595	5/32 in
1U-5591	3/32 in	1U-5603	9/32 in	1U-5596	11/64 in
1U-5592	7/64 in	1U-5604	19/64 in	1U-5597	3/16 in
1U-5593	1/8 in	1U-5605	5/16 in	1U-5598	13/64 in
1U-5594	9/64 in	1U-5606	21/64 in	1U-5599	7/32 in
1U-5595	5/32 in	1U-5607	11/32 in	1U-5600	15/64 in
1U-5596	11/64 in	1U-5608	23/64 in	1U-5601	1/4 in
1U-5597	3/16 in	1U-5609	3/8 in	1U-5602	17/64 in
1U-5598	13/64 in	1U-5610	25/64 in	1U-5603	9/32 in
1U-5599	7/32 in	1U-5611	13/32 in	1U-5604	19/64 in
1U-5600	15/64 in	1U-5612	27/64 in	1U-5605	5/16 in
1U-5601	1/4 in	1U-5613	7/16 in	1U-5606	21/64 in
1U-5714 Drill Bit Set (Plus Index), 29 Piece		1U-5614	29/64 in	1U-5607	11/32 in
1U-5589	1/16 in	1U-5615	15/32 in	1U-5608	23/64 in
1U-5590	5/64 in	1U-5616	31/64 in	1U-5609	3/8 in
1U-5591	3/32 in	1U-5617	1/2 in	1U-5610	25/64 in
1U-5592	7/64 in	Individual Drill Bits		1U-5611	13/32 in
1U-5593	1/8 in	1U-5586	1/64 in	1U-5612	27/64 in
1U-5594	9/64 in	1U-5587	1/32 in	1U-5613	7/16 in
1U-5595	5/32 in	1U-5588	3/64 in	1U-5614	29/64 in
1U-5596	11/64 in	1U-5589	1/16 in	1U-5615	15/32 in
1U-5597	3/16 in	1U-5590	5/64 in	1U-5616	31/64 in
1U-5598	13/64 in	1U-5591	3/32 in	1U-5617	1/2 in
1U-5599	7/32 in	1U-5592	7/64 in	1U-6700	19/64 in

Metal Cutting — Drill Bits

Reduced Shank Drill Bits



Warranty: Manufacturer, 120 Day

S & D drill bits, as they are often called, are designed with a 118° point. Made with M-2 high speed steel. Expands the size range capacity of a 1/2 portable drill chuck. Common flute and overall length for minimal adjustment during tool changes. Precision ground for high degree of concentricity between shank and body diameter. Ideal for drilling in low and medium tensile strength materials.

Part Number	Size
Individual Drill Bits	
1U-5682	17/32 in
1U-5683	9/16 in
1U-5684	19/32 in
1U-5685	5/8 in
1U-5686	21/32 in
1U-5687	1 1/16 in
1U-5688	23/32 in
1U-5689	3/4 in
1U-5690	25/32 in
1U-5691	13/16 in
1U-5692	27/32 in
1U-5693	7/8 in

Part Number	Size
Individual Drill Bits	
1U-5694	29/32 in
1U-5695	15/16 in
1U-5696	31/32 in
1U-5697	1 in
1U-5698	1 1/32 in
1U-5699	1 1/16 in
1U-5700	1 3/32 in
1U-5701	1 1/8 in
1U-5702	1 5/32 in
1U-5703	1 3/16 in
1U-5705	1 1/4 in

Part Number	Size
Individual Drill Bits	
1U-5707	1 5/16 in
1U-5709	1 3/8 in
1U-5711	1 7/16 in
1U-5713	1 1/2 in
1U-7433	33/64 in
1U-7434	37/64 in
1U-7435	45/64 in
1U-7436	53/64 in
1U-7437	1 9/16 in (3/4 inch Shank)
1U-7438	1 13/26 in (3/4 inch Shank)

Heavy-Duty Drill Bits, 135° Split Point



Warranty: Manufacturer, 120 Day

These drill bits are designed with a 135° split point for self centering and reducing thrust. Can reduce drill time by 50% compared to 118° point. Manufactured from premium M-2 grade high speed steel. Gold and black surface treated for use in stainless and other hard metal drilling. Sizes smaller than 1/16" have the 118° standard point.

Part Number	Size
1U-5892 Drill Bit Set (Plus Index), 13 Piece	
1U-5621	1/16
1U-5622	5/64
1U-5623	3/32
1U-5624	7/64
1U-5625	1/8
1U-5626	9/64
1U-5627	5/32

Part Number	Size
1U-5628	11/64
1U-5629	3/16
1U-5630	13/64
1U-5631	7/32
1U-5632	15/64
1U-5633	1/4
1U-5893 Drill Bit Set (Plus Index), 29 Piece	
1U-5621	1/16

Part Number	Size
1U-5622	5/64
1U-5623	3/32
1U-5624	7/64
1U-5625	1/8
1U-5626	9/64
1U-5627	5/32
1U-5628	11/64
1U-5629	3/16

Heavy-Duty Drill Bits, 135° Split Point (Cont'd.)

Part Number	Size	Part Number	Size	Part Number	Size
1U-5630	13/64	1U-5647	15/32	1U-5633	1/4
1U-5631	7/32	1U-5648	31/64	1U-5634	17/64
1U-5632	15/64	1U-5649	1/2	1U-5635	9/32
1U-5633	1/4	Individual Drill Bits		1U-5636	19/64
1U-5634	17/64	1U-5620	3/64	1U-5637	5/16
1U-5635	9/32	1U-5621	1/16	1U-5638	21/64
1U-5636	19/64	1U-5622	5/64	1U-5639	11/32
1U-5637	5/16	1U-5623	3/32	1U-5640	23/64
1U-5638	21/64	1U-5624	7/64	1U-5641	3/8
1U-5639	11/32	1U-5625	1/8	1U-5642	25/64
1U-5640	23/64	1U-5626	9/64	1U-5643	13/32
1U-5641	3/8	1U-5627	5/32	1U-5644	27/64
1U-5642	25/64	1U-5628	11/64	1U-5645	7/16
1U-5643	13/32	1U-5629	3/16	1U-5646	29/64
1U-5644	27/64	1U-5630	13/64	1U-5647	15/32
1U-5645	7/16	1U-5631	7/32	1U-5648	31/64
1U-5646	29/64	1U-5632	15/64	1U-5649	1/2

Extra Heavy-Duty Cobalt Drill Bits, 135° Split Point



Warranty: Manufacturer, 120 Day

These drill bits are designed with a 135° split point for self centering and reducing thrust. Can reduce drill time by 50% compared to 118° point. Made of high resistant M 42 cobalt. They display higher red hardness which permits speeds up to 30% greater than high speed drills. Cobalt drills are especially effective in drilling tough, high tensile strength materials like stainless steel, inconel, and titanium.

Part Number	Size	Part Number	Size	Part Number	Size
1U-5890 Drill Bit Set (Plus Index), 13 Piece		1U-5394	3/16 in	1U-5389	7/64 in
1U-5386	1/16 in	1U-5395	13/64 in	1U-5390	1/8 in
1U-5387	5/64 in	1U-5396	7/32 in	1U-5391	9/64 in
1U-5388	3/32 in	1U-5397	15/64 in	1U-5392	5/32 in
1U-5389	7/64 in	1U-5398	1/4 in	1U-5393	11/64 in
1U-5390	1/8 in	1U-5891 Drill Bit Set (Plus Index), 29 Piece		1U-5394	3/16 in
1U-5391	9/64 in	1U-5386	1/16 in	1U-5395	13/64 in
1U-5392	5/32 in	1U-5387	5/64 in	1U-5396	7/32 in
1U-5393	11/64 in	1U-5388	3/32 in	1U-5397	15/64 in

Metal Cutting — Drill Bits

Extra Heavy-Duty Cobalt Drill Bits, 135° Split Point (Cont'd.)

Part Number	Size	Part Number	Size	Part Number	Size
1U-5398	1/4 in	Individual Drill Bits		1U-5401	19/64 in
1U-5399	17/64 in	1U-5386	1/16 in	1U-5402	5/16 in
1U-5400	9/32 in	1U-5387	5/64 in	1U-5403	21/64 in
1U-5401	19/64 in	1U-5388	3/32 in	1U-5404	11/32 in
1U-5402	5/16 in	1U-5389	7/64 in	1U-5405	23/64 in
1U-5403	21/64 in	1U-5390	1/8 in	1U-5406	3/8 in
1U-5404	11/32 in	1U-5391	9/64 in	1U-5407	25/64 in
1U-5405	23/64 in	1U-5392	5/32 in	1U-5408	13/32 in
1U-5406	3/8 in	1U-5393	11/64 in	1U-5409	27/64 in
1U-5407	25/64 in	1U-5394	3/16 in	1U-5410	7/16 in
1U-5408	13/32 in	1U-5395	13/64 in	1U-5411	29/64 in
1U-5409	27/64 in	1U-5396	7/32 in	1U-5412	15/32 in
1U-5410	7/16 in	1U-5397	15/64 in	1U-5413	31/64 in
1U-5411	29/64 in	1U-5398	1/4 in	1U-5414	1/2 in
1U-5412	15/32 in	1U-5399	17/64 in	1U-8764	5/8 in (1/2 inch Shank)
1U-5413	31/64 in	1U-5400	9/32 in	1U-8765	3/4 in (1/2 inch Shank)
1U-5414	1/2 in				

Aircraft Drill Bits



Warranty: Manufacturer, 120 Day

These drill bits are designed with a 135° split point for self centering and reducing thrust. Made with M-2 high speed steel. Can reduce drill time by 50% compared to 118° point. Ground from solid, ideal for drilling in mild steel where extra length is required. They have a black oxide surface treatment that is abrasion resistant.

Part Number	Size
Individual Drill Bits (set not available)	
4C-4412	3/32 in
4C-4413	1/8 in
4C-4414	5/32 in
4C-4415	3/16 in
4C-4416	7/32 in
4C-4417	1/4 in
4C-4418	9/32 in
4C-4419	5/16 in
4C-4420	11/32 in
4C-4421	3/8 in
4C-4422	13/32 in
4C-4423	7/16 in
4C-4424	15/32 in
4C-4425	Drill, 1/2 in

Left Hand Drill Bits



Warranty: Manufacturer, 120 Day

These drill bits are designed with a 135° split point for self centering and reducing thrust. Made with M-2 high speed steel. Ground from solid features a left hand helix for screw machine applications and drilling out broken bolts.

- Index set not available

Part Number	Size
4C-3335	1/16 in
4C-3336	5/64 in
4C-3337	3/32 in
4C-3338	7/64 in
4C-3339	1/8 in
4C-3340	9/64 in
4C-3341	5/32 in
4C-3342	11/64 in
4C-3343	3/16 in
4C-3344	13/64 in

Part Number	Size
4C-3345	7/32 in
4C-3347	1/4 in
4C-3348	17/64 in
4C-3349	9/32 in
4C-3350	19/64 in
4C-3351	5/16 in
4C-3352	21/64 in
4C-3353	11/32 in
4C-3354	23/64 in

Part Number	Size
4C-3355	3/8 in
4C-3356	25/64 in
4C-3357	13/32 in
4C-3358	27/64 in
4C-3359	7/16 in
4C-3360	7/16 in
4C-3361	15/32 in
4C-3362	31/64 in
4C-3363	1/2 in

Metric Standard Drill Bits



Warranty: Manufacturer, 120 Day

These roll forged drill bits are designed with a 118° point. Made with M-2 high speed steel. A dependable general purpose drill designed to perform in a broad range of material in the iron and steel families. Ideal for production, maintenance, or portable drilling jobs.

Part Number	Size
1U-8122	1.20 mm
1U-8126	1.80 mm
1U-8133	2.50 mm
1U-8138	3.00 mm
1U-8142	3.60 mm
1U-8143	3.90 mm
1U-8144	4.00 mm
1U-8145	4.10 mm
1U-8146	4.30 mm
1U-8147	4.50 mm
1U-8151	5.00 mm

Part Number	Size
1U-8152	5.20 mm
1U-8153	5.50 mm
1U-8156	6.00 mm
1U-8157	6.50 mm
1U-8158	6.80 mm
1U-8159	7.00 mm
1U-8160	7.50 mm
1U-8161	8.00 mm
1U-8162	8.20 mm
1U-8163	8.50 mm
1U-8164	8.60 mm

Part Number	Size
1U-8165	8.70 mm
1U-8166	9.00 mm
1U-8167	9.50 mm
1U-8168	10.00 mm
1U-8169	10.50 mm
1U-8170	11.00 mm
1U-8171	11.50 mm
1U-8172	12.00 mm
1U-8173	12.20 mm
1U-8174	12.50 mm

Metal Cutting — Drill Bits

Drill Bit Index - 4C-3385



Warranty: Manufacturer, 120 Day

- Empty drill bit index for storing 29 different sizes of jobber length drill bits from 1/16 inch to 1/2 inch in 1/64 inch increments
- Typical use: left hand drill bits

Part Number	Description
4C-3385	Drill Bit Index

Drill Extension - 4C-4426



Warranty: Cat Standard Warranty, 6 Months

- Extends drill reach 304.8 mm (12 in)
- Accepts up to 1/4 inch diameter shank

Part Number	Description
4C-4426	Drill Extension

Recommended Drill Bit Sizes for Metric Thread

Warranty: Manufacturer, 120 Day

Thread Size	Drill Bit Diameter	Part Number	Thread Size	Drill Bit Diameter	Part Number
M1.6	1.4 mm	–	M6	5.2 mm	1U-8152
M2	1.7 mm	–	M8	7.0 mm	1U-8159
M2.5	2.2 mm	–	M10	8.7 mm	1U-8165
M3	2.6 mm	–	M12	10.5 mm	1U-8169
M4	3.4 mm	–	M14	12.2 mm	–
M5	4.3 mm	1U-8146	M20	18.0 mm	1U-8184

Abbreviations Used for Taps and Dies

NF	American National Fine Thread Series	PD	Pitch Diameters
NC	American National Coarse Thread Series	D5	Tolerance Limit of Ground Thread Metric Tap
NS	American National Thread — Special	D7	Tolerance Limit of Ground Thread Metric Tap
H1	Tolerance Limit of Ground Thread Tap	D9	Tolerance Limit of Ground Thread Metric Tap
H2	Tolerance Limit of Ground Thread Tap	NPT	National Standard Pipe Form
H3	Tolerance Limit of Ground Thread Tap	NPTT	American Standard Dryseal Pipe Form

Hand Taps

Warranty: Manufacturer, 120 Day

- Made of high speed M-7 steel for longer life
- These are ground thread taps providing tolerance designed for Class 2 Thread, exceeds quality of carbon steel taps
- Offered in tapered, plug and bottoming versions

Caterpillar offers five types of hand taps, available by individual part numbers and in sets (indexes).

- Machine screw
- Fractional
- Taper pipe
- Special thread taps
- Metric

Nominal Size (in)	Threads/Inch	Pitch Diameter Limits	Number of Flutes	Taper	Plug	Bottoming	Thread Length	Overall Length
3	56 NF	H2	3	—	1P-3007	—	1/2 in	1 13/16 in
4	40 NC	H2	3	4C-5008	1P-3008	4C-5015	9/16 in	1 7/8 in
5	40 NC	H2	3	—	1P-3010	—	5/8 in	1 15/16 in
6	32 NC	H3	3	4C-5009	1P-3012	4C-5016	11/16 in	2 in
8	32 NC	H3	4	4C-5010	1P-3014	4C-5017	3/4 in	2 1/8 in
8	36 NF	H2	4	—	1P-3015	—	3/4 in	2 1/8 in
10	24 NC	H3	4	4C-5011	1P-3016	4C-5018	7/8 in	2 3/8 in
10	32 NF	H3	4	4C-5012	1P-3017	4C-5019	7/8 in	2 3/8 in
12	24 NC	H3	4	4C-5013	1P-3018	4C-5020	15/16 in	2 3/8 in
12	28 NC	H3	4	4C-5014	1P-3019	4C-5021	15/16 in	2 3/8 in

Metal Cutting — Taps and Dies

Machine Screw Set - 1P-3020



Warranty: Manufacturer, 120 Day

- Contains plug taps from 0-80 through 12-28 in National Fine and 1-64 through 12-24 in National Coarse Threads
- Includes plastic index

Nominal Size (in)	Threads/Inch	Pitch Diameter Limits	Number of Flutes	Taper	Plug	Description	Bottoming	Thread Length	Overall Length
—	—	—	—	—	1P-3020	Complete Machine Screw Set	—	—	—
Machine Screw Set Consists of:									
1	12 NF	H4	4	4C-5006	1P-3040	Taps and Dies	4C-4988	2 1/2 in	5 1/8 in
1	14 NF	H4	4	4C-5007	1P-7421	—	5P-3011	2 1/2 in	5 1/8 in
1	8 NC	H4	4	4C-5005	1P-3039	Taps and Dies	4C-4987	2 1/2 in	5 1/8 in
1 1/16	12 NF	H4	4	—	1U-6539	Taps and Dies	—	2 1/2 in	5 1/8 in
1 1/2	12 NF	H4	6	—	1P-3044	—	—	3 in	6 3/8 in
1 1/4	12 NF	H4	6	—	1P-3042	—	—	2 9/16 in	5 3/4 in
1 1/4	7 NC	—	—	—	4C-5051	Plug Tap 1 1/4-7-2B	—	1 1/4 in	—
1 1/8	12 NF	H4	4	—	1P-3041	Taps and Dies	5P-3012	2 9/16 in	5 7/8 in
1 1/8	7 NC	—	4	—	1U-9707	Plug Tap 1 1/8-7-2B	—	2 1/2 in	5.4 in
1 3/8	12 NF	H4	6	—	1P-3043	Taps and Dies	5P-3013	3 in	6 1/16 in
1 3/8	6 NC	—	—	—	1U-9709	Plug Tap 1 3/8-6-2B	—	—	—
1 5/16	12 NF	H4	6	—	1U-6540	Taps and Dies	—	2 9/16 in	5 3/4 in
1/2	13 NC	H3	4	4C-4997	1P-3029	Taps and Dies	4C-4979	1 21/32 in	3 3/8 in
1/2	20 NF	H3	4	4C-4998	1P-3030	Taps and Dies	4C-4980	1 21/32 in	3 3/8 in
1/4	20 NC	H3	4	4C-4989	1P-3021	Taps and Dies	4C-4971	1 in	2 1/2 in
1/4	20 NF	H3	4	4C-4990	1P-3022	Taps and Dies	4C-4972	1 in	2 1/2 in
2 1/2 in	12 NC	H6	6	199-3947 ⁽¹⁾	199-3947 ⁽²⁾	Taper	—	3 in	7 in
3/4	10 NC	H3	4	4C-5001	1P-3035	Taps and Dies	4C-4983	2 in	4 1/4 in
3/4	12 NF	—	—	—	2B-2526	Taps and Dies	—	—	—
3/4	16 NF	H3	4	4C-5002	1P-3036	Taps and Dies	4C-4984	2 in	4 1/4 in
3/8	16 NC	H3	4	4C-4993	1P-3025	Taps and Dies	4C-4975	1 1/4 in	2 15/16 in
3/8	20 NF	H3	4	4C-4994	1P-3026	Taps and Dies	4C-4976	1 1/4 in	2 15/16 in
5/16	18 NC	H3	4	4C-4991	1P-3023	Taps and Dies	4C-4973	1 1/8 in	2 23/32 in
5/16	24 NF	H3	4	4C-4992	1P-3024	Taps and Dies	4C-4974	1 1/8 in	2 23/32 in
5/8	11 NC	H3	4	4C-4999	1P-3033	Taps and Dies	4C-4981	1 13/16 in	3 13/16 in
5/8	18 NF	H3	4	4C-5000	1P-3034	Taps and Dies	4C-4982	1 13/16 in	3 13/16 in
7/16	14 NC	H3	4	4C-4995	1P-3027	Taps and Dies	4C-4977	1 7/16 in	3 5/32 in
7/16	20 NF	H3	4	4C-4996	1P-3028	Taps and Dies	4C-4978	1 7/16 in	3 5/32 in
7/8	14 NF	H4	4	4C-5004	1P-3038	Taps and Dies	4C-4986	2 7/32 in	4 11/16 in
7/8	9 NC	H4	4	4C-5003	1P-3037	Taps and Dies	4C-4985	2 7/32 in	4 11/16 in
9/16	12 NC	H3	4	—	1P-3031	Taps and Dies	—	1 21/32 in	3 19/32 in

1 Warranty: Caterpillar, Six Months

2 Not available for individual sale

Machine Screw Set - 1P-3020 (Cont'd.)

Nominal Size (in)	Threads/Inch	Pitch Diameter Limits	Number of Flutes	Taper	Plug	Description	Bottoming	Thread Length	Overall Length
9/16	14 NF	—	—	—	2B-9256 ⁽³⁾	Taps and Dies	—	1 21/32 in	—
9/16	18 NF	H3	4	—	1P-3032	Taps and Dies	—	1 21/32 in	3 19/32 in

Fractional Size Tap Set - 1P-3070

- Contains 10 plug taps
- Includes plastic index



Nominal Size (inch)	Threads Per Inch
1/4	20 NC
1/4	28 NF
5/16	18 NC
5/16	24 NF
3/8	16 NC
3/8	24 NF
7/16	14 NC
7/16	20 NF
1/2	13 NC
1/2	20 NF

Part Number	Description
1P-3070	Fractional Size Tap Set

Fractional Size Tap Set - 1P-3050

Warranty: Manufacturer, 120 Day

- Contains 20 plug taps
- Includes 1P-3047 and 1P-3048 Tap Wrenches



Nominal Size (inch)	Threads Per Inch	Nominal Size (inch)	Threads Per Inch	Nominal Size (inch)	Threads Per Inch
1/4	20 NC	7/16	14 NC	5/8	11 NC
1/4	28 NF	7/16	20 NF	5/8	18 NF
5/16	18 NC	1/2	13 NC	3/4	10 NC
5/16	24 NF	1/2	20 NF	3/4	16 NF
3/8	16 NC	9/16	12 NC	7/8	9 NC
3/8	24 NF	9/16	18 NF	7/8	14 NF

³ Not available for individual sale

Metal Cutting — Taps and Dies

Fractional Size Tap Set - 1P-3050 (Cont'd.)

Nominal Size (inch)	Threads Per Inch	Nominal Size (inch)	Threads Per Inch
1	8 NC	1	14 NF

Part Number	Description
1P-3050	Fractional Size Tap Set
Fractional Size Tap Set Includes:	
1P-3047	Solid Handle Tap Wrench
1P-3048	Solid Handle Tap Wrench

Special Thread Taps

Warranty: Manufacturer, 120 Day

- Used for cleaning up damaged threads
- Not readily obtainable on the market because the threads are not common standards

Part Number	Size	Part Number	Size
1P-7422	2 inch-12 UN	1U-9708	1 1/4 inch-7 Spiralock
1U-6600	1 1/8 inch-7 Spiralock	5P-3012	1 1/8 inch-12 NF Bottom
1U-6725	1 3/8 inch-12 Buttress Bottoming Tap ⁽⁴⁾	6V-2091	3/8 inch-16 Spiralock ⁽⁴⁾
1U-6726	1 3/4 inch-12 Buttress Bottoming Tap ⁽⁴⁾	7S-7093	7/8 inch-12 UN

Rethreading Dies

- Caterpillar offers three types of rethreading dies, available by individual part number and in sets (indexes).
- Used to clean-up existing thread—not recommended to cut new threads
- Made of conventional carbon steel (unless otherwise specified)
- Conform to industry standards

Hexagon Rethreading Fractional Die Set - 1P-3000



Warranty: Manufacturer, 120 Day

- Contains 10 fractional, coarse thread dies
- Contains 10 fractional, fine thread dies
- Includes plastic index

⁴ Warranty: Caterpillar, Six Months

Hexagon Rethreading Fractional Die Set - 1P-3000 (Cont'd.)

Nominal Size (in)	Threads/Inch	Part Number	Description	Dimensions across flat	Thickness
–	–	1P-3000	Complete Hexagon Rethreading Fractional Die Set	–	–
Hexagon Rethreading Fractional Die Set Consists of:					
1	14 NS	3P-2213	Taps and Dies	13/16 in	1
1	8 NC	1P-2997	Taps and Dies	13/16 in	1 in
1/2	13 NC	1P-2987	Taps and Dies	1/16 in	1/2 in
1/2	20 NF	1P-2988	Taps and Dies	1/16 in	1/2 in
1/4	20 NC	1P-2979	Taps and Dies	19/32 in	1/4 in
1/4	28 NF	1P-2980	Taps and Dies	19/32 in	1/4 in
3/4	10 NC	1P-2993	Taps and Dies	7/16 in	3/4 in
3/4	16 NF	1P-2994	Taps and Dies	7/16 in	3/4 in
3/8	16 NC	1P-2983	Taps and Dies	25/32 in	3/8 in
3/8	24 NF	1P-2984	Taps and Dies	25/32 in	3/8 in
5/16	18 NC	1P-2981	Taps and Dies	11/16 in	5/16 in
5/16	24 NF	1P-2982	Taps and Dies	11/16 in	5/16 in
5/8	11 NC	1P-2991	Taps and Dies	1/4 in	5/8 in
5/8	18 NF	1P-2992	Taps and Dies	1/4 in	5/8 in
7/16	14 NC	1P-2985	Taps and Dies	7/8 in	7/16 in
7/16	20 NF	1P-2986	Taps and Dies	7/8 in	7/16 in
7/8	14 NF	1P-2996	Taps and Dies	5/8 in	7/8 in
7/8	9 NC	1P-2995	Taps and Dies	5/8 in	7/8 in
9/16	12 NC	1P-2989	Taps and Dies	1/16 in	1/2 in
9/16	18 NF	1P-2990	Taps and Dies	1/16 in	1/2 in
Optional Rethreading Fractional Dies					
1	12 NF	1P-2998	Taps and Dies	13/16 in	1 in
1 1/2	12 NF	4C-5497	Taps and Dies	9/16 in	1 in
1 1/4	12 NF	4C-5495	Taps and Dies	3/16 in	1 in
1 1/8	12 NF	4C-5494	Taps and Dies	1 in	1 in
1 3/4	5 NF	5P-4238	Taps and Dies	1 in	1 1/4 in
1 3/8	12 NF	4C-5496	Taps and Dies	3/8 in	1 in
M10 x 1.25	–	8T-3069	Taps and Dies	7/8 in	7/16 in
M11 x 1.50	–	8T-3071	Taps and Dies	7/8 in	7/16 in
M12 x 1.25	–	8T-3072	Taps and Dies	1/16 in	1/2 in
M12 x 1.50	–	8T-3073	Taps and Dies	1/16 in	1/2 in
M13 x 1.50	–	8T-3075	Taps and Dies	1/16 in	1/2 in
M14 x 1.50	–	9F-9398	Taps and Dies	–	–
M15 x 1.50	–	8T-3076	Taps and Dies	1/4 in	5/8 in
M16 x 1.50	–	8T-3077	Taps and Dies	1/4 in	5/8 in
M4 x 0.70	–	8T-3062	Taps and Dies	19/32 in	1/4 in
M5 x 0.80	–	8T-3063	Taps and Dies	19/32 in	1/4 in
M7 x 1.00	–	8T-3065	Taps and Dies	11/16 in	5/16 in
M9 x 1.00	–	8T-3067	Taps and Dies	25/32 in	3/8 in
M9 x 1.25	–	8T-3068	Taps and Dies	25/32 in	3/8 in

Metal Cutting — Taps and Dies

Hexagon Rethreading Metric Die Set - 4C-4963

Warranty: Manufacturer, 120 Day

- Includes plastic index

Nominal Size (in)	Part Number	Description	Dimensions across flat	Thickness
–	4C-4963	Complete Hexagon Rethreading Metric Die Set	–	–
Hexagon Rethreading Metric Die Set Consists of:				
M10 x 1.50	8T-3070	Taps and Dies	7/8 in	7/16 in
M12 x 1.75	8T-3074	Taps and Dies	1 1/16 in	1/2 in
M14 x 2.00	4C-4961	Taps and Dies	1 1/16 in	1/2 in
M16 x 1.00	4C-4182 ⁽⁵⁾	Taps and Dies ⁽⁶⁾	1 1/4 in	7/16 in
M16 x 2.00	8T-3078	Taps and Dies	1 1/4 in	5/8 in
M20 x 2.50	4C-4962	Taps and Dies	1 5/8 in	7/8 in
M6 x 1.00	8T-3064	Taps and Dies	19/32 in	1/4 in
M8 x 1.25	8T-3066	Taps and Dies	11/16 in	5/16 in
Optional				
M16 x 1.00	4C-4181	Taps and Dies	1 1/4 in	5/8 in
M30 x 3.50	4C-6722	Rethreading Die	2 3/16 in	1 in

Hexagon Rethreading Pipe Dies - Individual

Warranty: Manufacturer, 120 Day

Nominal Pipe Size (in)	Threads/Inch	Part Number	Dimensions across flat	Across Thickness
1/2	14	4C-4960	1 5/8 in	3/4 in
1/4	18	4C-4958	1 1/4 in	5/8 in
1/8	27	4C-4957	1 7/16 in	3/8 in
3/8	18	4C-4959	1 5/8 in	5/8 in

Special Rethreading Dies



Warranty: Manufacturer, 120 Day

- Used for cleaning up damaged external threads
- Not readily obtainable on the market because the threads are not common standards

Part Number	Size
1P-2998	1 in-12 UNF
5P-4238	1 3/4 in-5 NC
6V-7052	1 5/16 in-12 NF
9F-9398	14 mm x 1.5 mm Pitch

5 Not available for individual sale

6 Warranty: Caterpillar, Six Months

Universal Outside Thread Chasers



Warranty: Cat Standard Warranty, 6 Months

- Precision dies restore threads to their original condition to make reassembly of matching parts easier
- Eliminates the need for expensive thread-cutting equipment
- Tighten the tool slightly on the good threads, then back off over the damaged thread area to restore the threads
- 1- 1/4 in to 5 in outer diameter

Part Number	Per Capacity	Description	Weight
1U-7521	4, 5, 6, 7, 7 1/2, 8, 9, 10, 11, 11 1/2, 12, 14, 16, 18, 20, 24	Standard Thread Chaser (complete with 6 dies)	1.4 kg (3 lb)
1U-7610	1 mm-1.25 mm-1.5 mm-1.75 mm; 2 mm-2.5 mm; 3.0 mm-3.5 mm; 4 mm	Dies only (3 dies)	0.4 kg (0.99 lb)

Thread File Group - 154-9315



Warranty: Cat Standard Warranty, 6 Months

Model, 311, 312, 312B, 315B, and 318B Excavators (Grenoble Version)

Reference

REN1113 Service Manual, 312B Excavators Machine Systems Disassembly and Assembly

- Used to renew damaged external threads on any diameter shaft (right or left handed)
- Cross-cut and thread proportional to thread pitch (helps eliminate file skipping or jumping out of fine pitches)
- Each file has eight separate pitches
- Makes thread repairs without using a thread die
- Red plastic handle protects hands
- Each file is individually packaged in a plastic tube
- Carrying pouch keeps files together
- Files can also be ordered separately

Part Number	Description	Pitch
154-9315	Complete Thread File Group	9, 10, 12, 16, 20, 27, 28, and 32 tpi
Thread File Group Consists of:		
154-9316	Metric Thread File	0.75, 1.00, 1.25, 1.50, 1.75, 2.00, and 3.00
154-9317	Inch Thread File	11, 12, 13, 14, 16, 18, 20, and 24 tpi
154-9318	Inch Thread File	9, 10, 12, 16, 20, 27, 28, and 32 tpi
154-9319	Pipe Thread File	8, 10, 11 1/2, 14, 16, 18, 24, and 27 tpi
160-1749	Roll-up Pouch	—

Metal Cutting — Taps and Dies

Taper Pipe Tap Set - 2P-5530



Warranty: Manufacturer, 120 Day

NOTE: These are ground thread taps meeting requirements of right hand American Standard Pipe Form (NPT) and American Standard Dryseal Pipe Form (NPTF). Dry-seal taps are used to tap fittings which will give a pressure tight joint without use of a "sealer".

- Contains 4 taper pipe taps 1/8 inch, 1/4 inch, 3/8 inch and 1/2 inch NPTF, shown here
- Includes plastic index

Nominal Pipe Size (in)	Threads/Inch	Number of Flutes	Part Number	Thread Length	Overall Length
2P-5530 Set Contains					
1/2	14	4	2P-5534	1 3/8	79.5 mm (3.13 in)
1/4	18	4	2P-5532	1 1/16	62 mm (2.44 in)
1/8	27	4	2P-5531	3/4	54.1 mm (2.13 in)
3/8	18	4	2P-5533	1 1/16	65 mm (2.56 in)
Taper Pipe Taps — Individual					
1/16	27	4	4C-9747	—	54.1 mm (2.13 in)
3/4	14	5	214-3635	1 3/8	82.6 mm (3.25 in)

Metric Size Taps - Individual

Warranty: Manufacturer, 120 Day

Nominal Size	Pitch Diameter Limits	Number of Flutes	Part Number	Nominal Size	Pitch Diameter Limits	Number of Flutes	Part Number
Plugs							
M10 x 1.25	—	4	8T-3086	M36 x 4	—	4	423-8713
M10 x 1.50	D6	4	8T-3087	M36 x 4	D9	4	4C-4970
M11 x 1.50	—	4	8T-3088	M4 x 0.7	—	4	8T-3079
M12 x 1.25	—	4	8T-3089	M42 x 4.5	D5	4 or 6	9U-6901
M12 x 1.50	—	4	8T-3090	M48 x 5	D5	6	9U-6503
M12 x 1.75	D6	4	8T-3091	M5 x 0.8	D4	4	8T-3080
M13 x 1.50	—	4	8T-3092	M6 x 1	D5	4	8T-3081
M14 x 1.50	—	4	8T-3093	M64 x 6.0	D5	4 or 6	9U-6902
M14 x 2	D7	4	4C-4965	M7 x 1.0	—	4	8T-3082
M15 x 1.50	—	4	8T-3094	M8 x 1.25	D5	4	8T-3083
M16 x 1.50	—	4	8T-3095	M9 x 1.0	—	4	8T-3084
M16 x 2	D7	4	8T-3096	M9 x 1.25	—	4	8T-3085
M18 X 1.5	D6	4	9U-7283	Bottoming			
M18 x 2.5	D7	4	4C-4966	M10 x 1	D6	4	4C-5894
M20 x 1.5	D7	4	9U-5794	M14 x 1	D7	4	4C-6924
M20 x 2.5	D7	4	4C-4967	M16 x 2	D6	4	4C-9645
M22 x 1.5	D6	4	156-8166	M27 x 3	D6	4	386-3218
M24 x 3.0	D8	4	4C-4968	M39 x 4	D6	6	386-3219
M30 x 3.5	D9	4	4C-4969	M42 x 3	D6	6	386-3220
				M64 x 4	D6	6	386-3221

Tap Wrenches

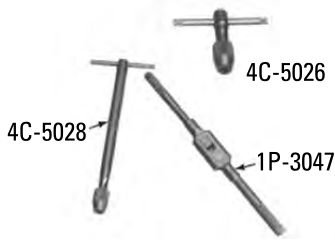

Warranty: Manufacturer, 120 Day

- Designed for use in hand tapping but can also be used with reamers, drills, screw extractor or other hand cutting tools
- Jaws are made of carefully hardened and tempered steel
- Ruggedly built yet nicely furnished
- Caterpillar offers two types of tap wrenches:
 - - T-Handle
 - - Straight

Part Number	Description	Usage
4C-5026	Slip Handle	The T-Handle may be "slipped" from side to side to permit a complete turn in close quarters.
4C-5028	Long Shank	The long shank permits tapping in hard to reach places encountered in machine and automobile repair work.
4C-5029	Ratchet	The combination of ratchet and slip handle make this an all around wrench capable of handling most hand tapping jobs.
1P-3047	Solid Handle	These wrenches have solid handles, one of which is forged integral with the center. Adjustment is made by turning the movable handle.

Description	Part Number	Length	Used with Fractional Taps	Machine Screw Taps	Metric Taps	Pipe Taps
T-Handle Tap Wrenches						
Long Shank	4C-5028	222.2 mm (8.75 in)	1/16 in - 1/4 in	0-14	1 - 6 mm	—
Ratchet	4C-5029	95.2 mm (3.75 in)	1/16 in - 1/4 in	0-14	1 - 6 mm	—
Slip Handle	4C-5026	69.8 mm (2.75 in)	1/16 in - 1/4 in	0-14	1 - 6 mm	—
Straight Tap Wrenches						
Solid Handle Tap Wrench	1P-3047	279.4 mm (11 in)	5/32 in - 1/2 in	7-14	4 - 13 mm	1/8
Solid Handle Tap Wrench	1P-3048	482.6 mm (19 in)	1/4 in - 1 1/8 in	—	6 - 24 mm	1/8 - 3/4

Metal Cutting — Extractors

Individual Extractors

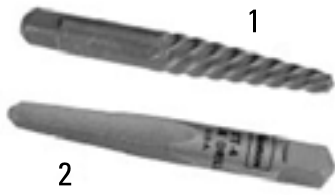

Warranty: Manufacturer, 120 Day

- Useful in maintenance departments, machine shops, garages, workshops, etc., to remove broken screws, bolts or other threaded parts
- First, drill a hole into the broken part. Insert the extractor. By twisting to the left, the extractor will grip into the wall of the hole and the broken part can be backed out without damaging threads.

Extractor Size	Part Number	Used with Drill Size	Used to Remove Screws and Bolts	Used to Remove Pipe
Left Hand Spiral Tapered Flutes (Item 1)				
1	4C-3364	5/64	2.5 mm - 6.0 mm (3/16 in - 1/4 in)	—
2	4C-3365	7/64	6.0 mm - 8.0 mm (1/4 in - 5/16 in)	—
3	4C-3366	5/32	8.0 mm - 12.0 mm (5/1 in - 7/16 in)	—
4	4C-3367	1/4	12.0 mm - 14.0 mm (7/16 in - 9/16 in)	—
5	4C-3368	17/64	14.0 mm - 20.0 mm (9/16 in - 3/4 in)	1/8 in
6	4C-3369	13/32	20.0 mm - 24.0 mm (3/4 in - 1 in)	—
7	4C-3370	17/32	24.0 mm - 35.0 mm (1 in - 1 3/8 in)	—
8	4C-3372	1 1/16	44.0 mm - 54.0 mm (1 3/4 in - 2 1/8 in)	1 in
Straight Tapered Flutes (Item 2)				
1	4C-3374	9/64 in	2.5 mm - 8.0 mm (1/4 in - 5/16 in)	—
2	4C-3375	3/16 in	9.0 mm - 10.0 mm (3/8 in)	—
3	4C-3376	15/64 in	12.0 mm (7/16 in)	1/8 in
4	4C-3377	5/16 in	13.0 mm - 14.0 mm (1/2 in - 9/16 in)	1/4 in
5	4C-3378	3/8 in	15.0 mm - 16 mm (5/8 in)	3/8 in
6	4C-3380	9/16 in	22.0 mm (7/8 in)	—

Extractor Sets

Warranty: Manufacturer, 120 Day



- For removing broken screws and bolts (eliminates re-drilling and retapping for a larger screw)

Part Number	Used to Remove
4C-3383 Extractor Set, Straight Tapered, Consists of:	
4C-3374	3/16 in to 5/16 in
4C-3375	3/8 in
4C-3376	7/16 in and 1/8 in Pipe
4C-3377	1/2 in to 9/16 in and 1/4 in Pipe
4C-3378	5/8 in and 3/8 in Pipe
4C-3379	3/4 in and 1/2 in Pipe
4C-3382 Extractor Set, Left Hand Spiral, Consists of:	
4C-3364	3/32 in to 5/32 in
4C-3365	5/32 in to 7/32 in
4C-3366	7/32 in to 9/32 in
4C-3367	9/32 in to 3/8 in and 1/8 in Pipe
4C-3368	3/8 in to 5/8 in and 1/4 in Pipe
4C-3369	5/8 in to 7/8 in and 3/8 in Pipe
4C-3370	7/8 in to 1 1/8 in and 1/2 in Pipe
4C-3371	1 1/8 in to 1 3/8 in and 3/4 in Pipe
4C-3372	1 3/8 in to 2 in and 1 in Pipe
4C-3381 Extractor Set, Left Hand Spiral, Consists of:	
4C-3364	3/32 in to 5/32 in

Part Number	Used to Remove
4C-3365	5/32 in to 7/32 in
4C-3366	7/32 in to 9/32 in
4C-3367	9/32 in to 3/8 in and 1/8 in Pipe
4C-3368	3/8 in to 5/8 in and 1/4 in Pipe
4C-3369	5/8 in to 7/8 in and 3/8 in Pipe
4C-5530 Extractor Set, Straight Tapered, Consists of:	
4C-3374	3/16 in to 5/16 in
4C-3375	3/8 in
4C-3376	7/16 in and 1/8 in Pipe
4C-3377	1/2 in to 9/16 in and 1/4 in Pipe
4C-3378	5/8 in and 3/8 in Pipe
4C-3384 Extractor Set, Left Hand Spiral, in vinyl pouch, Consists of:	
4C-3364	3/32 in to 5/32 in
4C-3365	5/32 in to 7/32 in
4C-3366	7/32 in to 9/32 in
4C-3367	9/32 in to 3/8 in and 1/8 in Pipe
4C-3368	3/8 in to 5/8 in and 1/4 in Pipe

Left Hand Spiral Screw Extractor - 1B-9925

Warranty: Cat Standard Warranty, 6 Months

- Originally used for the removal of burner tubes in the D70, D65 Tractors and D9900 Power Units
- Used to remove broken screws and bolts
- Eliminates re-drilling and retapping for larger screw



Part Number	Turn	Spiral Length	Taper/Foot	Square Drive	Overall Length
1B-9925	1/2 in	1 3/4 in	1 3/8 in	5/8 in	10 1/2 in

Metal Cutting — Extractors

Extractor Set, 10 piece - 282-2108



SMCS Code: 0671

Warranty: Manufacturer, 120 Day

- Standard extractors for righthand pipe and studs
- Four-point grip assures strong bite
- Works with shallow grip which lessens expansion and jamming
- Pulls rather than reams
- Releases from bite instantly after job completed
- Designed for strength, durability, and easy handling
- Rust resistant, black oxide finish
- Complete set of only 10 extractors fits every size and class of pipe from 1/8 to 2 inch
- Also fits every stud and screw from 3/8 to 3 1/2 inch
- Comes in sturdy plastic case
- Can also be ordered individually

Part Number	Description	Broken Pipe Length (in)	Broken Stud/Screw Length (in)
282-2108	Complete Extractor Set	—	—
Extractor Set Consists of:			
282-2111	Extractor	3/8	5/8 or 3/4
282-2112	Extractor	1/2	—
282-2113	Extractor	—	7/8 or 1
282-2115	Extractor	3/4	1 1/8 or 1 1/4
282-2116	Extractor	1	1 1/2 or 1 3/4

Stud Remover Set - 2P-5535



Warranty: Cat Standard Warranty, 6 Months

- Extractors are not threaded and thus will accommodate studs with either coarse or fine threads
- Saves time when removing a number of studs and eliminates thread damage

Reference

GMG02078 Special Instruction

Item	Part Number	Description
—	2P-5535	Complete Stud Remover Set
Stud Remover Set Consists of:		
1	—	Extractor, 3/4 in
2	—	Extractor, 7/8 in
3	2P-5529	Extractor, 1 in
4	2P-5497	Body
5	2P-5538	Bolt
6	2P-5537	Washer

Stud Remover and Resetter Tool Set, 1/4 through 5/8 in - 8S-1378

Warranty: Lifetime



Part Number	Description	Size
8S-1378	Complete Stud Remover and Resetter Tool Set, 1/4 through 5/8 in	—
Stud Remover and Resetter Tool Set, 1/4 through 5/8 in, Consists of:		
8S-1346	Collet	5/8 in - 11
8S-1364	Box	—
8S-1365	Collet	1/4 in - 20
8S-1366	Collet	1/4 in - 28
8S-1368	Collet	5/16 in - 24
8S-1369	Collet	3/8 in - 16
8S-1370	Collet	3/8 in - 24
8S-1371	Collet	7/16 in - 14
8S-1372	Collet	7/16 in - 20
8S-1373	Collet	1/2 in - 13
8S-1375	Collet	9/16 in - 12
8S-1376	Collet	9/16 in - 18
8S-1377	Collet	5/8 in - 18
Not Shown		
8S-1347	Housing	—
8S-1374	Collet	1/2 in - 20

Metal Cutting — Extractors

Metric Stud Installers

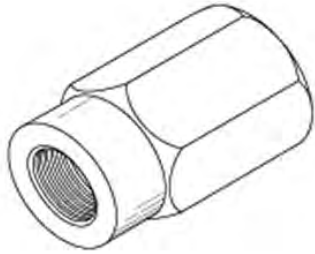

Essential Tool
Warranty: Lifetime

- Used to quickly and easily install metric studs (not for stud removal)
- Can be used with standard wrench or impact wrench
- Reduces possible damage to threads
- Designed to easily release from stud after installation
- Ensures reliable bolted joint (reduces chance of stud backout)

Part Number	Size
204-7932	M16 x 2.0
204-7933	M20 x 2.5
204-7934	M24 x 3.0
204-7935	M30 x 3.5
204-7936	M36 x 3.0

Metal Cutting — Cutting Torch Equipment

Mini Cutting Torch - 8T-7792

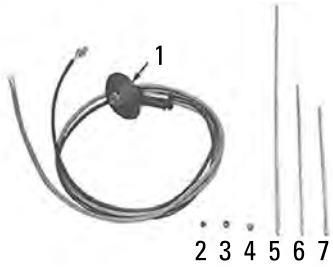

Warranty: Manufacturer, 30 Day

- Will cut cast iron, stainless steel, high alumina refractory, and slag
- Can be used indoors, because the noise and smoke levels are very low
- Faster and less expensive than carbon arc and requires oxygen only
- Durable, comfortable, and less fatiguing to use
- Large squeeze trigger-type handle control delivers oxygen precisely
- Excellent tool for gouging hard facing. Unlike carbon arc, the rods contain no carbon, thus reducing the grinding requirement

Reference

Form SEHS8923

Details
Rod Sizes Used by Mini Cutting Torch
General purpose rods for removing small bolts and pins by piercing
4.76 mm x 55.24 cm (3/16 in x 21 3/4 in)
6.35 mm x 55.24 cm (1/4 in x 21 3/4 in)
Rods for piercing track pins, washing away welds, and gouging hard facing
9.52 mm x 46.67 cm (3/8 in x 18 3/8 in)
Cut off and gouging rod for piercing longer pins and rough cutting
9.52 mm x 91.44 cm (3/8 in x 36 in)

Item	Part Number	Description
1	8T-7792	Complete Mini Cutting Torch
Mini Cutting Torch Consists of:		
2	8T-9110	Washer
3	8T-7795	Collet, 4.76 mm (3/8 in)
4	8T-7794	Collet, 6.35 mm (1/4 in)
Not shown	8T-7793	Striker Plate
Not shown	8T-9202	Collet, 4.76 mm (3/16 in)
Not shown	8T-9287	Washer
Purchase separately		
5	8T-7697	Rod, 9.52 mm x 914.4 mm (3/8 in x 36 in)
6	8T-7696	Rod, 6.35 mm x 55.24 cm (1/4 in x 21 3/4 in)
7	8T-7698	Rod, 4.76 mm x 45.72 cm (3/8 in x 18 in)
Not shown	8T-7699	Igniter
Not shown	8T-9201	Rod, 4.76 mm x 55.24 cm (3/16 in x 21 3/4 in)
Not shown	9U-5614	Shield
Not shown	9U-5615	Collet Nut-Brass

Metal Cutting — Miscellaneous

Surface Texture Replica (Comparison) - 9A-1593



Warranty: Cat Standard Warranty, 6 Months

- Used as a reference tool for metal surface reconditioning during reuse and salvage of major components
- Provides user with a physical representation of surface finish specifications that are called out in Reuse and Salvage Guidelines
- Provides 12 examples of F, H, K, and N surface textures for cast iron and steel

Reference

SEBF8271, Guideline for Reusable Parts

Part Number	Description
9A-1593	Metal Surface Texture Replica

Metal Etching Pen



Warranty: Cat Standard Warranty, 6 Months

- Leaves distinctive, smudge-proof, black markings
- Indispensable anyplace where metals, hardened or thin-walled, have to be marked or identified
- Strong effect on heavy metals, stainless steel, iron, copper, brass, nickel, tin, lead
- No electrical flux necessary; special acid solution flows like ink in a felt-tip pen and a permanent etch is produced on the metal
- Ideal for toolroom use and marking in the machine shop
- Apply on clean surface; after application wipe dry with oily cloth.

Part Number	Description
9U-7377	Metal Etching Pen

Full-Torque® Thread Repair Kits



- Unique threaded insert design repairs damaged threaded holes in cast and ductile iron, steel, and aluminum
- Spiralhook™ threads engage tapped hole and draw surrounding metal into threads, as bolt or stud is torqued, resulting in a stronger repair
- Thread Repair Solid Plug inserts allow off-center and custom-size thread repairs
- Viable alternative to welding cast and ductile iron, steel, and aluminum
- In many cases parts can be repaired without disassembly
- Six kits with individual written installation instructions for a wide range of repair solutions

Part Number	Description	Qty.
263-7140 - Thread Repair Kit: 1-8 Thread Insert Kit for ductile iron in Off-Highway Truck and Wheel Loader wheels; can also be used on steel fabricated and cast wheels		
263-7160	Drill Bit, 1 9/64 inch	
263-7161	Rough Tap	1
263-7162	Finish Tap	1
263-7170	Installation Tool	1
263-7173	Thread Insert, M30	5
263-7145 - M20 Thread Insert Kit for repair of 3116 block head bolt holes		
263-7174	Thread Insert, M20	5
263-7180	Drill Bit, 57/64 inch	1
263-7181	Rough Tap	1
263-7182	Finish Tap	1
263-7183	Installation Tool	1
263-7141 - M24 Thread insert Kit for ductile iron in Off-Highway Truck and Wheel Loader wheels; can also be used on steel fabricated and cast wheels		
263-7160	Drill Bit, 1 9/64 inch	1
263-7161	Rough Tap	1
263-7162	Finish Tap	1
263-7167	Installation Tool	1
263-7168	Thread Insert, M24	5
263-7142 - M30 Thread Insert Kit for ductile iron housing on 797 Off-Highway Truck wheels		
263-7157	Rough Tap	1

Part Number	Description	Qty.
263-7158	Finish Tap	1
263-7165	Installation Tool	1
263-7173	Thread Insert, M30	5
263-7178	Drill Bit, 1 25/64 inch	1
263-7179	Drill Fixture	1
263-7144 - M36 Thread Insert Kit for ductile iron housing on 797 Off-Highway Truck wheels; also used for repairing 797 front axle steering bracket mounting holes		
263-7155	Rough Tap	1
263-7156	Finish Tap	1
263-7163	Installation Tool	1
263-7164	Thread Insert, M36	5
263-7172	Drill Bit, 1 41/64 inch	1
263-7179	Drill Fixture	1
263-7146 - Thread Repair Solid Plug Insert Kit for drilling and tapping off-center and custom-size threaded holes; used for repairing 797 differential retaining bolt holes in thrust washer halves ⁽¹⁾		
263-7175	Solid Plug Insert	5
263-7177	Spotfacer	1
263-7255	Rough Tap	1
263-7256	Finish Tap	1
263-7258	Tapping Fluid	1
263-7259	Thread Sealant	1
263-7260	Drill Bit, 21/32 inch	1

1 Maximum I.D. thread size of original threaded hole is 1/2 inch

Metal Repair

263-7147 Lock-N-Stitch® Crack Repair Kit



- Unique threaded stitching pins and locks repair cracks in cast and ductile iron, steel, or aluminum castings
- L-Series Stitching Pins use an interference fit to seal pressure tight and can be installed at steep angles
- C-Series Stitching Pins feature Spiralhook™ threads to produce drawing pressure that pulls sides of the crack together for strength
- Locks installed across a crack; drill jigs create precise hole patterns across cracks in castings; locks driven into hole patterns creating additional strength
- Cold process—viable alternative to welding
- In many cases parts can be repaired without disassembly
- Extensive kit features specialized tools, complete instructions including six DVDs covering all aspects of crack repair, and storage case
- Provides a wide range of repair solutions

Part Number	Description	Qty.
263-7147	Crack Repair Kit	–
Tools		
263-7184	Magcheck™ Kit	1
263-7190	Pneumatic Tapping Tool	1
263-7249	Trim-Kut® 3 inch Discs (includes 1/4 inch mandrel)	10
263-7253	Large Collet for 263-7190	1
263-7254	Quick Change Tap Adapter	1
"L" Series Stitching Pins, 6.3 mm (.248 in) Thread Diameter		
263-7193	Stitch Pin, 6.3 mm (.250 in) length	100
263-7194	Stitch Pin, 9.5 mm (.375 in) length	100
263-7195	Stitch Pin, 15.9 mm (.625 in) length	100
263-7196	Stitch Pin, 25.4 mm (1.00 in) length	100
263-7197	Drill Bit, wire size 7	2
263-7198	Starting Tap	1
263-7199	Bottom Tap	1
263-7200	Piloted Tap	1
263-7201	Drilling Jig	1
"L" Series Stitching Pins, 8.3 mm (.326 in) Thread Diameter		
263-7202	Stitch Pin, 6.3 mm (.250 in) length	100
263-7203	Stitch Pin, 12.7 mm (.500 in) length	100
263-7204	Stitch Pin, 25.4 mm (1.00 in) length	100
263-7205	Starting Tap	1
263-7206	Bottom Tap	1
263-7207	Piloted Tap	1
263-7208	Drill Bit, letter size L	2
263-7250	Drilling Jig	1
"C" Series Stitching Pins, 6.0 mm (.233 in) Thread Diameter		
263-7197	Drill Bit, wire size 7	2
263-7201	Drilling Jig	1
263-7209	Stitch Pin, 6.3 mm (.250 in) length	100

Part Number	Description	Qty.
263-7210	Stitch Pin, 9.5 mm (.375 in) length	100
263-7211	Stitch Pin, 12.7 mm (.500 in) length	100
263-7212	Stitch Pin, 19 mm (.750 in) length	100
263-7213	Stitch Pin, 28.6mm (1.125 in) length	100
263-7215	Finishing Tap, fine	1
263-7216	Bottom Tap, fine	1
263-7217	Spotfacer	1
263-7218	Drill Stop	1
"C" Series Stitching Pins, 9.5 mm (.375 in) Thread Diameter		
263-7219	Stitch Pin, 15.9 mm (.625 in) length	25
263-7220	Stitch Pin, 22.2 mm (.875 in) length	25
263-7221	Stitch Pin, 34.9 mm (1.375 in) length	25
263-7222	Stitch Pin, 50.8 mm (2.00 in) length	25
263-7223	Rough Tap	1
263-7224	Bottom Tap	1
263-7225	Bottom Tap	1
263-7226	Drill Bit, letter size O	2
263-7227	Spotfacer	1
263-7228	Drill Stop	1
263-7251	Drilling Jig	1
Lock, 20 mm (.793 in) Long		
263-7230	Lock, 3.2 mm (.125 in) thick	10
263-7232	Drill Bit, wire size 15	3
263-7233	Drill Stop	1
263-7234	Drilling Jig	1
Lock, 36 mm (1.409 in) Long		
263-7235	Bottom Lock, 2 mm (.080 in) thick	10
263-7236	Surface Lock, 4 mm (.160 in) thick	10
263-7238	Drill Bit Set, 1/8 and 3/16 inch	3 each
263-7239	Drilling Jig	1
263-7240	Drill Stop, 1/8 inch	1

263-7147 Lock-N-Stitch Crack Repair Kit (Cont'd.)

Part Number	Description	Qty.	Part Number	Description	Qty.
263-7241	Drill Stop, 3/16 inch	1	263-7243	Surface Lock, 9.5 mm (.375 in) thick	5
Lock, 48 mm (1.877 in) Long			263-7244	Drill Bit Set, 1/8 and 1/4 inch	3 each
263-7240	Drill Stop, 1/8 inch	1	263-7245	Drilling Jig	1
263-7242	Bottom Lock, 5 mm (.190 in) thick	10	263-7246	Drill Stop, 1/4 inch	1

Heli-Coil® Inserts



- Effective and universally accepted method of thread repair
- Quickly and permanently restore stripped, worn or damaged threads to their original size and condition
- Inserts work in any material: aluminum, magnesium, cast iron, bronze, etc.
- Increasing use of lightweight (and soft) materials means more thread damage—there is a Heli-Coil repair for virtually every application
- Stainless steel
- Provide leak tight joints (ex. spark plugs)

Stainless Steel Heli-Coil inserts eliminate:

- Thread wear
- Corrosion
- Galling
- Rust

and provide...

- Stronger assemblies
- High quality and reliability
- Fastening integrity superior to the original

Metal Repair

Master Thread Repair Sets



Warranty: Manufacturer, One Year

Master Thread Repair Sets

- Both sets contain repairs for the most commonly used thread sizes
- Two Master Sets for inch sizes are available: one for Inch Coarse (4C-8364) and one for Inch Fine (4C-8365)
- The coarse set contains six sizes: 1/4 inch, 5/16 inch, 3/8 inch, 7/16 inch, 1/2 inch and 5/8 inch
- The fine set has six sizes: #10, 1/4 inch, 5/16 inch, 3/8 inch, 7/16 inch and 1/2 inch
- Each set has a drill, tap, installation tool, a quantity of inserts for each size, and complete instructions

Optional Inch Coarse Thread Repair Kits

- Kits include insert, tap, installation tool, tang break-off tool, and drill
- Tang break-off tool included in 1/4 -20 through 1/2 -13 only
- Insert package contains inserts only

Optional Inch Fine Thread Repair Kits

- Kits include insert, tap, installation tool, tang break-off tool, and drill
- Tang break-off tool included in 10-32 through 1/2 -20 only
- Insert package contains inserts only

NOTE:

Installation tools, prewinder and mandrel included in Fine Series only.

Thread Size x Length	Insert Package Part Number	Qty.	Tap Part Number	Drill Size	Installation Tool Part Number	Inserts/Kit	Insert Package Part Number	Drill Part Number
4C-8364 - Inch Coarse Master Thread Repair Set								
1/2 in-13 x .750 in	4C-8423	6	4C-9685	17/32 in	8T-2706	–	–	–
1/4 in-20 x .375 in	4C-8419	12	–	17/64 in	8T-2692	–	–	–
3/8 in-16 x .562 in	4C-8421	12	4C-9683	25/64 in	8T-2698	–	–	–
5/16 in-18 x .469 in	4C-8420	12	4C-9682	21/64 in	8T-2695	–	–	–
5/8 in-11 x .938 in	4C-8425	6	4C-9686	21/32 in	6V-9083	–	–	–
7/16 in-14 x .656 in	4C-8422	6	–	29/64 in	–	–	–	–
4C-8365 - Inch Fine Master Thread Repair Set								
1/2 in-20 x .750 in	4C-8438	6	4C-9692	33/64 in	8T-2742	–	–	–
1/4 in-28 x .375 in	4C-8434	12	–	17/64 in	8T-2730	–	–	–
10-32 x .285 in	4C-8433	12	4C-9687	13/64 in	8T-2727	–	–	–
3/8 in-24 x .562 in	4C-8436	12	–	25/64 in	–	–	–	–
5/16 in-24 x .469 in	4C-8435	12	4C-9689	21/64 in	–	–	–	–
7/16 in-20 x .656 in	4C-8437	6	4C-9691	29/64 in	–	–	–	–
Optional Inch Coarse Thread Repair Kits								
1 1/2 -6 x 2.250	–	1	4C-9720	1 17/32	–	4	4C-8432	–
1 1/4 -7 x 1.875	4C-8379	1	4C-9721	1 9/32	8T-2721	4	4C-8430	–
1 1/8 -7 x 1.688	4C-8378	1	4C-9722	1 5/32	8T-2718	5	4C-8429	1U-5702
1-8 x 1.500	4C-8377	1	–	1 1/32	8T-2715	6	4C-8428	1U-5698

Master Thread Repair Sets (Cont'd.)

Thread Size x Length	Insert Package Part Number	Qty.	Tap Part Number	Drill Size	Installation Tool Part Number	Inserts/Kit	Insert Package Part Number	Drill Part Number
1/2 -13 x .750 ⁽²⁾	4C-8372	6	4C-9685	17/32	8T-2706	12	4C-8423	1U-5682
1/4 -20 x .375 ⁽²⁾	4C-8368	12	4C-9681	17/64	8T-2692	24	4C-8419	1U-5634
3/4 -10 x 1.125	4C-8375	4	4C-9725	25/32	–	4	4C-8426	1U-5690
3/8 -16 x .562 ⁽²⁾	4C-8370	12	4C-9683	25/64	8T-2698	12	4C-8421	1U-5642
5/16 -18 x .469 ⁽²⁾	4C-8369	12	4C-9682	21/64	8T-2695	24	4C-8420	1U-5638
5/8 -11 x .938 ⁽²⁾	4C-8374	6	4C-9686	21/32	6V-9083	6	4C-8425	1U-5686
7/16 -14 x .656 ⁽²⁾	4C-8371	6	4C-9684	29/64	–	12	4C-8422	1U-5646
7/8 -9 x 1.312	4C-8376	1	4C-9724	29/32	8T-2712	6	4C-8427	1U-5694
9/16 -12 x .844	4C-8373	6	4C-9700	19/32	–	6	4C-8424	1U-5684
Optional Fine Thread Repair Kits								
1 1/2 -12 x 2.250	4C-8397	1	–	1 17/32	8T-2760	4	4C-8447	–
1 1/4 -12 x 1.875	4C-8395	1	4C-9707	1 9/32	–	4	4C-8445	–
1 1/8 -12 x 1.688	4C-8394	1	4C-9706	1 5/32	–	5	4C-8444	1U-5702
1 3/8 -12 x 2.062	4C-8396	1	–	1 13/32	–	4	4C-8446	–
1-14 x 1.500	4C-8392	1	4C-9704	1 1/64	8T-2751	6	4C-8442	4C-8483
1/2 -20 x .750 ⁽²⁾	4C-8387	6	4C-9692	33/64	8T-2742	12	4C-8438	1U-7433
1/4 -28 x .375 ⁽²⁾	4C-8383	12	4C-9688	17/64	8T-2730	24	4C-8434	1U-5634
10-32 x .285 ⁽²⁾	–	12	4C-9687	13/64	8T-2727	24	4C-8433	1U-5630
3/4 -16 x 1.125	4C-8390	4	4C-9702	49/64	6V-9082	4	4C-8440	4C-8481
3/8 -24 x .562 ⁽²⁾	4C-8385	12	4C-9690	25/64	–	12	4C-8436	1U-5642
5/16 -24 x .469 ⁽²⁾	–	12	4C-9689	21/64	–	24	4C-8435	1U-5638
5/8 -18 x .938	4C-8389	6	–	41/64	–	6	4C-8439	4C-8480
7/16 -20 x .656 ⁽²⁾	4C-8386	6	4C-9691	29/64	–	12	4C-8437	1U-5646
7/8 -14 x 1.312	4C-8391	1	4C-9703	57/64	8T-2748	6	4C-8441	4C-8482
9/16 -18 x .844	4C-8388	6	4C-8469	37/64	4C-8486	6	4C-8497	1U-7434

Metric Master Thread Repair Set - 4C-8366

Warranty: Manufacturer, One Year

- Contains repairs for the most commonly used thread sizes: M5, M6, M8 and M10 x 1.50
- Set has a drill bit, tap, installation tool, a quantity of inserts for each size, and complete instructions

Thread Size x Length	Part Number	Description	Qty.	Tap Part Number	Drill Size	Installation Tool Part Number
–	4C-8366	Complete Metric Master Thread Repair Set	–	–	–	–
Metric Master Thread Repair Set Consists of:						
M10 x 1.515.0	4C-8452	Threaded Inserts	12	4C-9730	13/32	8T-2793
M5 x 0.8 7.5	4C-8448	Threaded Inserts	12	4C-9727	13/64	8T-3121
M6 x 19.0	4C-8449	Threaded Inserts	12	–	1/4	8T-2784
M8 x 1.25 12.0	4C-8451	Threaded Inserts	12	–	21/64	8T-2790

2 Also included in Master Thread Repair Set - 4C-8365

Metal Repair

Metric Master Thread Repair

Warranty: Manufacturer, One Year

- Contains repairs for the most commonly used thread sizes: M5, M6, M8 and M10 x 1.25
- Set has a drill bit, tap, installation tool, a quantity of inserts for each size, and complete instructions

Thread Size x Length	Part Number	Qty.	Tap Part Number	Drill Size	Installation Tool Part Number	Inserts/Kit	Insert Package Part Number	Drill Part Number
M10 x 1.25 15.0	4C-8410	12	4C-9715	13/32	8T-2763	12	4C-8460	1U-5643
M5 x 0.8 7.5	4C-8448	12	4C-9727	13/64	8T-3121	–	–	–
M6 x 19.0	4C-8449	12	–	1/4	8T-2784	–	–	–
M8 x 1.25 12.0	4C-8451	12	4C-8475	21/64	8T-2790	–	–	–

Metric Thread Repair Kits

Warranty: Manufacturer, One Year

Metric Coarse Thread Repair Kits

- Kits include insert, tap, installation tool, tang break-off tool, and drill
- Tang break-off tool included in M5 through M12 only

Metric Fine Thread Repair Kits

- Kits include insert, tap, installation tool, tang break-off tool, and drill
- Tang break-off tool included in M5 through M12 only

Thread Size x Length	Part Number	Qty.	Tap Part Number	Drill Size	Installation Tool Part Number	Inserts/Kit	Insert Package Part Number	Drill Part Number
Metric Coarse Thread Repair Kits								
M5 x 0.8 7.5 ⁽³⁾ ⁽⁴⁾	4C-8398	12	4C-9727	13/64	8T-3121	12	4C-8448	1U-5630
M6 x 1 9.0 ⁽³⁾ ⁽⁴⁾	4C-8399	12	–	1/4	8T-2784	12	–	1U-5633
M7 x 1 10.5	4C-8400	12	–	9/32	–	12	4C-8450	1U-5635
M8 x 1.25 12.0 ⁽³⁾ ⁽⁴⁾	4C-8401	12	4C-8475	21/64	8T-2790	12	4C-8451	1U-5638
M10 x 1.5 15.0 ⁽³⁾	4C-8402	12	4C-9730	13/32	8T-2793	12	4C-8452	1U-5643
M12 x 1.75 18.0	4C-8403	6	4C-9731	15/32	8T-2796	12	4C-8453	1U-5647
M14 x 2 21.0	4C-8404	6	4C-8472	37/64	4C-8489	12	4C-8454	1U-7434
M16 x 2 24.0	4C-8405	6	4C-9732	21/32	8T-2799	6	4C-8455	1U-5686
M18 x 2.5 27.0	4C-8406	6	4C-8473	47/64	–	6	4C-8456	–
M20 x 2.5 30.0	4C-8407	3	4C-8474	13/16	4C-8491	4	4C-8457	1U-5691
Metric Fine Thread Repair Kits								
M10 x 1 15.0	4C-8409	12	–	13/32	–	12	4C-8459	1U-5643
M10 x 1.25 15.0	4C-8410	12	4C-9715	13/32	8T-2763	12	4C-8460	1U-5643
M12 x 1.25 18.0	4C-8411	6	4C-9716	15/32	–	12	4C-8461	1U-5647
M12 x 1.5 18.0	4C-8412	6	4C-9717	15/32	–	12	4C-8462	1U-5647
M14 x 1.5 21.0	4C-8413	6	4C-9718	9/16	8T-2772	12	4C-8463	1U-5683
M16 x 1.5 24.0	4C-8414	6	–	21/32	8T-2775	6	4C-8464	1U-5686
M18 x 1.5 27.0	4C-8415	6	4C-8477	23/32	–	6	4C-8465	1U-5688

3 Also included in 4C-8366 Master Thread Repair Set

4 Also included in 4C-8367 Master Thread Repair Set

Spark Plug Thread Repair



4C-8416

Warranty: Manufacturer, One Year

Preferred method of repair specified by virtually all U.S. and foreign vehicle manufacturers.

- Kits are available in sizes M14, M18, and 7/8 inch
- Each kit contains a piloted tap (no drilling necessary), an installation tool, and a quantity of inserts
- The M14 Kit contains several insert lengths to accommodate all spark plug reaches

Thread Size	Reach	Part Number	Inserts/Kit	Tap Part Number	Installation Tool Part Number	Qty.
Kit Part Numbers						
14 - 1.25 mm	3/8 in	4C-8416	6	—	—	6
18 - 1.50 mm	1/2 in	4C-8417	24	4C-8478	—	6
7/8 in - 18	1/2 in - 5/8 in	4C-8418	10	4C-8479	4C-8496	5
Insert Package Part Numbers for 4C-8416						
14 - 1.25 mm ⁽⁵⁾	.472 in	9U-5125 ⁽⁶⁾	6	—	—	6
14 - 1.25 mm ⁽⁵⁾	1/2 in	9U-5123	6	8T-2801	8T-2802	6
14 - 1.25 mm ⁽⁵⁾	3/4 in	9U-5124	6	—	—	6
14 - 1.25 mm ⁽⁵⁾	3/8 in	9U-5121	6	—	—	6
14 - 1.25 mm ⁽⁵⁾	7/16 in	9U-5122	6	—	—	6
Insert Package Part Number for 4C-8417						
18 - 1.50 mm	1/2 in	4C-8466	24	—	—	6
Insert Package Part Number for 4C-8418						
7/8 - 18 in	1/2 in - 5/8 in	4C-8467 ⁽⁶⁾	10	—	—	5

Carded Inserts



4C-8421

Warranty: Manufacturer, One Year

- Inserts are carded according to thread size for easy handling and display
- Contained in a vial marked with part number, thread size, and length
- The length of insert in Inch and Metric packages is 1 1/2 times the diameter of the bolt—providing sufficient strength in most applications
- Spark Plug Inserts are packaged in lengths corresponding to the various spark plug reaches

Thread Size	Thread Length	Part Number	Qty.	Thread Size	Thread Length	Part Number	Qty.
Inch Coarse				1 1/8-7	1.688	4C-8429	1
1 1/2-6	2.250	4C-8432	1	1 3/8-6	2.062	4C-8431	1
1 1/4-7	1.875	4C-8430	1	1-8	1.500	4C-8428	1

5 Warranty: Manufacturer, 30-Day

6 Not available for individual sale

Metal Repair

Carded Inserts (Cont'd.)

Thread Size	Thread Length	Part Number	Qty.
1/2-13	.750	4C-8423	6
1/4-20	.375	4C-8419	12
3/4-10	1.125	4C-8426	4
3/8-16	.562	4C-8421	12
5/16-18	.469	4C-8420	12
5/8-11	.938	4C-8425	6
7/16-14	.656	4C-8422	6
7/8-9	1.312	4C-8427	1
9/16-12	.844	4C-8424	6
Inch Fine			
1 1/2-12	2.250	4C-8447	1
1 1/4-12	1.875	4C-8445	1
1 1/8-12	1.688	4C-8444	1
1 3/8-12	2.062	4C-8446	1
1-12	1.500	4C-8443	1
1-14	1.500	4C-8442	1
1/2-20	.750	4C-8438	6
1/4-28	.375	4C-8434	12
3/4-16	1.125	4C-8440	4
3/8-24	.562	4C-8436	12
5/8-15	.938	4C-8439	6
7/16-20	.656	4C-8437	6
7/8-14	1.312	4C-8441	1
9/16-18	.844	4C-8497	6
Metric Coarse			

Thread Size	Thread Length	Part Number	Qty.
M10 x 1.5	15.0	4C-8452	12
M12 x 1.75	18.0	4C-8453	6
M14 x 2	21.0	4C-8454	6
M16 x 2	24.0	4C-8455	6
M18 x 5.25	27.0	4C-8456	6
M20 x 5.25	30.0	4C-8457	3
M5 x 0.8	7.5	4C-8448	12
M6 x 1	9.0	4C-8449	12
M7 x 1	9.0	4C-8450	12
M8 x 1.25	12.0	4C-8451	12
Metric Fine			
M10 x 1	15.0	4C-8459	12
M10 x 1.25	15.0	4C-8460	12
M12 x 1.25	18.0	4C-8461	6
M12 x 1.5	18.0	4C-8462	6
M14 x 1.5	21.0	4C-8463	6
M18 x 1.5	27.0	4C-8465	6
M8 x 1	12.0	4C-8458	12
Spark Plug			
14 - 1.25 mm ⁽⁷⁾	1/2 in	9U-5123	6
14 - 1.25 mm ⁽⁷⁾	3/4 in	9U-5124	6
14 - 1.25 mm ⁽⁷⁾	3/8 in	9U-5121	6
14 - 1.25 mm ⁽⁷⁾	7/16 in	9U-5122	6
18 - 1.50 mm	1/2 in	4C-8466	6

7 Warranty: Manufacturer, 30 Day

Inserts for Specific Engine Applications

Warranty: See individual part number

Engine Bore Size mm (inch)	Drill Size	Thread Size	Tap	Tap Guide	Pre-Winder	Sleeve Assembly	Insert	Nib
95.29 (3.75)	1.0 in			8F-5574		9F-7143		
101.60 (4.00)	1.0 in					9F-7143		
107.95 (4.25)	1 1/8 in		8F-5577	8F-5575		9F-7143	8F-5574	
114.30 (4.50)	1 1/8 in		8F-5577			9F-7143	8F-5574	
101.60 (4.00)	51/64 in	3/4 -12				9F-7143	8M-8292	
114.30 (4.50)	51/74 in	3/4 -12			9F-7143	8M-8292		
114.30 (4.50)	29/32 in	7/8 -12	9M-6595			9F-7143	9M-6593	9M-6596
114.30 (4.50)	29/32 in		9M-6595				8S-6400	

Thread Size x Length	Part Number	Tap Part Number	Installation Tool Part Number
Special Length Inserts			
3/4-16 x 1.500 ⁽⁸⁾	6V-9074	4C-9702	6V-9082
5/8-11 x 1.250 ⁽⁸⁾	6V-9076	4C-9686	6V-9083
M16-2 x 32 mm ⁽⁹⁾	9U-5604	4C-9732	8T-2799
M8-1.25 x 16 mm ⁽⁹⁾	9U-5177	4C-8475	8T-2790

Inserts for Specific Engine Applications

Warranty: Manufacturer, One Year

Engine Bore Size mm (inch)	Drill Size	Thread Size	Tap	Sleeve Assembly	Insert	Nib
120.65 (4.75) V8	29/83 in		9M-6595	8S-6034	8S-6400	
120.65 (4.75) 2-Valve	29/32 in		9M-6595	8S-6034	8S-6400	
130.75 (5.12)	1 1/8 in		8F-5577	9F-7143	5H-8146	
130.75 (5.12) Series F	1.0 in			9F-7143		
137.31 (5.40) D343, 1693 90deltaV8	29/32 in	7/8 - 12	9M-6595	9F-7143	9M-6593	9M-6595
137.31 (5.40) 3400 Series	29/32 in	7/8 - 12	9M-6595	9F-7143	8S-6400	9M-6595
137.31 (5.40) 60deltaV8, V12, V16	29/32 in	7/8 - 12	9M-6595	9F-7143	9M-6593	9M-6595
146.05 (5.75)	1 1/4 in	1 1/4 - 12		9F-7143	8F-5575	
146.05 (5.75)	1 1/8 in	1 1/8 - 12	8F-5577	9F-7143	5H-8146	
158.75 (6.25)	1.0 in	1 - 12		9F-7143	8S-6402	

Insert	Thread Size	Tap Part Number
5H-8146	1 1/8 - 12	8F-5577
8F-5575	1 1/4 - 12 ⁽¹⁰⁾	-
8S-6400	7/8 - 12	9M-6595
8S-6402	1 - 12	-
9M-6593	7/8 - 12 ⁽⁹⁾	9M-6595

8 Warranty: Manufacturer, One Year

9 Warranty: Manufacturer, 30-Day

10 Warranty: Caterpillar, Six Months

Metal Repair

Thread Inserts



Strong, permanent, metal threads — coarse or fine

Master kits contain a selection of various size inserts, drivers, and complete instructions in one package. These master kits provide convenient storage and easy access to inserts and driver tools.

Refill kits contain only one size of thread insert and instructions (no driver tool).

- Installed with standard drills and taps
- No pre-winder tool required
- Impossible to cross thread while installing
- No tang to break-off
- Positive mechanical lock against rotation
- May be used in virtually any material including aluminum, magnesium, cast iron, cold rolled steel, or plastic
- Provides high strength, reliability, and maximum pullout strength
- Easy to remove
- No special skills required—installation procedures can be learned in minutes

Typical Applications

- Buses
- Trucks
- Heavy equipment
- Marine equipment
- Machinery
- Tooling
- Power tools
- Recreational vehicles
- Small engines

Easy Installation/Four Simple Steps

1. Drill out old threads using specified drill size.
2. Tap new threads using specified tap size.
3. Screw in insert until slightly below surface. Lock-tabs act as depth stop.
4. Drive lock-tabs into the surrounding base material with several light taps on installation tool to securely lock the insert against rotation.

English Thread Insert Removal Data			
Internal Thread Size	Drill Size	Drill Depth	Drill Part No.
10-24	9/32 in	3.2 mm (.12 in)	1U-5603
10-32			
1/4 -20	11/32 in	4.8 mm (.19 in)	1U-5607
1/4 -28			
5/16 -18	13/32 in	4.8 mm (.19 in)	1U-5611
5/16 -24			

Thread Inserts (Cont'd.)

English Thread Insert Removal Data			
Internal Thread Size	Drill Size	Drill Depth	Drill Part No.
3/8 -16	15/32 in	4.8 mm (.19 in)	1U-5615
3/8 -24			
7/16 -14	17/32 in	4.8 mm (.19 in)	1U-5682
7/16 -20			
1/2 -13	21/32 in	4.8 mm (.19 in)	1U-5686
1/2 -20			
9/16 -12	21/32 in	4.8 mm (.19 in)	1U-5686
9/16 -18			
5/8 -11	25/32 in	4.8 mm (.19 in)	1U-5690
5/8 -18			
3/4 -10	31/32 in	7.9 mm (.31 in)	1U-5696
3/4 -16			
7/8 -9	1 3/32 in	7.9 mm (.31 in)	1U-5700
7/8 -14			
1-8	1 7/32 in	7.9 mm (.31 in)	—
1-14			
1 1/8 -7	1 11/32 in	7.9 mm (.31 in)	—
1 1/8 -12			
1 1/4 -7	1 15/32 in	7.9 mm (.31 in)	—
1 1/4 -12			
1 1/2 -6	1 23/32 in	7.9 mm (.31 in)	—
1 1/2 -12			
Metric Thread Insert Removal Data			
Internal Thread Size	Drill Size	Drill Depth	Drill Part No.
M6	7.50 mm	4.3 mm (.17 in)	1U-8160
M8	9.50 mm	4.3 mm (.17 in)	1U-8167
M10	11.50 mm	4.3 mm (.17 in)	1U-8171
M12	13.50 mm	4.3 mm (.17 in)	1U-8171
M16	17.75 mm	6.3 mm (.25 in)	—
M20	25.75 mm	6.3 mm (.25 in)	—
M24	28.75 mm	6.3 mm (.25 in)	—

Metal Repair

English and Metric Thread Insert Master Kits



Warranty: Manufacturer, 90 Day

- Solid key-locking inserts are used for repairing damaged threads
- Not affected by vibration or torsion providing added strength and reliability
- All kits are contained in rugged metal boxes with individual compartments for each size of insert and driver
- Each kit contains different-sized inserts and drivers ranging from M6 to M24 or 1/4 inch to 1 1/2 inch threaded size

Reference

Special Instruction SEHS8792, Using Caterpillar Replacement Threads

Part Number	Size Range
247-9662	M6 through M12
247-9663	M8 through M24
9S-3500	#10 through 1 1/2 inch, fine thread
9S-3700	#10 through 1 1/2 inch, course thread

Insert Kits and Replacement Kits



1

Warranty: Manufacturer, 90 Day

Insert Kits (Item 1)

- Used to repair threads of one specific size
- These insert kits include inserts of one size, a driver, and installation instructions
- Insert kits come in both English and metric threads

Replacement Kits (Item 2)

- Replacement kits provide inserts for restocking master kits such as 9S-3500, 9S-3700, 247-9662, and 247-9663
- Kits include one size insert and installation instructions
- Replacements kits come in both English and metric threads

Reference

Special Instruction SEHS8792; Using Caterpillar Replacement Thread Inserts



2

Internal Thread Size	Insert Kit Part Number	Inserts /Kit	Replacement Kit Part Number	External Thread Size	Insert Length	Tap Drill Diameter	Drill Part Number	Countersink Diameter ⁽¹¹⁾	Tap Size	Inserts/ Replacement Kit	Tap Part Number
1 1/2 -12	9S-3638	2	9S-3680	1 7/8 -12	51 mm (2.01 in)	1 13/16	1U-7438	48 mm (1.89 in)	1 7/8 -12	2	—
1 1/2 -6	9S-3637	2	9S-3679	1 7/8 -12	51 mm (2.01 in)	1 13/16	1U-7438	48 mm (1.89 in)	1 7/8 -12	2	—
1 1/4 -12	9S-3636	2	9S-3678	1 5/8 -12	46 mm (1.81 in)	1 9/16	1U-7437	41 mm (1.61 in)	1 5/8 -12	2	1P-3045
1 1/4 -7	9S-3635	2	9S-3677	1 5/8 -12	46 mm (1.81 in)	1 9/16	1U-7437	41 mm (1.61 in)	1 5/8 -12	2	1P-3045
1 1/8 -12	9S-3634	2	9S-3676	1 1/2 -12	41 mm (1.61 in)	1 7/16	1U-5711	39 mm (1.54 in)	1 1/2 -12	3	1P-3044
1 1/8 -7	9S-3633	2	9S-3675	1 1/2 -12	41 mm (1.61 in)	1 7/16	1U-5711	39 mm (1.54 in)	1 1/2 -12	3	1P-3044
1-14	9S-3631	2	9S-3648	1 3/8 -12	35 mm (1.38 in)	1 5/16	1U-5707	35 mm (1.38 in)	1 3/8 -12	4	1P-3043
1-8	9S-3632	2	9S-3658	1 3/8 -12	35 mm (1.38 in)	1 5/16	1U-5707	35 mm (1.38 in)	1 3/8 -12	4	1P-3043

11 Use a standard countersink tool with an angle from 82 to 100 degrees. The diameter listed in the chart is the measurement at the top of the counterbore. The tolerance for this diameter is -0 mm (.0 in) 0.25 mm (.010 in)

Insert Kits and Replacement Kits (Cont'd.)

Internal Thread Size	Insert Kit Part Number	Inserts /Kit	Replacement Kit Part Number	External Thread Size	Insert Length	Tap Drill Diameter	Drill Part Number	Countersink Diameter ⁽¹¹⁾	Tap Size	Inserts/ Replacement Kit	Tap Part Number
1/2 -13	9S-3622	5	9S-3653	3/4 -16	16 mm (0.63 in)	45/64	1U-7435	19 mm (0.75 in)	3/4 -16	15	1P-3036
1/2 -20	9S-3621	5	9S-3643	3/4 -16	16 mm (0.63 in)	45/64	1U-7435	19 mm (0.75 in)	3/4 -16	15	1P-3036
1/4 -20	9U-5053	13	9U-5054	7/16 -14	9.4 mm (0.37 in)	X	1U-5610	11 mm (0.43 in)	7/16 -14	40	1P-3027
1/4 -28	9U-5055	13	9U-5056	7/16 -14	9.4 mm (0.37 in)	X	1U-5610	11 mm (0.43 in)	7/16 -14	40	1P-3027
10-24	9S-3510	15	9S-3674	3/8 -16	7.8 mm (0.31 in)	Q	1U-5606	9.6 mm (0.38 in)	3/8 -16	45	1P-3025
10-32	9S-3509	15	—	3/8 -16	7.8 mm (0.31 in)	Q	1U-5606	9.6 mm (0.38 in)	3/8 -16	45	1P-3025
3/4 -10	9S-3628	2	9S-3656	1 1/8 -12	28 mm (1.10 in)	1 1/16	1U-5699	29 mm (1.14 in)	1 1/8 -12	6	1P-3041
3/4 -16	9S-3627	2	9S-3646	1 1/8 -12	28 mm (1.10 in)	1 1/16	1U-5699	29 mm (1.14 in)	1 1/8 -12	6	1P-3041
3/8 -16	9S-3618	6	9S-3651	9/16 -12	13 mm (0.51 in)	33/64	1U-7433	14 mm (0.55 in)	9/16 -12	20	1P-3031
3/8 -24	9S-3515	6	9S-3641	9/16 -12	13 mm (0.51 in)	33/64	1U-7433	14 mm (0.55 in)	9/16 -12	20	1P-3031
5/16 -18	9U-5057	8	9U-5058	1/2 -13	11 mm (0.43 in)	27/64	1U-5614	13 mm (0.51 in)	1/2 -13	25	1P-3029
5/16 -24	9U-5059	8	9U-5060	1/2 -13	11 mm (0.43 in)	27/64	1U-5614	13 mm (0.51 in)	1/2 -13	25	1P-3029
5/8 -11	9S-3626	2	9S-3655	7/8 -14	22 mm (0.87 in)	53/64	1U-7436	22 mm (0.87 in)	7/8 -14	9	1P-3038
5/8 -18	9S-3625	2	9S-3645	7/8 -14	22 mm (0.87 in)	53/64	1U-7436	22 mm (0.87 in)	7/8 -14	9	1P-3038
7/16 -14	9S-3620	6	9S-3652	5/8 -11	16 mm (0.63 in)	37/64	1U-7434	16 mm (0.63 in)	5/8 -11	18	1P-3033
7/16 -20	9S-3619	6	9S-3642	5/8 -11	16 mm (0.63 in)	37/64	1U-7434	16 mm (0.63 in)	5/8 -11	18	1P-3033
7/8 -14	9S-3629	2	9S-3647	1 1/4 -12	32 mm (1.26 in)	1 3/16	1U-5703	32 mm (1.26 in)	1 1/4 -12	5	1P-3042
7/8 -9	9S-3630	2	9S-3657	1 1/4 -12	32 mm (1.26 in)	1 3/16	1U-5703	32 mm (1.26 in)	1 1/4 -12	5	1P-3042
9/16 -12	9S-3624	3	9S-3654	3/4 -16	20 mm (0.79 in)	45/64	1U-7435	19 mm (0.75 in)	3/4 -16	10	1P-3036
9/16 -18	9S-3623	3	9S-3644	3/4 -16	20 mm (0.79 in)	45/64	1U-7435	19 mm (0.75 in)	3/4 -16	10	1P-3036
M10-1.25	246-7515	5	246-7523	M14-1.5	14 mm (0.55 in)	12.8 mm	1U-8173	14.2 mm (0.56 in)	M14-1.5	10	8T-3093
M10-1.5	246-7514	10	246-7522	M14-1.5	14 mm (0.55 in)	12.8 mm	1U-8173	14.2 mm (0.56 in)	M14-1.5	20	8T-3093
M12-1.75	246-7516	5	246-7524	M16-1.5	16 mm (0.63 in)	14.7 mm	—	16.2 mm (0.64 in)	M16-1.5	10	8T-3095
M16-2	246-7517	3	246-7525	M22-1.5	22 mm (0.87 in)	20.5 mm	—	22.2 mm (0.88 in)	M22-1.5	5	156-8166
M20-2.5	246-7518	3	246-7526	M30-2	30 mm (1.18 in)	28 mm	—	30.2 mm (1.19 in)	M30-2	5	—
M24-3	246-7519	2	246-7528	M33-2	33 mm (1.30 in)	31 mm	—	33.2 mm (1.31 in)	M33-2	5	—
M6-1	246-7511	10	246-7520	M10-1.25	10 mm (0.39 in)	8.8 mm	1U-8165	10.2 mm (0.40 in)	M10-1.25	25	8T-3086
M8-1.25	246-7513	10	246-7521	M12-1.25	12 mm (0.47 in)	10.8 mm	1U-8169	12.2 mm (0.48 in)	M12-1.25	25	8T-3089

11 Use a standard countersink tool with an angle from 82 to 100 degrees. The diameter listed in the chart is the measurement at the top of the counterbore. The tolerance for this diameter is -0 mm (.0 in) 0.25 mm (.010 in)

Metal Repair

Installation Tools and Thread Inserts

SMCS Code: 7564

Models: 141-7250-416C, 426C, 428C, 436C, and 438C Backhoe Loader; 178-7635—E529, E523, E530, E524, E531, E525, and various other models; 179-3571-various

Warranty: Caterpillar Standard Warranty, 6 Months

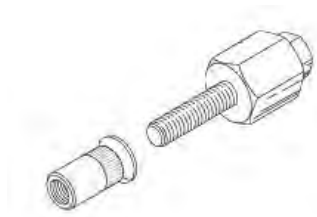

141-7250 Installation Tool

- Used to install M6 x 1 threaded insert
- Used with standard hand tools to make repair
- Allows convenient field repair of stripped or damaged threads
- Compact design allows installation of insert in confined areas
- Used in applications such as repair of threaded M6 x 1.0 mounting holes inside cab of C-Series Backhoe Loaders

140-9921 Threaded Insert

- Used to repair stripped threads
- Used in material thickness of 0.7 to 3.0 mm (.028 to .118 in)

178-7635 Installation Tool

- Used to install 8-32 threaded insert
- Used with standard hand tools to make repair
- Allows convenient field repair of stripped or damaged threads
- Compact design allows installation of insert in confined areas

176-1691 Fastener

- Used to repair stripped threads
- Used in material thickness of .76 mm to 4.75 mm (.030 to .187 in)

179-3571 Installation Tool

- Used to install all 1/4 -20 threaded insert
- Used with standard hand tools to make repair
- Allows convenient field repair of stripped or damaged threads
- Compact design allows installation of inserts in confined area

178-1628 Fastener

- Used to repair stripped threads
- Used in material thickness of .76 mm to 4.75 mm (.030 to .187 in)

Reference

NEHS0677 Tool Operating Manual containing installation instructions

Part Number	Description	Hex Size	Length	Bolt Thread	Body Diameter	Flange Diameter	Thread
Installation Tools							
141-7250	Installation Tool	9/16 in	12.7 mm (0.50 in)	M6 x 1.0	—	—	—
178-7635	Installation Tool	9/16 in	10.2 mm (0.40 in)	8-32	—	—	—
179-3571	Installation Tool	9/16 in	13.3 mm (0.52 in)	1/4 -20	—	—	—
206-4496	Installation Tool (M4)	9/16 in	12.7 mm (0.50 in)	M4 x 0.7	—	—	—
206-4499	Installation Tool (M6)	9/16 in	12.7 mm (0.50 in)	M6 x 1.0	—	—	—

Installation Tools and Thread Inserts (Cont'd.)

Part Number	Description	Hex Size	Length	Bolt Thread	Body Diameter	Flange Diameter	Thread
Threaded Inserts							
140-9921	Threaded Insert	–	14.0 mm (0.55 in)	–	9.5 mm (0.37 in)	10.0 mm (0.39 in)	M6 x 1.0
176-1691	Fastener	–	9.4 mm (0.37 in)	–	6.3 mm (0.25 in)	6.8 mm (0.27 in)	8-32
178-1628	Threaded Insert	–	13.1 mm (0.52 in)	–	9.5 mm (0.37 in)	10.2 mm (0.40 in)	1/4 -20

Weld Wire

Warranty: Manufacturer

- Advanced Surface Characteristics Technology
- Improved feedability and arc starting/stability
- Superb wetting action
- Extended corrosion resistance
- Reduced contact tip wear
- Classifications/Approvals: DNV III YMS, CWB CSA W48: ER49S-6, BV SA3YM, ABS 3SA, 3YSA, DB 42.039.29, AWS SFA5.18: ER70S-6, GL 3YS, LR 3S 3YS, VdTUV 10052
- Available in Canada, Mexico, and the United States



Typical Mechanical Properties	
90% Ar/10% CO₂	
Yield Strength	66 ksi, 455 Mpa
Tensile Strength	82 ksi, 565 Mpa
Elongation in 2"	27%
Reduction of Area	56%
CVN (@-20°F)	82 ft-lbs, 111J
75% Ar/25% CO₂	
Yield Strength	66 ksi, 455 Mpa
Tensile Strength	82 ksi, 565 Mpa
Elongation in 2"	28%
Reduction of Area	61%
CVN (@-20°F)	44 ft-lbs, 111J
100% CO₂	
Yield Strength	65 ksi, 448 Mpa
Tensile Strength	78 ksi, 538 MPa
Elongation in 2"	25%
Reduction of Area	70%
CVN (@-20°F)	27 ft-lbs, 37 J

Part Number	432-6084	416-2693	432-6083	432-6087	432-6085	432-6086
Aristorod 12.5 mild steel MIG welding wire						
Quantity	1050 lbs (476 kg)	550 lbs (250 kg)	40 lbs (18 kg)	900 lbs (408 kg)	550 lbs (250 kg)	40 lbs (18 kg)

Metal Repair

Weld Wire (Cont'd.)

Part Number	432-6084	416-2693	432-6083	432-6087	432-6085	432-6086
Gauge	0.045	0.045	0.045	0.035	0.035	0.035
Minimum	2	4	63	2	4	63

Cap and Plug Kit - 276-7018



Warranty: Cat Standard Warranty, 6 Months

- Protects against damage, dirt, moisture and corrosion during storage, shipping and repair
- Tapered caps/plugs are designed to plug multiple inner diameters and cap multiple outside diameters
- Three individual plastic boxes all found in one kit to keep caps/plugs organized and clean

276-7018 Consists of:	
Part Number	Index Description
276-0731	Cap-Plug
276-0740	Cap-Plug
276-0741	Cap-Plug
276-0742	Cap-Plug
276-0743	Cap-Plug
276-0744	Cap-Plug
276-0745	Cap-Plug
276-0746	Cap-Plug
276-0747	Cap-Plug
276-0748	Cap-Plug
276-0749	Cap-Plug
276-0750	Cap-Plug
276-0751	Cap-Plug
276-0752	Cap-Plug

276-7018 Consists of:	
Part Number	Index Description
276-0753	Cap-Plug
276-0754	Cap-Plug
276-0755	Cap-Plug
276-0756	Cap-Plug
276-0757	Cap-Plug
7E-8716	Cap-Plug
9U-7067	Cap/Plug - Tapered
9U-7068	Cap/Plug - Tapered
9U-7069	Cap/Plug - Tapered
9U-7070	Cap/Plug - Tapered
9U-7071	Cap/Plug - Tapered
9U-7073	Cap/Plug - Tapered
9U-7074	Cap/Plug - Tapered
9U-7075	Cap/Plug - Tapered

276-7018 Consists of:	
Part Number	Index Description
9U-7076	Cap/Plug - Tapered
9U-7077	Cap/Plug - Tapered
9U-7078	Cap/Plug - Tapered
9U-7079	Cap/Plug - Tapered
9U-7080	Cap/Plug - Tapered
9U-7081	Cap/Plug - Tapered
9U-7082	Cap/Plug - Tapered
9U-7085	Cap/Plug - Tapered
9U-7087	Cap/Plug - Tapered
9U-7088	Cap/Plug - Tapered
9U-7089	Cap/Plug - Tapered
9U-7090	Cap/Plug - Tapered
9U-7091	Cap/Plug - Tapered

Conduit Covers



Warranty: Caterpillar Standard Warranty, 6 months

- Quick and easy to use
- Polyethylene nylon
- Built in quick tie
- Universal size
- Pack of 50

Conduit Covers	
435-9843	4 x 5 inch (102 x 127 mm)
435-9844	8 x 8 inch (203 x 203 mm)
435-9845	12 x 12 inch (305 x 305 mm)

Caps and Plugs

ORFS Plugs

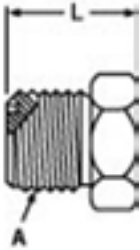

Warranty: Cat Standard Warranty, 6 Months

- Used to help protect against damage, dirt and moisture contamination, and corrosion during shipping and storage

Part Number	Thread Dash Size (A)	Thread Size (A) (in - TPI)	L Length
231-3942	-24 ⁽¹⁾	2-12	1.10 in, 28 mm
6V-9507	-4	9/16 - 18	0.67 in, 17 mm
6V-9508	-6	11/16 - 16	0.75 in, 19 mm
6V-9509	-8	13/16 - 16	0.87 in, 22 mm
6V-9510	-10	1 - 14	1.02 in, 26 mm
6V-9511	-12	1 3/16 - 12	1.06 in, 27 mm
6V-9512	-16	1 7/16 - 12	1.10 in, 28 mm
6V-9513	-20	1 11/16 - 12	1.10 in, 28 mm

JIC 37° Plugs

Warranty: Cat Standard Warranty, 6 Months

- Used to help protect against damage, dirt and moisture contamination, and corrosion during shipping and storage

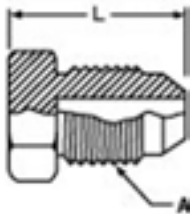

Part Number	Thread Dash Size (A)	Thread Size (A) (in - TPI)	L Length (In)
2P-9697	-10	7/8 - 14	1.10
5P-2299	-16	1 5/16 - 12	1.34
5P-2909	-8	3/4 - 16	0.94
5P-4299	-14	1 3/16 - 12	1.30
5P-4996	-5	1/2 - 20	0.79
9S-5518	-4	7/16 - 20	0.79
9S-8895	-12	1 1/16 - 12	1.26
9S-8927	-6	9/16 - 18	0.83

¹ Warranty: Six Months

Straight Thread O-Ring - Hex Head Plugs



Warranty: Cat Standard Warranty, 6 Months

- Used to help protect against damage, dirt and moisture contamination, and corrosion during shipping and storage

Part Number	Thread Size (in - TPI)	O-Ring Seal
1N-5998	1 7/8 - 12	6K-6307
1N-5999	3/8 - 24	7J-0204
3K-8460	1/2 - 20	1J-9671
9S-4180	5/16 - 24	4J-7533
9S-4181	1 5/16 - 12	7M-8485
9S-4182	7/16 - 20	3J-7354
9S-4183	1 1/16 - 12	3D-2824

Part Number	Thread Size (in - TPI)	O-Ring Seal
9S-4185	3/4 - 16	3K-0360
9S-4188	1 3/16 - 12	4K-1388
9S-4190	7/8 - 14	2M-9780
9S-4191	9/16 - 18	3J-1907
9S-6130	1 5/8 - 12	2S-4078
9S-7583	2 1/2 - 12	030-4606

Straight Thread O-Ring - Hex Drive Plugs



Warranty: Cat Standard Warranty, 6 Months

- Used to help protect against damage, dirt and moisture contamination, and corrosion during shipping and storage

Part Number	Thread Size (in - TPI)	O-Ring Seal
5P-7684	1 7/8 - 12	6K-6307
9S-8001	5/16 - 24	4J-7533
9S-8002	7/16 - 20	3J-7354
9S-8003	1/2 - 20	1J-9671
9S-8004	9/16 - 18	3J-1907
9S-8005	3/4 - 16	3K-0360

Part Number	Thread Size (in - TPI)	O-Ring Seal
9S-8006	7/8 - 14	2M-9780
9S-8007	3/8 - 24	7J-0204
9S-8008	1 1/16 - 12	3D-2824
9S-8009	1 3/16 - 12	4K-1388
9S-8010	1 5/8 - 12	2S-4078
9S-9334	1 5/16 - 12	7M-8485

Pipe - Hex Head Plugs



Warranty: Cat Standard Warranty, 6 Months

- Used to help protect against damage, dirt and moisture contamination, and corrosion during shipping and storage

Part Number	Thread Size (in - TPI)
090-9019	1 - 11 1/2
2S-7905	1/16 - 27
3J-5390	3/8 - 18
3M-7045	3/4 - 14

Part Number	Thread Size (in - TPI)
4J-4382	1/2 - 14
5M-6213	1/4 - 18
5M-6214	1/8 - 27

Caps and Plugs

Pipe - Square Head Plugs



Warranty: Cat Standard Warranty, 6 Months

- Used to help protect against damage, dirt and moisture contamination, and corrosion during shipping and storage

Part Number	Thread Size (in - TPI)
068-0710	1 1/4 - 11 1/2
2B-7408	1/8 - 27
2B-7409	1/4 - 18
2B-7457	3/8 - 18

Part Number	Thread Size (in - TPI)
5B-9169	1/2 - 14
5P-3320	3/4 - 14
7L-2505	1 - 11 1/2

Pipe - Square Drive Plugs



Warranty: Cat Standard Warranty, 6 Months

- Used to help protect against damage, dirt and moisture contamination, and corrosion during shipping and storage

Part Number	Thread Size (in - TPI)
1B-5170	1 1/4 - 11 1/2
1B-5174	3/4 - 14
2B-0858	1/2 - 14
3B-0551	1 - 11 1/2
4B-4845	3/8 - 18

Part Number	Thread Size (in - TPI)
6V-1897	2 - 11 1/2
6V-3280	2 1/2 - 8
7B-9665	1 1/2 - 11 1/2
7F-9504	1/4 - 18

Pipe - Hex Drive Plugs

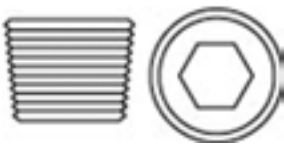

Warranty: Cat Standard Warranty, 6 Months

- Used to help protect against damage, dirt and moisture contamination, and corrosion during shipping and storage

Part Number	Thread Size (in - TPI)
2R-5657	1 - 11 1/2
4D-0514	1/16 - 27
7H-3171	1/4 - 18

Part Number	Thread Size (in - TPI)
7M-7410	3/8 - 18
9F-2247	1/8 - 27

JIS - BSPP Shipping Plugs

Warranty: Cat Standard Warranty, 6 Months

- Used to help protect against damage, dirt and moisture contamination, and corrosion during shipping and storage

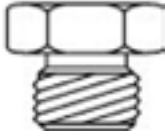

Part Number	JIS-BSPP Thread Size (in - TPI)
093-1321	1/4 - 19
093-1322	1/2 - 14
093-1323	3/4 - 14
096-3829	1 - 11
096-6073	3/8 - 19

Metric Plugs

Warranty: Cat Standard Warranty, 6 Months

- Used to help protect against damage, dirt and moisture contamination, and corrosion during shipping and storage

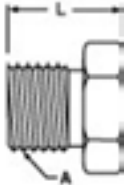

Part Number	Light Duty Tube O.D. (mm)	Heavy Duty Tube O.D. (mm)	L Length (In) (mm)
2Y-5841	10	8	0.63 in, 16 mm
2Y-6461	10	8	0.71 in, 18 mm
2Y-6462	8	6	0.63 in, 16 mm
8C-4424	14	14	1.06 in, 27 mm
9T-6322	8	6	0.87 in, 22 mm

SAE Code 61 Flange Port Cover

Warranty: Cat Standard Warranty, 6 Months

- Used to help protect against damage, dirt and moisture contamination, and corrosion during shipping and storage



Part Number	Head Size (A) (in)	Flange (mm)
2J-2668	2.38	60.3
2J-5608	2.81	71.4
5H-4017	1.19	30.2
5H-4018	1.50	38.1
5H-4019	1.75	44.5
5H-4020	2.00	50.8

Caps and Plugs

Cat Flange Port Cover

Warranty: Cat Standard Warranty, 6 Months

- Used to help protect against damage, dirt and moisture contamination, and corrosion during shipping and storage



Part Number	Head Size (A) (in)	Flange (mm)
5P-0045	1.25	31.8
5P-0046	1.63	41.3
5P-0047	1.88	47.6
5P-0048	2.12	54.0
5P-0049	2.50	63.5
5P-0050	3.13	79.4

Tapered Dual-Function Caps and Plugs

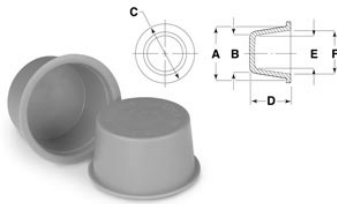

Warranty: Cat Standard Warranty, 6 Months

To assure a proper fit, dimension "E" should be approximately .020 in smaller than the opening diameter of the part to be protected, or dimension "A" should be approximately .020 in larger than the opening diameter of the part to be protected.

- The tapered design allows the part to plug multiple inner diameters or cap multiple outside diameters
- Protects against damage, dirt, moisture and corrosion during storage and shipping
- Material: Low-Density Polyethylene
- Color: Blue
- Applicable Spec: NAS 834 (supercedes MIL-C-5501/7, MIL-C-52078)
- Tapered Dual-Function Caps and Plugs

Part Number	Package Quantity	Length (A) (in)	Length (A) (mm)	Length (B) (in)	Length (B) (mm)	Length (C) (in)	Length (C) (mm)	Length (D) (in)	Length (D) (mm)	Length (E) (in)	Length (F) (in)	Supplier Part Number
Tapered Dual-Function Caps and Plugs												
276-0731	250	0.18	5	0.11	3	0.31	8	0.40	10	0.05	0.11	1 T-0-X
276-0740	250	0.24	6	0.17	4	0.37	10	0.37	10	0.10	0.17	2 T-1
276-0741	250	0.27	7	0.20	5	0.43	11	0.37	10	0.15	0.20	4 T-1-X
276-0742	250	0.30	8	0.24	6	0.46	12	0.37	10	0.17	0.24	5 T-2
276-0743	250	0.33	9	0.26	7	0.46	12	0.37	10	0.20	0.27	6 T-2-X
276-0744	250	0.36	9	0.30	8	0.53	13	0.37	10	0.23	0.30	7 T-3
276-0745	250	0.46	12	0.39	10	0.62	16	0.37	10	0.32	0.39	10 T-4-X
276-0746	250	0.51	13	0.44	11	0.62	16	0.40	10	0.38	0.44	12 T-5-X
276-0747	250	0.56	14	0.50	13	0.75	19	0.43	11	0.43	0.50	14 T-6-X
276-0748	250	0.67	17	0.58	15	0.87	22	0.53	13	0.52	0.60	18 T-8-X
276-0749	250	0.69	18	0.61	15	0.84	21	0.50	13	0.54	0.63	20 T-9
276-0750	250	0.93	24	0.82	21	1.12	29	0.62	15	0.75	0.86	29 T-13-A
276-0751	250	1.35	34	1.22	31	1.50	38	0.75	19	1.16	1.29	45 T-16
276-0752	250	1.45	40	1.29	33	1.62	41	1.00	25	1.22	1.39	48 T-17
276-0753	250	1.46	37	1.31	33	1.62	41	0.75	19	1.24	1.40	49 T-17
276-0754	100	1.75	44	1.60	41	1.93	49	0.75	19	1.56	1.68	56 T-19
276-0755	100	2.02	51	1.84	47	2.12	54	1.00	25	1.78	1.93	60 T-22-S
276-0756	100	2.16	55	1.98	50	2.25	57	1.00	25	1.91	2.11	63 T-25-A
276-0757	100	2.25	57	2.06	52	2.43	62	1.03	26	2.00	2.17	66 T-240

Tapered Dual-Function Caps and Plugs (Cont'd.)

Part Number	Package Quantity	Length (A) (in)	Length (A) (mm)	Length (B) (in)	Length (B) (mm)	Length (C) (in)	Length (C) (mm)	Length (D) (in)	Length (D) (mm)	Length (E) (in)	Length (F) (in)	Supplier Part Number
Tapered Dual-Function Caps and Plugs												
276-0758	50	2.60	66	2.39	61	2.62	67	1.00	25	2.33	2.54	73 T-44
276-0759	50	2.69	68	2.56	65	2.87	73	0.75	19	2.50	2.62	77 T-44
276-0760	50	3.24	82	2.98	76	3.37	86	1.00	25	2.90	3.16	85 T-501
276-0761	50	3.75	95	3.55	90	4.00	102	1.00	25	3.47	3.67	K-851 T-502
276-0762	50	3.92	100	3.80	97	4.12	105	0.68	17	3.71	3.84	91 T-1063
6V-7494	50	3.00	76	2.74	70	3.13	79	1.00	25	2.68	2.94	81 T-57-A
6V-7496	50	4.62	117	4.37	111	5.00	127	1.00	25	4.29	4.50	95 T-1076
9U-7067	250	0.40	10	0.33	8	0.56	14	0.38	10	0.27	0.33	8 T-3-X
9U-7068	250	0.43	11	0.36	9	0.59	15	0.38	10	0.30	0.37	9 T-4
9U-7069	250	0.49	12	0.42	11	0.59	15	0.38	10	0.36	0.42	11 T-5
9U-7070	250	0.55	14	0.49	12	0.72	18	0.50	13	0.41	0.49	13 T-6-5
9U-7071	250	0.62	16	0.53	13	0.75	19	0.50	13	0.47	0.55	16 T-7-X
9U-7072	250	0.63	16	0.55	14	0.78	20	0.50	13	0.49	0.57	17 T-8
9U-7073	250	0.73	18	0.64	16	0.88	22	0.50	13	0.58	0.67	21 T-9-X
9U-7074	250	0.75	19	0.67	17	0.88	22	0.63	16	0.62	0.69	22 T-10
9U-7075	250	0.79	20	0.69	18	0.94	24	0.63	16	0.63	0.72	23 T-11
9U-7076	250	0.85	22	0.75	19	1.03	26	0.63	16	0.69	0.79	27 T-12
9U-7077	250	0.91	23	0.80	20	1.09	28	0.75	19	0.74	0.85	28 T-12-X
9U-7078	250	0.98	25	0.87	22	1.11	28	0.63	16	0.81	0.92	31 T-13-X
9U-7079	250	1.04	26	0.90	23	1.16	29	0.75	19	0.83	0.98	35 T-14
9U-7080	250	1.09	28	0.97	25	1.25	32	0.75	19	0.90	1.03	40 T-14
9U-7081	250	1.15	29	1.00	25	1.31	33	0.75	19	0.94	1.08	41 T-14-X
9U-7082	250	1.23	31	1.11	28	1.52	39	0.75	19	1.04	1.18	42 T-15-X
7E-8716	250	1.29	33	1.18	30	1.44	37	0.75	19	1.11	1.22	44 T-15-5
276-0751	250	1.35	34	1.22	31	1.50	38	0.75	19	1.16	1.29	45 T-16
9U-7084	250	1.35	34	1.24	31	1.50	38	0.75	19	1.17	1.30	46 T-16
9U-7085	250	1.60	41	1.45	37	1.75	44	0.75	19	1.39	1.54	53 T-18
9U-7086	100	1.60	41	1.52	39	1.75	44	0.75	19	1.46	1.54	54 T-18-X
9U-7087	100	1.68	43	1.56	40	1.88	48	0.75	19	1.50	1.62	55 T-19
9U-7088	100	1.88	48	1.75	44	2.03	52	0.75	19	1.69	1.82	57 T-210
9U-7089	100	1.94	49	1.81	46	2.13	54	1.00	25	1.75	1.88	58 T-21
9U-7090	50	2.26	57	2.23	57	2.50	64	0.50	13	2.17	2.20	68 T-240
9U-7091	50	2.47	63	2.30	58	2.63	67	1.00	25	2.24	2.40	71 T-43-A
9U-7092	50	2.79	71	2.65	67	3.00	76	0.50	13	2.58	2.73	78 T-45-A
9U-7094	50	3.45	88	3.32	84	3.63	92	0.50	13	3.24	3.37	87 T1050
9U-7095	50	3.58	91	3.24	82	3.94	100	1.00	25	3.16	3.49	88 T1051
9U-7096	50	4.46	113	4.22	107	5.00	127	1.00	25	4.14	4.38	94 T1076

Caps and Plugs

Straight Cap

Warranty: Cat Standard Warranty, 6 Months



Part Number	Package Quantity	Material	Length (A) (in)	Length (A) (mm)	Length (B) (in)	Length (B) (mm)	Length (C) (in)	Length (C) (mm)	Length (D) (in)	Length (D) (mm)	Length (E) (in)
217-1591	50	1	1.25	31.65	0.67	17	1	25.22	1.06	26.82	0.05

Non-threaded Caps

Warranty: Cat Standard Warranty, 6 Months

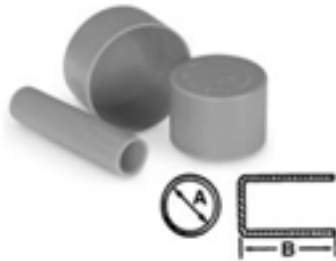

Part Number	Package Quantity	Material ⁽²⁾	Diameter (A) (in)	Length (B) (in)	Length (B) (mm)
9U-7166	250	1	0.13	0.63	16
9U-7167	250	1	0.25	0.88	22
9U-7168	250	1	0.30	0.88	22
9U-7169	250	1	0.38	0.88	22
9U-7170	250	1	0.44	0.88	22
9U-7171	250	1	0.50	0.88	22
9U-7172	250	1	0.56	0.88	22
9U-7173	250	1	0.63	0.88	22
9U-7174	100	1	0.69	0.88	22
9U-7175	100	1	0.75	0.88	22
9U-7176	100	1	0.81	0.88	22
9U-7177	100	1	0.88	0.88	22
9U-7178	100	1	1.00	0.75	19
9U-7179	100	1	1.06	0.88	22
9U-7180	100	1	1.19	1.00	25
9U-7181	100	1	1.25	0.88	22
9U-7182	100	1	1.31	0.88	22
9U-7183	100	1	1.38	0.88	22
9U-7184	100	1	1.44	0.88	22
9U-7185	100	1	1.50	0.88	22
9U-7186	100	1	1.63	1.00	25
9U-7187	100	1	1.69	0.88	22
9U-7188	100	1	1.75	0.88	22
9U-7189	100	1	1.88	0.88	22
9U-7190	100	1	2.00	0.88	22
9U-7191	100	1	2.13	0.88	22
9U-7192	100	1	2.38	0.88	22
9U-7193	100	1	2.50	0.88	22
9U-7194	50	1	3.13	1.38	35

2 1: Grade 1 Virgin Polyethylene
 2: Low Density Polyethylene
 3: High Density Polyethylene

Metric Threaded Cap Protectors

Warranty: Cat Standard Warranty, 6 Months

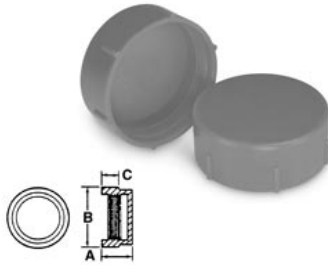

Part Number	Package Quantity	Material ⁽³⁾	Diameter x Pitch	Length (A) (in)	Length (A) (mm)	Length (B) (in)	Length (B) (mm)	Length (C) (in)	Length (C) (mm)
9U-7145	100	2	M10 x 1.0	0.39	10	0.54	14	0.29	8
9U-7146	100	2	M12 x 1.5	0.47	12	0.62	16	0.37	10
9U-7147	100	2	M14 x 1.5	0.47	12	0.70	18	0.37	10
9U-7148	100	2	M16 x 1.5	0.47	12	0.78	20	0.37	10
9U-7149	100	2	M18 x 1.5	0.55	14	0.85	22	0.45	12
9U-7150	100	2	M20 x 1.5	0.55	14	0.92	24	0.37	10
9U-7151	50	2	M22 x 1.5	0.54	14	1.02	26	0.45	12
9U-7152	50	2	M24 x 1.5	0.55	14	1.14	29	0.45	12
9U-7153	50	2	M26 x 1.5	0.55	14	1.18	30	0.45	12

Metric Threaded Plug Protectors

Warranty: Cat Standard Warranty, 6 Months



Part Number	Package Quantity	Material ⁽³⁾	Diameter x Pitch	Length (A) (in)	Length (A) (mm)	Length (B) (in)	Length (B) (mm)	Length (C) (in)	Length (C) (mm)
9U-7136	100	2	M10 x 1.0	0.57	15	0.60	15	0.41	10
9U-7137	100	2	M12 x 1.0	0.66	17	0.73	19	0.42	11
9U-7138	50	2	M14 x 1.5	0.68	17	0.73	19	0.37	10
9U-7139	50	2	M16 x 1.5	0.68	17	0.87	22	0.50	13
9U-7140	50	2	M18 x 1.5	0.72	18	0.96	24	0.54	14
9U-7141	50	2	M20 x 1.5	0.72	18	1.04	26	0.55	14
9U-7142	50	2	M22 x 1.5	0.72	18	1.11	28	0.54	14
9U-7143	50	2	M24 x 1.5	0.73	19	1.23	31	0.54	14
9U-7144	50	2	M26 x 1.5	0.73	19	1.46	37	0.54	14

3
 1: Grade 1 Virgin Polyethylene
 2: Low Density Polyethylene
 3: High Density Polyethylene

Caps and Plugs

Threaded Plug Protectors for Flared Fittings

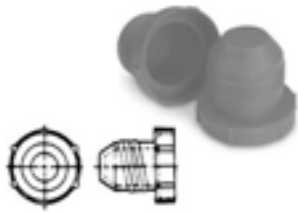

Warranty: Cat Standard Warranty, 6 Months

Part Number	Package Quantity	Material ⁽⁴⁾	Thread Size (in - TPI)	Tube Diameter (in)
9U-7114	250	1	7/16 - 20	0.25
9U-7115	250	1	9/16 - 18	0.38
9U-7116	250	1	3/4 - 16	0.50
9U-7117	100	1	7/8 - 14	0.63
9U-7118	100	1	11/16 - 12	0.75
9U-7119	100	1	15/16 - 12	1.00

Threaded and Slotted Plug Protectors

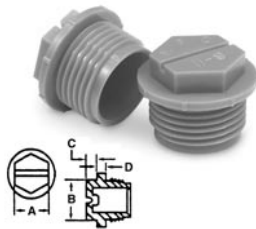

Warranty: Cat Standard Warranty, 6 Months

Part Number	Package Quantity	Material ⁽⁴⁾	Thread Size (in - TPI)	Tube Diameter (in)	Length (A) (in)	Length (A) (mm)	Length (B) (in)	Length (B) (mm)	Length (C) (in)	Length (C) (mm)	Length (D) (in)	Length (D) (mm)
9U-7104	250	3	7/16 - 20	-	0.43	11	0.62	11	0.18	5	0.30	5
9U-7105	100	3	1/2 - 20	-	0.50	13	0.68	13	0.18	5	0.36	5
9U-7106	100	3	9/16 - 18	-	0.50	13	0.75	13	0.18	5	0.33	5
9U-7107	100	3	3/4 - 16	-	0.68	17	0.94	17	0.19	5	0.44	5
9U-7108	100	3	7/8 - 14	-	0.75	19	1.06	19	0.24	6	0.50	6
9U-7109	100	3	11/16 - 14	-	0.87	22	1.31	22	0.25	6	0.62	6
9U-7110	50	3	13/16 - 12	-	1.00	25	1.50	25	0.30	8	0.70	8
9U-7111	50	3	15/16 - 12	1.00	1.07	27	1.62	27	0.30	8	0.70	8
9U-7112	50	3	1 5/8 - 12	-	1.13	29	1.88	29	0.30	8	0.75	8
9U-7113	50	3	1 7/8 - 12	-	1.50	38	2.13	38	0.30	8	0.75	8

Plug Protectors for NPT Thread - Square Head

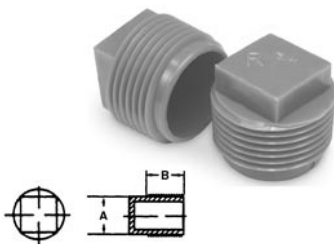

Warranty: Cat Standard Warranty, 6 Months

- 4
- 1: Grade 1 Virgin Polyethylene
 - 2: Low Density Polyethylene
 - 3: High Density Polyethylene

Plug Protectors for NPT Thread - Square Head (Cont'd.)

Part Number	Package Quantity	Material ⁽⁵⁾	Thread Size (in - TPI)	Length (A) (in)	Length (A) (mm)	Length (B) (in)	Length (B) (mm)
9U-7098	250	3	1/8 - 27	0.28	7	0.38	10
9U-7099	250	3	1/4 - 18	0.38	10	0.44	11
9U-7100	250	3	3/8 - 18	0.44	11	0.50	13
9U-7101	250	3	1/2 - 14	0.56	14	0.56	14
9U-7102	100	3	3/4 - 14	0.69	17	0.63	16

Plug Protectors for NPT Thread - Knurled Head

Warranty: Cat Standard Warranty, 6 Months

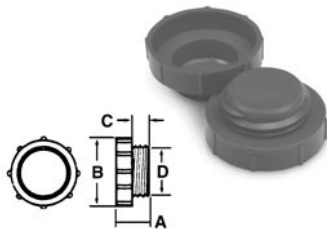

Part Number	Package Quantity	Material ⁽⁵⁾	Thread Size (in - TPI)	Length (A) (in)	Length (A) (mm)	Length (B) (in)	Length (B) (mm)	Length (C) (in)	Length (C) (mm)	Length (D) (in)	Length (D) (mm)
9U-7103	100	3	1 - 11 1/2	0.50	13	1.57	40	0.25	6	1.18	30

5
 1: Grade 1 Virgin Polyethylene
 2: Low Density Polyethylene
 3: High Density Polyethylene

Caps and Plugs

Tear Cap Protectors for Standard Thread

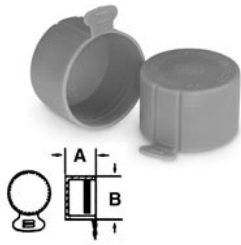

Warranty: Cat Standard Warranty, 6 Months

Part Number	Package Quantity	Material ⁽⁶⁾	Thread Size (in - TPI)	JIC/SAE Fitting	Length (A) (in)	Length (A) (mm)	Length (B) (in)	Length (B) (mm)
9U-7120	250	1	7/16 - 20	4-TS	0.46	12	0.43	11
9U-7121	250	1	1/2 - 20	5-TS	0.46	12	0.49	12
9U-7122	250	1	9/16 - 18	6-TS	0.48	12	0.55	14
9U-7123	250	1	11/16 - 16	7-TS	0.48	12	0.67	17
9U-7124	250	1	3/4 - 16	8-TS	0.56	14	0.74	19
9U-7125	250	1	13/16 - 16	9-TS	0.56	14	0.80	20
9U-7126	250	1	7/8 - 14	10-TS	0.65	17	0.87	22
9U-7127	250	1	1 - 14	11-TS	0.65	17	0.99	25
9U-7128	250	1	1 1/16 - 12	12-TS	0.75	19	1.05	27
9U-7129	250	1	1 3/16 - 12	13-TS	0.75	19	1.17	30
9U-7130	100	1	1 5/16 - 12	16-TS	0.75	19	1.30	33
9U-7131	100	1	1 7/16 - 12	17-TS	0.75	19	1.43	36
9U-7132	100	1	1 9/8 - 12	20-TS	0.83	21	1.62	41
9U-7133	100	1	1 11/16 - 12	21-TS	0.83	21	1.67	42
9U-7134	100	1	1 7/8 - 12	24-TS	0.95	24	1.87	48
9U-7135	50	1	2 1/2 - 12	32-TS	1.20	30	2.49	63

SAE Code Flange 61 Bolted Protectors

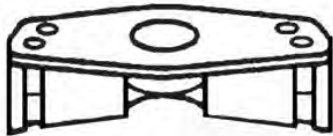

Warranty: Cat Standard Warranty, 6 Months

Part Number	Package Quantity	Material ⁽⁶⁾	Thread Size (in - TPI)
9U-7154	25	1	1/2 NPT
9U-7155	25	1	3/4 NPT
9U-7156	25	1	1 NPT
9U-7157	25	1	1 1/4 NPT
9U-7158	25	1	1 1/2 NPT
9U-7159	25	1	2 NPT
9U-7160	25	1	2 1/2 NPT

6 1: Grade 1 Virgin Polyethylene
 2: Low Density Polyethylene
 3: High Density Polyethylene

British Thread - BSP/GAS Plug Protectors

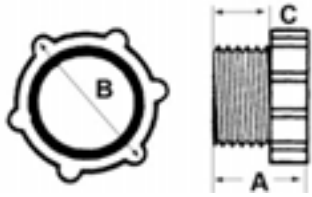

Warranty: Cat Standard Warranty, 6 Months

Part Number	Package Quantity	Material ⁽⁷⁾	Thread Size (in - TPI)	Length (A) (in)	Length (A) (mm)	Length (B) (in)	Length (B) (mm)	Length (C) (in)	Length (C) (mm)
9U-7195	100	2	1/8 - 28	0.41	11	0.65	16	0.16	4
9U-7196	100	2	1/4 - 19	0.50	13	0.74	19	0.26	7
9U-7197	100	2	3/8 - 19	0.47	12	0.90	23	0.27	6
9U-7198	100	2	1/2 - 14	0.68	17	1.10	28	0.41	10
9U-7199	50	2	5/8 - 14	0.72	18	1.23	31	0.51	13
9U-7200	50	2	3/4 - 14	0.67	17	1.27	32	0.43	11
9U-7201	50	2	7/8 - 14	0.71	18	1.50	38	0.53	14
9U-7202	50	2	1 - 11	0.66	17	1.57	40	0.42	11

SAE Code 62 and Caterpillar Flange Bolted Protectors

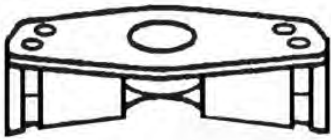

Warranty: Cat Standard Warranty, 6 Months

Part Number	Package Quantity	Material ⁽⁷⁾	Thread Size (in - TPI)
9U-7161	25	1	3/4 NPT
9U-7162	25	1	1 NPT
9U-7163	25	1	1 1/4 NPT
9U-7164	25	1	1 1/2 NPT
9U-7165	25	1	2 NPT

7
 1: Grade 1 Virgin Polyethylene
 2: Low Density Polyethylene
 3: High Density Polyethylene

Vises

Tradesman Vises



Warranty: Manufacturer, Lifetime

- Replaceable, hardened steel serrated jaw inserts and replaceable pipe jaws
- Precision, machined keyed slide bar
- Built for maximum quality and performance
- Straight line design means no wear on spindle or nut
- 360° swivel base, double lockdowns
- Side play eliminated by precision machined slide bar—keyed for precision
- Fully enclosed design keeps dirt and contaminants out

Part Number	Jaw Width	Pipe Capacity	Throat Depth	Max. Opening Width	Shipping Weight	Replacement Jaw Insert Kits	Replacement Pipe Jaw Inserts	Replacement Jaw Insert
188-2163	8	1/8 in- 3 1/2 in	4 3/4 in	7 in	109.0 lb	–	–	–
233-8145	4	1/4 in-2 in	3 7/16 in	4 1/2 in	37.0 lb	–	236-2654	–
233-8146	5	1/4 in- 2 1/2 in	3 3/4 in	5 1/4 in	50.0 lb	236-2655	236-2654	–
233-8147	6 ⁽¹⁾	1/4 in- 3 1/2 in	4 1/8 in	5 3/4 in	64.0 lb	236-2648	236-2654	–
Replacement Parts for Non Current Vises								
188-2143		–	–	–	–	–	4C-4400	–
188-2145		–	–	–	–	–	4C-4400	188-2167
188-2147		–	–	–	–	–	4C-4400	188-2170
4C-3741		–	–	–	–	–	4C-4400	–
4C-3742		–	–	–	–	–	4C-4400	4C-4392
4C-3743		–	–	–	–	–	4C-4400	4C-4393

Machinist Vises



Warranty: Manufacturer, Lifetime

- Stressed parts made of 60,000 PSI tensile strength ductile iron
- Straight line design guarantees a lifetime spindle and nut
- Precision slide bar is moveable, maintained with hardened steel key, insuring a .002 mm fit
- 360° slip proof swivel base—serrated teeth and double lockdowns
- Largest anvil of any machinists' vise

Part Number	Model	Jaw Width	Throat Depth	Max. Opening Width	Shipping Weight	Replacement Jaw Insert
4C-3751	350S	3 1/2 in	2 3/4 in	5 1/4 in	46.0 lb	–
4C-3752	400S	4 in	3 1/2 in	6 1/2 in	66.0 lb	–
4C-3753	450S	4 1/2 in	4 3/16 in	7 1/2 in	73.0 lb	4C-4394
4C-3754	500S	5 in	4 1/4 in	8 in	97.0 lb	4C-4399

¹ Warranty: Caterpillar, Lifetime

6 1/2" Tradesman Vice - 377-5722



Warranty: Manufacturer, Lifetime

- Built for maximum quality and performance
- Suited for shop use and on Dealer Service Trucks
- Sealed design protects moving parts from dirt, dust, and moisture
- Precision slide bar is fitted within .003" to minimize play
- Built-in anvil for forming and shaping materials
- Reversible jaw inserts provide either a non-marring or maximum grip
- Includes jaws for steel pipe

Jaw Width	Pipe Capacity	Throat Depth	Max. Opening Width	Shipping Weight
6 1/2 in	1/4 - 3 1/2 in	4 in	6 1/2 in	22kg (73 lb)

Part Number	Description
377-5722	6 1/2" Tradesman Vice

Combination Pipe and Bench Vises



Warranty: Manufacturer, Lifetime

- Stressed parts made of 60,000 PSI tensile strength ductile iron
- Replaceable hardened steel jaw inserts
- Hardened, replaceable steel pipe jaws
- Alloy steel slide bar

Part Number	Model	Jaw Width	Pipe Capacity	Throat Depth	Max. Opening Width	Shipping Weight	Replacement Jaw Insert
4C-3745	C-2	5 in	1/8 in- 4 1/2 in	5. 5/16 in	7 in	113.0 lb	4C-4395
4C-3746	C-3	6 in	3/8 in-6 in	6 5/8 in	9 in	209.0 lb	4C-4396

Model R — Rubber Face Magnefix Jaw Caps



Warranty: Manufacturer, Lifetime

- Aluminum alloy with synthetic rubber cover
- Jaw cap conforms to workpiece and grips firmly without slipping
- Designed to prevent cushioning during use
- Use in combination with Prism Jaw Caps to clamp taper pins or tapered workpieces
- Mar-free
- Jaw caps sold separately

Part Number	Jaw Width	Use with these Vises or any other with the same Jaw Width
4C-6833	6 in	4C-3746

Vises

Model P — Prism Magnefix Jaw Caps



Warranty: Manufacturer, Lifetime

- Jaw construction includes a 120° horizontal Vee-Groove, 3 vertical Vee-Grooves and a 90° groove for marking out and center punching
- Ideal for light tapping and thread cutting applications
- Capable of clamping a block of material in a vise to be utilized as a surface plate for light duty work
- Jaw caps sold separately

Part Number	Jaw Width	Use with these Vises or any other with the same Jaw Width
4C-6837	6 in ⁽²⁾	4C-3746

Jaw Caps



Warranty: Manufacturer, Lifetime

- Designed to avoid marring the surface of softer metals and to protect jaw faces
- Made to fit any size vise
- Polished faces and pliable copper extensions for a sure-grip fit on any make vise

Part Number	Description	Width
4C-3747	Jaw Cap	6 in
4C-3748	Jaw Cap	5 in
4C-3749	Jaw Cap	4 1/2 in
4C-3750	Jaw Cap	4 in

Holding Fixture

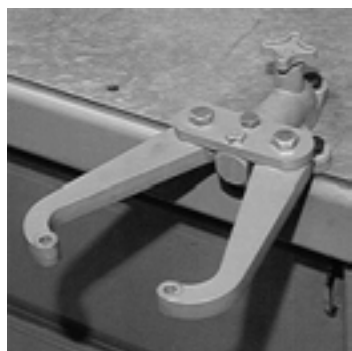

Warranty: Cat Standard Warranty, 6 Months

- Mounts on workbench
- Use to secure components during assembly and disassembly
- Capable of holding small transmissions, differentials, hydraulic pumps, water pumps and electrical components

Part Number	Capacity
2P-8338	250.0 lb

2 Warranty: Caterpillar, 6 Months

Yoke Pipe Vise



Warranty: Cat Standard Warranty, 6 Months

- Used to brace pipe for cutting and machining
- Used for pipe from 10 through 102 mm (1/8 through 3 1/2 in)

Part Number	Weight
127-1909	7.4 kg (16.23 lb)

Regular Duty, Standard Throat C-Clamps



Warranty: Manufacturer, Lifetime

- Recommended for regular-duty work not requiring unusual throat depth
- Drop forged from specially selected steels
- Light enough for production line use
- Equipped with Wilton Permapads[®] and lifetime lubricated spindles of through-hardened steel
- Finished in grey enamel

Part Number	Capacity	Throat Depth	Spindle Diameter	Minimum Proof Test	Weight
4C-3755	0 - 2 in	1 13/16	9/16	2.00	1 3/8 lb
4C-3756	0 - 3 in	1 15/16	9/16	3.00	1 43/64 lb
4C-3757	0 - 4 in	2 5/16	5/8	3.00	2 3/4 lb
4C-3758	0 - 6 in	2 15/16	5/8	4.00	3 3/4 lb
4C-3759	2 in - 8 in	3 7/16	3/4	5.00	7 lb
4C-3760	1 1/2 in - 10 in	3 3/4	3/4	6.00	8 3/8 lb
4C-3761	1 1/8 in - 12 in	3 7/8	3/4	8.00	12 lb

Battery Service Equipment

Cat Battery Tester

Warranty: Manufacturer's

4C-4911

- 1000 Amp Load Tester is ideal for battery distributors, high volume testing and fleet use.
- High resolution carbon pile assembly ensures maximum contact, reduces hot spots, prevents edge burning and provides smoother operation and longer life.
- High rpm fan cools for continuous battery testing

Part Number	Load	Ammeter	Voltmeter	Leads	Clamps	Limited Warranty	Weight	Shipping Dimensions (H x W x D)
4C-4911	1000A	0 - 1999 Amps (Digital)	0 - 19.99 V DC (Digital)	5 ft - 2 AWG	Vinyl insulated steel with flexi-spring and copper jaw	1 year	34 lb (15.4 kg)	16 in x 15 in x 15 in (.40 m x .38 m x .38m)

Multi-Battery Parallel Chargers

Warranty: Manufacturer, One Year

4C-4913
4C-9799



4C-4913

- Charges 1 - 10, 12 Volt Batteries, in parallel, in less than 24 hours
- 16 charge rates offer precise charging
- Alternate model 4C-4914 charges 1 - 36, 12 Volt batteries in parallel
- Can be mounted on wall or bench
- UL Listed; RoHS Compliant
- Patented multi-diode rectifier with deep reserve capacity

Additional accessories available:

- 4C-4917 Buss Bar ensures convenient way to hook up 10 batteries in parallel. Buss Bar includes 10 pairs of leads with insulated fiberglass backboard, with 300 Amp insulated safety clamps.
- 9U-5784 Charging Rack that stores up to 15 batteries

4C-4914



4C-4914

- Charges 1 - 36, 12 Volt Batteries, in parallel, in less than 24 hours
- Designed for 190 – 262 Vac 50/60Hz electrical environments
- Includes a patented multi-diode rectifier with a deep reserve capacity
- Circuit breaker protection and isolated transformer provides added safety
- Can be mounted on a wall or bench
- UL Listed

Additional accessories available:

- 4C-4917 Bus Bar ensures convenient way to hook up to 10 batteries in parallel. Bus Bar includes 10 pairs of DC Charging leads (48" long, 8.5 AWG with 300 Amp insulated clamps) and insulated fiberglass backboard
- 9U-5784 Charging Rack Battery charging rack stores up to 15 Batteries on three-shelf acid resistant, insulated rack

4C-9799

- Charges 1 – 10, 12 Volt Batteries, in parallel, in less than 24 hours
- Designed for 230 VAC 50/60Hz electrical environments
- Includes a patented multi-diode rectifier with a deep reserve capacity
- Circuit breaker protection and isolated transformer provides added safety
- Can be mounted on a wall or bench

Additional accessories available:

- 4C-4917 Bus Bar ensures convenient way to hook up to 10 batteries in parallel. Bus Bar includes 10 pairs of DC Charging leads (48" long, 8.5 AWG with 300 Amp insulated clamps) and insulated fiberglass backboard
- 9U-5784 Charging Rack Battery charging rack stores up to 15 Batteries on three-shelf acid resistant, insulated rack

Battery Service Equipment

Multi-Battery Parallel Chargers (Cont'd.)

Part Number	DC Output	AC Input	Battery Capacity	Charge Rates	Digital Voltmeter	Digital Ammeter	DC Leads	AC Cord	Weight	Shipping Dimensions (H x W x D)
4C-4913	30 Amps, 14.9 Volts	108-132/ VAC, 7.5A 60 Hz	Up to 10, 12 Volt Batteries	16	11 - 17 Volts	0 - 50 Amps	1.8 m (6 ft) 6.5 AWG	6.5 ft 16-3	18 kg (40 lb)	16 in x 19 in x 16 in
4C-4914	110 Amps, 15.5 Volts	190-262/ VAC, 13.8A 50/60Hz	Up to 36, 12 Volt Batteries	16	0 - 19.99 Volts (Digital)	0 - 199 Amps	1.5 m (5 ft) 1 AWG	No AC cord, must be hard wired	38 kg (83 lb)	26 in x 17 in x 14 in
4C-9799	30 Amps, 14.9 Volts ⁽¹⁾	210 - 250/ VAC, 4A, 50/ 60Hz	Up to 10, 12 Volt Batteries	16	11 - 17 Volts (Digital)	0 - 50 Amps	m (6.5 ft) 6 1/2 AWG	16A, 2m length (No Plug)	18 kg (40 lb)	16.5 in x 19 in x 16.5 in

Bus Bar Set - 4C-4917

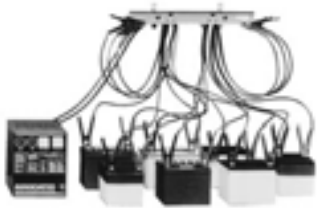

Warranty: Manufacturer, Mixed ⁽²⁾

- Bus Bar Set for parallel charging
- Ten Battery Capacity
- Use one or combine additional bars for additional capacity
- Insulated fiberglass backboard with 10 pairs of DC Charging leads, 4 AWG (36 in) long with 300 Amp insulated safety clamps
- Comes with (3 ft) 4 AWG cables to connect to charger or additional batteries
- Can be mounted on wall or bench
- Ensures convenient way to hook up to 10 batteries in parallel

Part Number	Capacity	Leads	Clamp	Material	Weight	Dimension
4C-4917	Connections for 10 Batteries	10 sets - 4 AWG, (36 in) long	300 Amp Insulated Safety	Insulated Fiberglass Backboard	11 kg (24 lb)	31.25 in x 15.25 in x 5.25 in

Battery Charging Rack



Warranty: Cat Standard Warranty, 6 Months

- Stores up to 15 batteries
- Three-shelf, acid resistant, insulated steel rack
- Includes 10 pairs of charging leads

Part Number	Description
9U-5784	Battery Charging Rack

¹ Warranty: Caterpillar, 6 Months

² One year on parts/labor, five years on transformer/rectifier

Heavy-Duty Commercial Fast Chargers



Warranty: Manufacturer, Mixed ⁽³⁾

4C-4920

- Highest performance fast chargers on the market
- 16 rates of charge and 75 amps
- 75 amps of continuous charge with 375 amps crank assist at 12 Volts
- Fan cooling prevents overheating enhancing unit's life span significantly
- UL and CSA listed with "Safe in Any Weather" Operation
- Patented "Stop / Go" Light
- Automatic reset AC and DC circuit breakers
- Automatic timer

4C-4921

- The highest performance fleet charger on the market
- 33% more engine start than the previous model
- 80 amp continuous charge with 400 amp crank assist at 12 Volts
- Fan cooling prevents overheating enhancing unit's life span significantly
- 500 Amp, fully insulated, "Flexi-Spring" clamps
- UL and CSA listed with "Safe in Any Weather" operation
- Patented "Stop / Go" Light
- Automatic reset AC and DC circuit breakers
- Automatic timer



4C-4910

- Charges all standard & maintenance free 6/12/24 V batteries
- High Output 220VAC Charger
- Cranking assist rating of 325 amps at 6 Volts
- Fan cooling mechanism prevents overheating enhancing the unit's life span significantly
- Certified for outdoor use, safe in any weather
- Cautions against incorrect polarity with patented "stop-go-light" technology
- CE Approved

Part Number	Electrical Requirements	Battery Voltage	UL Continuous Rating	Weight	UL Cranking Assist Rate	MFGS Boost Rating	AC Cord	DC Leads	Clamp Rating	Shipping Dimension (H x W x D)	Timer
4C-4920 Specifications											
4C-4920	120 VAC, 14.8A, 50 Hz	6/12 Volt	100/75 Amp	25 kg (55 lb)	375 Amp	625 Amp	3m (10 ft) 14 - 3	2.4 m (8 ft) 4 AWG	500 Amp	26 in x 16 in x 14 in	-
4C-4921 Specifications											
4C-4921	120 VAC, 15A, 60 Hz	6/12/18/24 Volt		31 kg (68 lb)	400 Amp	725 Amp	3m (10 ft) 14 - 3	2.4 m (8 ft) 4 AWG	500 Amp	26 in x 16 in x 14 in	-
4C-4910 Specifications											
4C-4910 ⁽⁴⁾	230 VAC; 50/60 Hz	6/12/24 Volt	90/75/55 Amp	34 kg (75 lb)	325/270/180 Amp	300/500/700 Amp	2.4 m (7.9 ft) 16A Euro plug	3 m (9.8 ft) 4 AWG	500 Amp	26 in x 16.5 in x 14 in	90 minute auto

3 One year on parts/labor, five years on transformer/rectifier

4 Warranty: Caterpillar, Six Months

Battery Service Equipment

Portable Chargers



Warranty: Manufacturer, Mixed ⁽⁵⁾

4C-4924

- Chargers all standard and maintenance free 6/12 Volt Batteries with 4 charging positions
- Fully portable
- Fan cooling mechanism prevents overheating enhancing unit's life span significantly
- Certified for outdoor use in any weather
- Cautions against incorrect polarity with patented "stop-go-light" technology
- 500 Amp clamps are covered with vinyl insulation; will not arc or spark

4C-4925

- Charges all standard maintenance free 6 and 12 volt batteries
- Four charging positions
- Fan cooled to extend units life span
- UL, cUL certified for indoor and outdoor use

200-6319

- Analyzes battery condition and automatically selects proper charging technique
- Voltage controlled charging
- Suitable for flooded batteries including GEL and AGM
- Utilizes three color LEDS to monitor charging status
- Program for deep discharge recovery of flooded batteries
- Capable of charging both small and large batteries
- Switch for selecting battery type
- Maintains battery charge, can be left connected to battery

Part Number	Battery Voltage	AC Input	Continu-ous Rating	Amps Boost Rating	Cranking Assist Rating	Timer	Weight	AC Cord	DC Leads	Clamp Rating	Dimensions
4C-4924	6/12 Volt	120VAC, 12.9A, 60Hz	70/60 Amp	420 Amp	230 Amp	90 min Auto	17 kg (38 lb)	(6 1/2 ft) 2 m	7 ft 4/AWG	500 Amp	—
4C-4925	6/12 Volt	120VAC, 60Hz	40/10 Amp	300 Amp	200 Amp	—	14 kg (31 lb)	(6 ft) 1.8 m	6 ft 6/AWG	200 Amp	—
200-6319	12 Volt	120VAC, 2.2A, 60Hz	10 Amp	—	—	—	5 kg (11 lb)	(6 ft) 1.8 m	6 ft 16/AWG	50 Amp	10 in x 9 in x 9 in

⁵ Part number 200-6319: One Year; Part number 4C-4924: One Year on parts/labor, five years on transformer/rectifier

Extra Heavy-Duty Plug-In Starting System



Warranty: Cat Standard Warranty, 6 Months

- More truck starting power than 8hp gas starter
- Extra heavy duty plug-in starting system ideal for volume car starting in extremely cold climates
- Heavier 1 AWG cable has half the voltage drop as Model 4C-4929 (6139)
- Anti-spark delay timer protection for safety during hook-up
- Circuit breaker protection
- Polarity protection
- 30 foot of tangle-free cables
- Stainless steel receptacle mounts onto a truck bumper and connects directly to a battery
- Reaches stalled vehicles from front, back, or side
- Solid copper jaw, with patented insulated clamps with “flexi-spring” cable guard
- Patented “stop-go safety light”

Part Number	Description	Total Length	Vehicle Connection Length	Gauge	Cir. Mil. Copper, Jacket	Amp Clamp	Side Terminal Adapters	SAE Rating	Weight	Shipping Dimensions
4C-4930	Extra Heavy-Duty Plug-In Starting System	30 ft	5 ft	1 AWG	83,600 T-94	800 A	No	Super Heavy-Duty	26 lb	9 in x 12 in x 12 in
Service Part										
4C-9917	Power Socket with Battery Cable	–	–	–	–	–	–	–	–	–

Heavy-Duty Plug-In Starting System



Warranty: Cat Standard Warranty, 6 Months

- Stainless Steel receptacle mounts onto a truck bumper and connects directly to a battery
- Reaches stalled vehicles from front, back or side
- Polarized LEXAN plug won't break in coldest weather
- Solid copper jaw, with patented insulated clamps with “flexi-spring” cable guard
- Patented “stop-go safety light”
- 30 ft of tangle-free cables
- For the flush mount version, combine with 4C-4931 (6125)

Part Number	Description	Total Length	Vehicle Connection Length	Gauge	Cir. Mil. Copper, Jacket	Amp Clamp	Side Terminal Adapters	SAE Rating	Weight	Shipping Dimensions
4C-4929	Heavy-Duty Plug-In Starting System	30 ft	5 ft	4 AWG	41,300 T-94	500 A	Yes	Heavy-Duty	17 lb	6 in x 12 in x 12 in
Service Parts										
4C-4943	Power Socket with battery cable	–	–	–	–	–	–	–	–	–

Battery Service Equipment

Heavy-Duty Plug-In Starting System (Cont'd.)

Part Number	Description	Total Length	Vehicle Connection Length	Gauge	Cir. Mil. Copper, Jacket	Amp Clamp	Side Terminal Adapters	SAE Rating	Weight	Shipping Dimensions
4C-4944	Plug-in Cable (includes clamps)	-	-	-	-	-	-	-	-	-
4C-4946	Polarized Lexan® Plug, .45 kg (1 lb)	-	-	-	-	-	-	-	-	-

Flush Mount Power Socket



Warranty: Cat Standard Warranty, 6 Months

- Alternative to cabinet style socket — stainless steel plate mounts flush on service vehicle
- For a complete starting system, order 4C-4931 and 4C-4944 Plug-In Cables

Part Number	Description
4C-4931	Flush Mount Power Socket

Booster Cables



Warranty: Cat Standard Warranty, 6 Months

- Professional quality
- Ensure quick and efficient connections
- Designed for convenience and safety
- Replacement clamps available

Part Number	Length	Gauge	Gauge (circular mil)	Jacket	Clamp Rating	Side Terminal Adapters	Approx. Individual Weight
Heavy Duty and Super Heavy Duty Cables							
4C-4934 ⁽⁶⁾	4 m (12 ft)	5 AWG	32,900	T-94 ⁽⁷⁾	500 A	Yes	3.6 kg (7.94 lb)
4C-4938	5 m (15 ft)	1/0 AWG	106,400	T-94 ⁽⁷⁾	800 A	No	7.3 kg (16.09 lb)
Booster Cables							
300-5899	6 m (20 ft)	2 AWG	62,450	T-94	600A	No	6.4 kg (14.11 lb)
4C-4933	4 m (12 ft)	4 AWG	37,360	T-94 ⁽⁷⁾	500E	No	2.7 kg (5.95 lb)
4C-4935	5 m (16 ft)	4 AWG	37,360	T-94 ⁽⁷⁾	500E	No	3.6 kg (7.94 lb)
4C-4936	6 m (20 ft)	4 AWG	37,360	T-94 ⁽⁷⁾	500E	No	4.1 kg (9.04 lb)

6 Equipped with stop/go light - red L.E.D.s warn operator if polarity is reversed

7 T-94: flexible to 4° C (-40° F)

Battery Service Equipment

Replacement Clamps



Warranty: Cat Standard Warranty, 6 Months

- Designed to grip securely to side terminal and/or post terminal batteries for maximum current carrying capacity
- Color coded (Red/Black) for safety and visual appeal

Part Number	Description	Clamp Rating	Jaws	Insulation	Weight/Master
4C-4940	Replacement clamp for use with 3, 4, and 6 ga cable	500A	Copper	Bonded Vinyl	4 kg (8.82 lb)
4C-4942	Batteries and Battery Chargers	600A	Heavy Gauge Copper	Bonded Vinyl	4.5 kg (9.92 lb)

Battery Post Set

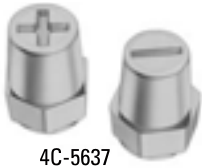

4C-5637



4C-5638

Warranty: Cat Standard Warranty, 6 Months

Part Number	Description
4C-5637	10 mm (3/8 in) Female for Stud Type Batteries
4C-5638	10 mm (3/8 in) Male for Side Terminal Batteries

Cables



Warranty: Cat Standard Warranty, 6 Months

- Polarized plug on both ends
- Mates with either 4C-9917 or 4C-4943 Power Socket

Part Number	Description	Mates with
4C-9801	3.66 m (12 ft) 4 AWG	4C-4943 Power Socket
4C-9802	3.66 m (12 ft) 1 AWG	4C-9917 Power Socket

Battery Service Equipment

Battery Cable Repair Kit - 6V-3025



Warranty: Cat Standard Warranty, 6 Months

- Fabricate or repair 8 through 4/0 gauge electrical cables
- Install splices or terminals
- Crimping tool comes with multiple dies for various cable sizes (AWG No. 8, 6, 4, 2, 1/0, 2/0, 3/0, 4/0)
- Cable Cutter - can cut up to 500 MCM copper or aluminum cable

Reference

Special Instruction SMHS7677, Use of Battery Cable Repair Kit

Part Number	Description	Qty.
6V-3025	Battery Cable Repair Kit	—
Battery Cable Repair Kit includes:		
6V-3017	00 Butt Splice	4
6V-3018	0 Butt Splice	3
6V-3019	000 Butt Splice	3
6V-3020	0000 Butt Splice	2
6V-3021	Crimping Tool	—
6V-3022	Cable Cutter	—
6V-3023	Box	—
Replacement Dies for 6V-3021		
1U-6659	Left-Hand	—
1U-6660	Right-Hand	—

Lighting and Electrical Products — Flashlights and Batteries

Mini-Maglite Flashlight



Warranty: Manufacturer, Lifetime

- For people on-the-go, can be carried on the hip in its own nylon belt holster
- Includes two AA batteries

Part Number	Description	Length
9U-7231	Mini-Maglite Flashlite	5 3/4 inches

Heavy-Duty Professional Flashlights



Warranty: Manufacturer, Lifetime

- High quality
- Designed and manufactured in the U.S.A.
- Precision machined, high strength aluminum exterior components
- Anodized internally and externally for optimum corrosion resistance
- Water resistant O-ring seals throughout protecting an internal self-actuating switch
- Hi-impact, scratch resistant Lexan® lens
- Fast action Linear-Focusing™ flood-to-spot beam with a twist of the wrist
- Extra long lamp life, equivalent of 3 or 4 sets of batteries
- Approximately 5 to 6 hours operating time per set of batteries
- Ambient candle mode for hands free operation
- Spare lamp in tail cap
- Includes two AA size alkaline batteries (4C-9463), available worldwide
- All flashlights have Cat logo

Item	Part Number	Description	Length	Batteries
1	1U-7321	Flashlight	254 mm (10 in) long	2 D cell batteries (replacement lamp 4C-9464)
2	1U-7322	Flashlight	310 mm (12 3/16 in) long	3 D cell batteries (replacement lamp 4C-9465)
3	4C-9442	Flashlight	375 mm (14 3/4 in) long	4 D cell batteries (replacement lamp 4C-9466)
Accessories (Warranty: Six Months)				
4	4C-9448 ⁽¹⁾	Mounting Clamp kit for all D cell flashlights, 2 clamps and screws	–	–

Heavy-Duty Professional Rechargeable Flashlight Accessories

Warranty: Cat Standard Warranty, 6 Months

Part Number	Description
4C-9470	Halogen Replacement Bulb

¹ Warranty: Caterpillar, Six Months

Lighting and Electrical Products — Flashlights and Batteries

Heavy-Duty Flashlights



Warranty: Cat Standard Warranty, 6 Months

- Water-resistant, made of high impact plastic, with corrosion resistant contact parts and a belt ring to prevent loss
- Battery barrier protects bulb and head contacts from impact force
- Comes with spare bulb
- Batteries not included

Part Number	Size	Batteries	Switch	Comes with
1U-7319	210 mm (8 1/4 in) long	2 D cell batteries	—	—

Continuity Tester/Flashlight



Warranty: Cat Standard Warranty, 6 Months

- Made of high impact plastic
- Can be used as a flashlight or continuity tester
- Yellow with black cap
- Uses 2 D cell batteries (not included)
- 1.82 m (72 in) length continuity wires shipped inside flashlight
- Magnet allows your hands to be free for testing

Part Number	Description	Length
1U-7318	Continuity Tester / Flashlight	210 mm (8 1/4 in)
Service Part		
1U-9532	D-Cell Alkaline Battery	—

Lighting and Electrical Products — Flashlights and Batteries

Inspection Light - 141-1655



Warranty: Manufacturer, Lifetime

- Lightweight, super compact light source
- White beam to penetrate smoke, fog and water
- Water-tight to 609.6 m (2000 ft)
- Shock proof, corrosion proof
- Economical, 30-hour long life lamp module
- Handy shirt clip
- Includes two AA batteries
- Includes 90° light bender

Part Number	Description
141-1655	Inspection Light
Service Part	
4C-6741	Lamp Module (Qty. 12) ⁽²⁾

Industrial Batteries



Warranty: Cat Standard Warranty, 6 Months

Alkaline

- Top-of-the-line for maximum service life
- Best for use in high-drain, continuous use situations

Heavy-Duty

- Ideally suited for normal industrial use

Part Number	Description	Voltage	Package Quantity
1U-9531	C-Cell Alkaline Battery	1.5	72
1U-9532	D-Cell Alkaline Battery	1.5	72
1U-9533	AA Alkaline Battery , non-rechargeable, package qty 96 (5 required to power Indicator III)	1.5	96
1U-9534	Battery - 9V Size (not shown)	9	72
1U-9535	AAA-Cell Alkaline Battery	1.5	96
1U-9536	C-Cell Heavy-Duty Battery	1.5	72
1U-9537	D-Cell Heavy-Duty Battery	1.5	72
1U-9538	AA-Cell Heavy-Duty Battery	1.5	96
1U-9539	9 Volt Heavy-Duty Battery	9	72
245-3224	AAAA-Cell Alkaline Battery ⁽³⁾	1.5	6

² Warranty: Manufacturer's, Lifetime

³ Warranty: Manufacturer, 120 Day

Lighting and Electrical Products — Flashlights and Batteries

Pen Light



Warranty: Manufacturer, 120 Day

European Union Compliant, CE marked

- Made from tempered aircraft aluminum
- 100,000 hour lifetime, hi-intensity light emitting diode (LED) bulb
- Batteries last up to 60 hours
- Includes 3 AAAA batteries
- Handy shirt clip
- Push end of pen light to momentarily illuminate or twist end clockwise for constant "on"
- Waterproof

Part Number	Description
238-8244	Pen Light, White LED
269-3123	Pen Light, Blue LED
Replacement Batteries	
245-3224 ⁽⁴⁾	AAAA-Cell Alkaline Battery

Hi-Energy Battery Charger



Warranty: Cat Standard Warranty, 6 Months

- Charges one to four AA or AAA NiMH batteries in 30 minutes (up to 1850 mAh)
- "Smart Charger" — individually monitors cell condition and terminates charging current when charged
- Includes "Trickle Charge" — low rate charge to retain charge level that would otherwise be lost due to self-discharge and storage
- Illuminated LED monitoring lights
- Ideal for high-drain applications
- DC input 11-16V, 3A (AC adapter included)
- Should not be used to charge any other battery type other than NiMH
- Only charges one size of battery at a time (do not mix AA and AAA in same charge)
- Includes 4 AA rechargeable batteries

Part Number	Charge Capacity	AA Charge Capacity	AAA Charge Capacity	Charging Current	Trickle Charge	Charging Time	AC Input Rating
261-0022	Charge capacity	up to 2100 mAh	up to 750 mAh	Charging current	Trickle charge	30 minutes (up to 1850 mAh)	110 volts (110 volts)

⁴ Warranty: Manufacturer, 120 Day

Lighting and Electrical Products — Flashlights and Batteries

AA Rechargeable Batteries



Warranty: Cat Standard Warranty, 6 Months

- Nickel-metal hydride (NiMH) batteries
- Ideal for the most advanced high-drain devices — digital cameras, personal digital assistants (PDA's), voltmeters, flashlights, borescopes, analyzers, and many other diagnostic service tools
- High-capacity cells provide exceptional power per charge and up to 1000 recharges
- Recharge to full power at any time
- New batteries should be charged for 24 hours before first use
- Good economic and environmental choice

Part Number	Size	Designation	Voltage	Average Capacity	Qty.
261-0024	AA, 1.2 Volt	ANSI-1.2H2	1.2 volts (1.20 volts)	2300 mAh	4 per package

Lantern Battery



Warranty: Cat Standard Warranty, 6 Months

- Offers dependable high performance for portable lighting uses
- Recommended for all industrial lanterns

Part Number	Description	Package Quantity
1U-9547	Lantern Battery, Spring Terminal, 6 Volt	12

Lighting and Electrical Products — Work Lights and Extension Cords

Portable Fluorescent Work Lights

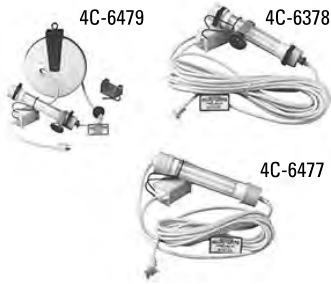

Warranty: Manufacturer, One Year

- 13 Watt fluorescent lamp is equivalent in light output to a 60 Watt incandescent, but four times more efficient and will last up to 10 times longer (10,000 hours)
- Built with the Saf-T-Lite design concept which places light and all electrical components inside a closed chamber for user safety
- Protected on-off switch can be operated by depressing domed end of the light
- Entire light double insulated for user safety
- Oil resistant power cord , UL listed and meets OSHA standards
- Durable and shatter resistant butyrate outer tube gives long life
- 4C-6478 and 4C-6479 include magnetic mounts and vapor clips

Part Number	Description	Length	Cord Type	Voltage/Watt	Standard Color
4C-6477	Portable Florescent Work Light	7.62 m (25 ft) Cord	SJTO 18/2	110V/13 Watt	Yellow
4C-6478	Portable Florescent Work Light	15.24 m (50 ft) Cord	SJTO 18/2	110V/13 Watt	Yellow
4C-6479	Portable Florescent Work Light	12.19 m (40 ft) Reel	SJT 18/2	110V/13 Watt	Yellow
9U-7203	Portable Florescent Work Light	9.5 m (30 ft) Cord	SJTOW-A 18/2	12V/13 Watt	Yellow
Service Parts for 9U-7203					
9U-6712	Replacement Lamp, 12V, 13 Watt	–	–	–	–

Accessories for Light Assemblies



Warranty: Manufacturer, One Year

Part Number	Description	Material
9U-6009	Fluorescent Lamp, 110V/13 Watt	Twin Tube, cool white light emission
9U-6010	Magnetic Mount 26.3 kg (58 lb) pull	Nickel plated magnet

Fluorescent Light Kit



Warranty: Manufacturer, One Year

- 110V kit which includes 13 Watt lamp, outer tube, switch assembly and installation instructions
- Install onto any Saf-T-Lite reel or cordset which was originally equipped with a 110V/13 Watt "Stubby" light head, such as 4C-6477, 4C-6478 or 4C-6479

Part Number	Description
9U-6710	Fluorescent Light Kit
Replacement Parts	
9U-6009	Fluorescent Lamp, 110V/13 Watt
9U-6708	Clear Outer Tube

Lighting and Electrical Products — Work Lights and Extension Cords

Ratchet Light



Warranty: Cat Standard Warranty, 6 Months

- 120 Volt/60 Hz light made from yellow, unbreakable aerospace plastic with a 10 amp tool-tap-plug
- 10,000 hour life, 13 Watt rough-service fluorescent bulb delivers output of a 60 Watt incandescent bulb
- STOW type cord — used for heavy duty service and with oil-resistant, thermo-plastic jacket, is weather resistant for outdoor use
- Two year warranty on workmanship and material defects (not including bulb)
- Handy magnetic base so you can position the light where you need it
- UL Approved

Part Number	Description	Cord Type
179-7043	Ratchet Light	STOW Type Cord - 7.62 m (25 ft) long, made from 16/3 wire

Angle Light Reel



Warranty: Cat Standard Warranty, 6 Months

- 120 Volt/60 Hz light (yellow) includes shatter/scratch resistant lens, 10 amp tool-tap-plug, and velcro magnet
- 10,000 hour life, 13 Watt rough service fluorescent bulb delivers output of a 60 Watt incandescent bulb
- Black reel made from shatter resistant ABS plastic
- STOW type cord — used for heavy duty service and with oil-resistant, thermo-plastic jacket, is weather resistant for outdoor use
- Two year warranty on workmanship and material defects (not including bulb)
- UL Approved

Part Number	Description	Cord Type
179-7046	Angle Light Reel	STOW Type Cord - 15.2 m (50 ft) long, made from 16/3 wire
Parts		
179-7048	Lens	—
179-7049	Bulb	—
179-7050	Velcro Magnet	—

Lighting and Electrical Products — Work Lights and Extension Cords

Angle Light



Warranty: Cat Standard Warranty, 6 Months

- 120 Volt/60 Hz light includes shatter/scratch resistant lens, 10 amp tool-tap-plug, and velcro magnet
- 10,000 hour life, 13 Watt rough service fluorescent bulb delivers output of a 60 Watt incandescent bulb
- Yellow case is made from unbreakable aerospace plastic
- STOW type cord — Used for heavy duty service and with oil-resistant, thermo-plastic jacket, is weather resistant for outdoor use
- Two year warranty on workmanship and material defects (not including bulb)
- UL Approved

Part Number	Description	Cord Type
179-7047	Angle Light	STOW Type Cord - 7.62 m (25 ft) long, made from 16/3 wire
Parts		
179-7048	Lens	—
179-7049	Bulb	—
179-7050	Velcro Magnet	—

Triple-Tap Extension Cord



Warranty: Cat Standard Warranty, 6 Months

- 120 Volt/60 Hz reel extension cord is 15.2 m (50 ft) long, made from 16/3 wire with a built-in 10 amp circuit breaker
- Case is made from shatter resistant ABS plastic
- Two year warranty on workmanship and material defects
- UL Approved

Part Number	Description
179-7053	Triple-Tap Extension Cord

Lighting and Electrical Products — Work Lights and Extension Cords

Light Rover



Warranty: Cat Standard Warranty, 6 Months

- 120 Volt/60 Hz light has large, shock-absorbent, easy-grip end caps and a scratch/shatter resistant lens
- 10,000 hour life, 13 Watt rough service fluorescent bulb delivers output of a 60 Watt incandescent bulb
- Unique plug base converts any extension cord into a light
- Two year warranty on workmanship and material defects (not including bulb)
- UL Approved

Part Number	Description
179-7054	Light Rover
Parts	
179-7049	Bulb

Work Light



Warranty: Cat Standard Warranty, 6 Months

- 120 Volt/60 Hz light includes large, shock-absorbent, easy-grip end caps, and a scratch/shatter resistant lens
- 15 Watt rough service fluorescent bulb delivers output of an 80 Watt incandescent bulb
- STOW type cord — Used for heavy duty service and with oil-resistant, thermoplastic jacket, is weather resistant for outdoor use
- Two year warranty on workmanship and material defects (not including bulb)
- UL Approved

Part Number	Description	Cord Type
179-7056	Work Light	STOW type Cord - Cord is 7.62 m (25 ft) long, made from 18/2 wire
179-7058	Bulb	—

Lighting and Electrical Products — Work Lights and Extension Cords

Electrical Cord Definitions

Abbreviations	
U.L.	Underwriters Laboratories
C.U.L.	Canadian Underwriters Laboratories
O.S.H.A.	Office of Safety and Health Administration
NEMA	National Electrical Manufacturers Association
Cord Designation by Letter	
"S"	Hard surface, flexible cord, general use
"J"	300 Volt cord or smaller
"E"	Elastic synthetic rubber, good low temp cord
"W"	Watertight cord
"O"	Oil resistant
"A"	Low-temperature rated
"T"	Thermo-grade plastic

Heavy-duty Contractor and Industrial Application Extension Cords



Warranty: Cat Standard Warranty, 6 Months

- Designed for heavy-duty use by contractors and industrial applications
- Outer jacket protects against rough handling and extreme weather conditions
- Provides superior resistance to sunlight, ozone, cracking, oils chemicals, and moisture
- All cords have Cat logo printed on cord
- All extension cords are UL (Underwriters Laboratory) listed and meet OSHA (Office of Safety and Health Administration) requirements
- All plugs and outlets are NEMA (National Electrical Manufacturers Association) designated — 5-15P plug and 5-15R outlet

Part Number	Length	Material	Outlet	Wire Size	Rating ⁽¹⁾	Voltage Rating	Operating Temperature
241-8522	25.00 ft	all-weather vinyl	single	12 gauge, 3 conductor	SJTOW	300 volts	-35 to 60°C (-31 to 140°F)
241-8529	50.00 ft	all-weather vinyl	single	12 gauge, 3 conductor	SJTOW	300 volts	-35 to 60°C (-31 to 140°F)
241-8530	100.00 ft	all-weather vinyl	single	12 gauge, 3 conductor	SJTOW	300 volts	-35 to 60°C (-31 to 140°F)
243-1874	25.00 ft	all-weather vinyl	triple	12 gauge, 3 conductor	SJTOW	300 volts	-35 to 60°C (-31 to 140°F)
243-1875	50.00 ft	all-weather vinyl	triple	12 gauge, 3 conductor	SJTOW	300 volts	-35 to 60°C (-31 to 140°F)
243-1876	100.00 ft	all-weather vinyl	triple	12 gauge, 3 conductor	SJTOW	300 volts	-35 to 60°C (-31 to 140°F)
243-1877	25.00 ft	all-weather vinyl	triple	10 gauge, 3 conductor	SJTOW	300 volts	-35 to 60°C (-31 to 140°F)
243-1878	50.00 ft	all-weather vinyl	triple	10 gauge, 3 conductor	SJTOW	300 volts	-35 to 60°C (-31 to 140°F)
243-1879	100.00 ft	all-weather vinyl	triple	10 gauge, 3 conductor	SJTOW	300 volts	-35 to 60°C (-31 to 140°F)

1 (S) Hard Surface, Flexible Cord, General Use; (J) 300 Volt cord or smaller; (W) Watertight Cord; (O) Oil Resistant; (T) Thermo Grade Plastic

Lighting and Electrical Products — Work Lights and Extension Cords

Heavy-Duty Connectors and Plugs (20-30 Amps) with Insulating Cord Grip



Warranty: Manufacturer's

- For use in construction sites, industrial, dusty, and damp environments
- For use with tools, motors, grinding machines, high pressure washers, outdoor lighting
- UL and CSA listed

Part Number	Type	Description	Cord Diameter
9U-6374	20 Amp, 125/250V Connector	Yellow High Impact, with Insulating Cord Grip	14.27 - 26.97 mm (.562 in - 1.062 in)
9U-6378	30 Amp, 125V Connector	Yellow High Impact, with Insulating Cord Grip	15.875 - 28.575 mm (.625 in - 1.125 in)
9U-6379	30 Amp, 125V Plug	Yellow High Impact, with Insulating Cord Grip	15.875 - 28.575 mm (.625 in - 1.125 in)

Lighting and Electrical Products — Miscellaneous

Rubber Splicing Compound



Warranty: Cat Standard Warranty, 6 Months

- Linerless rubber tape
- Use for insulating and sealing on electrical cable installation and repair

Part Number	Description	Size	Qty.
4C-6393	Rubber Splicing Compound	19 mm (3/4 in) wide x 0.8 mm (0.030 in) thick x 4.6 m (15 ft) long rolls	1 roll per package

Wire Marker Tape Dispenser



Warranty: Cat Standard Warranty, 6 Months

- Provides a fast, convenient system for marking wire or cable
- Helps eliminate errors in the disassembly and assembly of hydraulic lines, wiring harness, generator sets and panels
- Ten refillable compartments with numbers from 0 to 9 let you choose the exact number/letter combinations needed
- Easy to use, easy to carry; convenient rolls — easy cutoff, no waste
- Tapes are an epoxy film with an acrylic adhesive
- Highly resistant to oils and solvents

Part Number	Description
6V-7939	Wire Marker Tape Dispenser
Marker Tape Replacement Rolls (10 rolls per box)	
8T-5209	Tape No. 0
8T-5211	Tape No. 1
8T-5212	Tape No. 2
8T-5213	Tape No. 3
8T-5214	Tape No. 4
8T-5215	Tape No. 5
8T-5216	Tape No. 6
8T-5217	Tape No. 7
8T-5218	Tape No. 8
8T-5219	Tape No. 9

Lighting and Electrical Products — Miscellaneous

Crimping Tools



Warranty: Cat Standard Warranty, 6 Months

- For insulated and uninsulated ferrules

Part Number	Wire Gauge
139-2788	24-12 AWG
139-2789	10-6 AWG
386-5102	28-24, 24-20, 18-16

Heat Shrinking Tubing



Warranty: Cat Standard Warranty, 6 Months

- Made from polyolefin
- Effectively resists abrasion, scoring, cut-through, and the effects of long term aging
- Easy to install
- Use on inline electrical splices to provide mechanical protection as well as corrosion and moisture seal

Part Number	Expanded I.D.	Recovered I.D.	Recovered Length	Package Quantity
4C-6387	10 mm (.400 in)	3.8 mm (0.15 in)	152 mm (6 in)	25
4C-6388	20 mm (.800 in)	5.0 mm (0.20 in)	152 mm (6 in)	5
4C-6389	28 mm (1.10)	9.4 mm (0.37 in)	229 mm (9 in)	5
4C-6390	388 mm (1.50 in)	12.7 mm (0.50 in)	229 mm (9 in)	5
4C-6391	51 mm (2.00 in)	16.5 mm (0.65 in)	229 mm (9 in)	1

Heat Shrinking Butt Connector



Warranty: Cat Standard Warranty, 6 Months

- One piece, pre-insulated
- Use on inline electrical splice where moisture and corrosion are a concern
- Easy application

Part Number	Wire	Barrel Length (L)	I.D.	Color	Package Quantity
4C-6394	#22 to 18 AWG	.28	.062	Red	100
4C-6395	#16 to 14 AWG	.30	.095	Blue	100
4C-6396	#12 to 10 AWG	.38	.142	Yellow	100

Lighting and Electrical Products — Miscellaneous

Cold Shrink Insulators



Warranty: Cat Standard Warranty, 6 Months

- Rubber insulators can be used on cable to insulate as well as to protect from moisture and corrosion while remaining flexible
- Resists fungus, acids and alkalies, ozone and ultra-violet light
- Easy to install (no flame/torch needed) — unwind the expander core by pulling the insulator and tubing will shrink to cable diameter
- When shrunk, connection is water resistant
- Very portable since no heat source is required

Part Number	Minimum Diameter	Tube Max.	Relaxed Package Length	Qty.
4C-6382	2.5 mm (0.10 in)	21.6 mm (0.85 in)	203 mm (8 in)	1
4C-6383	10.6 mm (0.42 in)	21.6 mm (0.85 in)	203 mm (8 in)	1
4C-6384	13 mm (0.51 in)	25.4 mm (1 in)	229 mm (9 in)	1
4C-6385	17.5 mm (0.69 in)	33 mm (1.30 in)	304.8 mm (12 in)	1
4C-6386	24.1 mm (0.95 in)	48.3 mm (1.90 in)	304.8 mm (12 in)	1

Wedge Removal Tool

Warranty: Cat Standard Warranty, 6 Months

- Use to remove wedges from DT series Deutsch connectors

Part Number	Description
147-6456	Wedge Removal Tool (included in kit)

Straight Blade Plugs and Connectors



Warranty: Manufacturer's

- For use in construction sites, industrial, dusty, and damp environments
- For use with tools, motors, grinding machines, high pressure washers, outdoor lighting
- UL and CSA listed

Part Number	Type	Description
9U-6362	15 Amp, 125V AC Connector	2 Pole, 3 Wire, NEMA 5-15P
9U-6363	15 Amp, 125V AC Plug	2 Pole, 3 Wire, NEMA 5-15P
9U-6364	15 Amp, 250V AC Connector	2 Pole, 3 Wire, NEMA 6-15P
9U-6366	20 Amp, 125V AC Connector	2 Pole, 3 Wire, NEMA 5-20P
9U-6368	20 Amp, 250V AC Connector	2 Pole, 3 Wire, NEMA 6-20P
9U-6369	20 Amp, 250V AC Plug	2 Pole, 3 Wire, NEMA 6-20P

Lighting and Electrical Products — Miscellaneous

Sure Seal Series Field Service Kit



Warranty: Cat Standard Warranty, 6 Months

- Make or repair custom connectors
- Easy to assemble
- Forms a water, chemical, and grime resistant seal
- Wide variety of circuit configurations
- Tested from -40°C to 105°C (-40°F to 221°F)
- Designed for 14 to 18 gauge wire carrying up to 15 Amps

Reference

Special Instruction SMHS7531, Use of Sure Seal Repair Kit

Part Number	Qty.	Description	Size
6V-3000	1	Sure Seal Field Service Kit	—
Sure Seal Field Service Kit Consists of			
6V-3001	1	Sure Seal Crimping Tool	—
6V-3007	1	Divided Box w/ Hinged Lid	
6V-3008	1	Insertion Tool	—
7N-7779	100	Socket Connector	14 - 18 AWG
7N-7780	100	Pin Connector	14 - 18 AWG
9G-3695	50	Sealing Plug	
1 Connector			
7N-7777	3	Socket Housing	—
7N-7778	3	Plug Housing	—
2 Connector			
7N-9737	3	Plug Housing	—
7N-9738	3	Socket Housing	—
3 Connector			
7N-7781	3	Socket Housing	—
7N-7782	3	Plug Housing	—
4 Connector			
7N-8204	3	Socket Housing	—
7N-8205	3	Plug Housing	—
5 Connector			
9G-3672	1	Plug Housing	—
9G-3678	1	Socket Housing	—
6 Connector			
9G-3671	1	Plug Housing	—
9G-3677	1	Socket Housing	—
7 Connector			
9G-3670	—	Plug Housing	—
9G-3676	1	Socket Housing	—
8 Connector			
9G-3669	1	Plug Housing	—

Lighting and Electrical Products — Miscellaneous

Sure Seal Series Field Service Kit (Cont'd.)

Part Number	Qty.	Description	Size
9G-3675	1	Socket Housing	—
9 Connector			
9G-3668	1	Plug Housing	—
9G-3674	1	Socket Housing	—
10 Connector			
9G-3667	1	Plug Housing	—
9G-3673	1	Socket Housing	—

Personal Protective Equipment — Gloves

Utility Glove



Warranty: Cat Standard Warranty, 6 Months

- Black
- Synthetic Leather Palm
- Synthetic Leather Fingertips
- Spandex Back
- Lighter and More Durable than Leather
- More Breathable than Leather
- Reinforced Thumb
- Adjustable Wrist Strap
- CE marked, EN388: 2211, AS/NZS2161.2

Part Number	Size
377-5750	Medium
377-5751	Large
377-5752	Extra Large

Utility Gloves



Warranty: Cat Standard Warranty, 6 Months

- Help protect from heat, cold, nicks, cuts, and bruises
- Split-palm design ensures long life in high-wear areas
- Hidden seam design eliminates snagging
- Tough spandex top material resists snags
- Snug, comfort fit assures greater dexterity
- NOT flame-proof or fire retardant
- Machine washable, air dry (Do NOT machine dry)

Part Number	Size	Qty.
276-0491	Medium	Bulk - 6 pair
276-0492	Large	Bulk - 6 pair
276-0493	Extra Large	Bulk - 6 pair
276-0494	XX Large	Bulk - 6 pair

Personal Protective Equipment — Gloves

Impact Gloves



Warranty: Cat Standard Warranty, 6 Months

- Design features improved dexterity and glove life
- Compression-molded Airprene knuckle and index finger protection
- Seamless index finger for great fingertip control
- Streamlined thermal plastic rubber (TPR) hook and loop fastening on cuff
- Split palm design puts 1 mm material in all high wear areas
- 3 mm gel palm padding reduces vibrations
- NOT flame-proof or fire retardant
- Machine washable, air dry (do NOT machine dry)

Part Number	Size	Qty.
276-0499	Medium	Bulk - 6 pair
276-0500	Large	Bulk - 6 pair
276-0501	Extra Large	Bulk - 6 pair
276-0502	XX Large	Bulk - 6 pair

Insulated Gloves



Warranty: Cat Standard Warranty, 6 Months

- Improved thermal protection
- Unique combination of Velboa and micro fleece layer closest to skin for warmth
- Neoprene cuff design with streamlined thermal plastic rubber (TPR) hook and loop fastening
- Compression-molded neoprene knuckle and index finger protection
- Durable synthetic leather palm
- NOT flame-proof or fire retardant
- Machine washable, air dry (do NOT machine dry)

Part Number	Size	Qty.
276-0495	Medium	Bulk - 6 pair
276-0496	Large	Bulk - 6 pair
276-0497	Extra Large	Bulk - 6 pair
276-0498	XX Large	Bulk - 6 pair

Personal Protective Equipment — Gloves

Fingerless Gloves



Warranty: Cat Standard Warranty, 6 Months

- Protect hands while having full fingertip access
- Palm padding of 3 mm shock-absorbing gel
- Hidden seam design eliminates snagging
- Tough spandex top material resists snags
- Snug, comfort fit assures greater dexterity
- NOT flame-proof or fire retardant
- Machine washable, air dry (do NOT machine dry)

Part Number	Size	Qty.
276-0487	Medium	Bulk - 6 pair
276-0488	Large	Bulk - 6 pair
276-0489	Extra Large	Bulk - 6 pair
276-0490	XX Large	Bulk - 6 pair

Padded Utility Glove



Warranty: Cat Standard Warranty, 6 Months

- Yellow and Black
- Synthetic Leather Palm
- Synthetic Leather Fingertips
- Spandex Back
- Padded Palm
- Breathable Mesh
- Adjustable Wrist Strap
- CE marked, EN388: 1121, AS/NZS2161.2

Part Number	Size
377-5737	Medium
377-5738	Large
377-5739	X Large
377-5740	XX Large
377-5741	XXX Large

Personal Protective Equipment — Gloves

High Visibility Padded Utility Glove



Warranty: Cat Standard Warranty, 6 Months

- High-Visibility Green
- Synthetic Leather Palm
- Synthetic Leather Fingertips
- Reflective Tape Fingertips and Knuckle Strap
- Nylon Black
- Padded Palm
- Reflective Tape
- Adjustable Wrist Strap
- CE marked, EN388: 1121, AVS/NZS

Part Number	Size
377-5734	Medium
377-5735	Large
377-5736	X Large

Water-Resistant Utility Glove



Warranty: Cat Standard Warranty, 6 Months

- Gray
- Synthetic Leather Palm
- Neoprene Back
- Padded Palm
- Reinforced Thumb
- Silicone Grip Fingers
- Reflective Piping
- Adjustable Wrist Strap
- CE marked, EN388: 1121, AVS/NZS

Part Number	Size
377-5753	Medium
377-5754	Large
377-5755	X Large

Personal Protective Equipment — Gloves

Leather-Driver Glove



Warranty: Cat Standard Warranty, 6 Months

- Unlined
- Double-Stitched
- Palm Patch
- Ball and Tape Closure
- Gunn Cut with Keystone Thumb
- CE marked, EN388: 3122, AVS/NZS

Part Number	Size
377-5742	Medium
377-5743	Large
377-5744	X Large
377-5745	XX Large
377-5746	XXX Large

High-Visibility Leather Driver Glove



Warranty: Cat Standard Warranty, 6 Months

- High-Visibility Green
- Pearl Grain Pigskin Leather
- Gunn Cut with Wing Thumb
- Elastic Wrist
- CE marked, EN388: 4122, AVS/NZS

Part Number	Size
377-5732	Large

High-Visibility Leather Palm Glove



Warranty: Cat Standard Warranty, 6 Months

- High-Visibility Green
- Grain Pigskin Leather
- Finger Tips and Knuckle Strap
- Gunn Cut with Wing Thumb
- Rubberized Safety Cuff
- Elastic Wrist
- CE marked, EN388: 4122, AVS/NZS

Part Number	Size
377-5733	Large

Personal Protective Equipment — Gloves

Fingerless Leather Glove



Warranty: Cat Standard Warranty, 6 Months

- Black
- Reversed Pigskin Leather Palm
- Spandex Black
- Breathable
- Double-Stitched
- Adjustable Wrist Strap
- CE marked, EN388: 1220, AS/NZS2161.2

Part Number	Size
377-5756	Medium
377-5757	Large
377-5758	X Large

Unlined Grain Leather Driver's Gloves



Warranty: Cat Standard Warranty, 6 Months

- For drivers, utility, and warehouse workers
- Gunn cut pattern
- Keystone thumb
- Pull-strap closure
- CE-marked, meets EN388, AVS/NZS
- Package of 12

Part Number	Size
282-9529	Large
282-9530	Extra Large

Lined Leather Driver's Gloves



Warranty: Cat Standard Warranty, 6 Months

- For drivers, utility and warehouse workers
- Extra warmth
- Elastic shirred back holds glove securely to hand
- Gunn cut pattern

Part Number	Size	Qty.
246-5147	Extra Large	12 Pair with Hang Tags
246-5149	Large	12 Pair with Hang Tags
246-5151	Medium	12 Pair with Hang Tags

Personal Protective Equipment — Gloves

Split Leather Palm Gloves



Warranty: Cat Standard Warranty, 6 Months

- For tough rugged jobs
- Full leather index finger
- Lined palm and leather tips
- Gauntlet cuff style
- Elastic on back with knuckle strap

Part Number	Size	Qty.
246-5155	Large	12 Pair with Hang Tags

Split Cowhide Palm Gloves



Warranty: Cat Standard Warranty, 6 Months

- For medium- to heavy-duty work
- Gunn cut pattern
- Full leather index finger
- Wing thumb

Part Number	Size	Qty.
282-9531	Medium	Bulk - 12 Pair
282-9532	Large	Bulk - 12 Pair
282-9533	Extra Large	Bulk - 12 Pair

Traditional All-purpose Gloves



Warranty: Cat Standard Warranty, 6 Months

- For general work
- Cotton blend
- Knit wrist cuff
- Plastic dots on inner side and back of index finger

Part Number	Size	Qty.
246-5163	Large	Bulk - 12 Pair

Personal Protective Equipment — Gloves

Fleece-Lined Dotted Jersey Glove



Warranty: Cat Standard Warranty, 6 Months

- Black
- Cotton Jersey
- Fleece Lined
- PVC Dotted Palm and Fingers
- Gunn Cut with Continuous Thumb
- Open Cuff
- CE marked, EN388: 0221, AS/NZS2161.2

Part Number	Size
377-5747	Large

Dotted Jersey Glove



Warranty: Cat Standard Warranty, 6 Months

- Black
- Cotton Jersey
- Micro-Dotted Palm and Fingers
- Gunn Cut with Continuous Thumb
- Knit Wrist
- CE marked, EN388: 1111, AS/NZS2161.2

Part Number	Size
377-5748	Medium
377-5749	Large

Jersey Gloves



Warranty: Cat Standard Warranty, 6 Months

- For general purpose use
- Soft knit fabric
- Stretch to provide excellent fit
- CE marked, EN388

Part Number	Size	Qty.
246-5165	Large	12 Pair with Hang Tags
385-5557	Large	Bulk - 144 Pairs

Personal Protective Equipment — Gloves

Fleeced Gloves



Warranty: Cat Standard Warranty, 6 Months

- For outside work
- Knit wrist cuff
- Double layer of fabric
- Added warmth

Part Number	Size	Qty.
246-5167	Large	Bulk - 12 Pairs

Leather Welding Gloves



Warranty: Cat Standard Warranty, 6 Months

- One piece back fully welted
- Color: Gold

Part Number	Size	Qty.
247-4447	Large	Single Pair

Chemical-resistant Nitrile Gloves



Warranty: Cat Standard Warranty, 6 Months

NOTE:

When using gloves as Personal Protection Equipment (PPE), always consult the Material Safety Data Sheet (MSDS) for the chemical that is being handled for the most appropriate glove.

- Protect against cuts, abrasions, punctures, and snags
- Embossed texture improves grip
- Will not swell or weaken like rubber or neoprene in solvents and fats

Part Number	Size	Thickness	Application	Chemical Resistance	Qty.
4C-5522	L	15 mil	Chemical Handling Acids, Solvents, Caustics, Oils, Grease, Degreasing Machine operations using cutting oil, metal fabrication	Sodium Hydroxide, Freon, Xylene, Hydro-chloric Acid, Stoddard Solvent, Potassium Hydroxide, Perchloroethylene, Phosphoric Acid	Bulk - 12 Pair
4C-5523	XL	22 mil	Chemical Handling Acids, Solvents, Caustics, Oils, Grease, Degreasing Better protection than 4C-5522 due to thickness.	Sodium Hydroxide, Freon, Xylene, Hydro-chloric Acid, Stoddard Solvent, Potassium Hydroxide, Perchloroethylene, Phosphoric Acid	Bulk - 12 Pair

Personal Protective Equipment — Gloves

Neoprene-coated Gloves



Warranty: Cat Standard Warranty, 6 Months

- For working with acids, solvents, oils, caustics and greases
- High cut resistance compared to rubber and vinyl
- Good from 46°C to 149°C (-50°F to 300°F)

Part Number	Size	Qty.
246-5164	Large	12 Pair

Nitrile-coated Knit-lined Gloves



Warranty: Cat Standard Warranty, 6 Months

- For dry and light oil applications
- Resistance to cuts and abrasions
- Porous coating is soft and flexible
- Excellent grip
- CE Cat. 11

NOTE: When using gloves as Personal Protection Equipment (PPE), always consult the Material Safety Data Sheet (MSDS) for the chemical that is being handled for the most appropriate glove.

Part Number	Size	Qty.	Application	Chemical Resistance
4C-5526	Large	12 pair per package	Light to medium duty, general purpose, fabrication, assembly, maintenance, shipping, and receiving. Excellent grip in light oil applications.	Oil, Grease

Neox Gloves with Neoprene Coating



Warranty: Cat Standard Warranty, 6 Months

- Resistance to cuts, abrasions, and chemicals
- Interlock knit lining enhances puncture and snag resistance
- Two-piece lining eliminates irritating seams

NOTE: When using gloves as Personal Protection Equipment (PPE), always consult the Material Safety Data Sheet (MSDS) for the chemical that is being handled for the most appropriate glove.

Part Number	Size	Qty.	Application	Chemical Resistance
4C-5527	One size fits most	12 pair per package	Resists Heat, Cutting, Use in Plating, Galvanizing Degreasing, Petrochemicals	Acids, Solvents, (Ex.:Glycol Ether), Oils, Caustics, Soaps, Alcohols

Personal Protective Equipment — Gloves

Neoprene-coated Knit-lined Gloves



Warranty: Cat Standard Warranty, 6 Months

- For full-arm protection when using chemicals
- Broad protection against cuts and abrasions
- Resist oils, caustics, acids, alcohol, and solvents
- Fabric lining enhances puncture and snag resistance
- CE Marked, EN388:3222, EN511:121, EN374, EN374:AKL, EN407:43XXXX

NOTE: When using gloves as Personal Protection Equipment (PPE), always consult the Material Safety Data Sheet (MSDS) for the chemical that is being handled for the most appropriate glove.

Part Number	Size	Qty.	Application	Chemical Resistance
4C-5529	One size fits most	Single Pair	Resists Heat, Cutting, Use in Plating, Galvanizing, Sandblasting Cabinet	Acids, Solvents, (Ex:Glycol Ether), Oils, Caustics, Soaps, Alcohols

Best Nitrile Disposable Gloves



Warranty: Cat Standard Warranty, 6 Months

- 0.10 mm thick
- Powder free
- Rolled Cuff keeps dirt out
- Low allergy risk
- Smooth finish
- Box of 100
- CE marked, Cat 1

Part Number	Size
381-7612	Medium
381-7613	Large
381-7614	X Large

Disposable Powder-Free Nitrile Gloves



Warranty: Cat Standard Warranty, 6 Months

- Superior resistance to abrasives, chemicals, and punctures
- Contains no latex
- 5 mil thick
- CE Marked, meets EN 388:1994 and EN 374-3:1994

Part Number	Description	Size	Qty.
246-5180	Powder-Free	Large	100 per box
259-7007	Powder-Free	Medium	100 per box
259-7008	Powder-Free	Extra Large	100 per box

Personal Protective Equipment — Gloves

Disposable Powdered Nitrile Gloves



Warranty: Cat Standard Warranty, 6 Months

- Superior resistance to abrasives, chemicals, and punctures
- Contains no latex
- 5 mil thick
- CE Marked, meets EN 388:1994 and EN 374-3:1994

Part Number	Description	Size	Qty.
246-5179	Powdered	Large	100 per box
259-7005	Powdered	Medium	100 per box
259-7006	Powdered	Extra Large	100 per box

Disposable Latex Gloves



Warranty: Cat Standard Warranty, 6 Months

- For working with chemicals
- Extra stretch for best fit
- Excellent sensitivity touch
- Seamless construction
- Rubber latex
- 5 mil thick, 10 in long
- CE-marked, meets EN388: 1994 and EN374-3: 1994

Part Number	Size	Qty.
246-5181	Large	100 per box
260-1779	Extra Large	100 per box

Nitrile Coated Glove



Warranty: Cat Standard Warranty, 6 Months

- Yellow
- Nitrile-coated Nylon
- Adjustable wrist strap
- CE marked, EN388: 3121, AS/NZS2161.2

Part Number	Size
377-5759	Medium
377-5760	Large
377-5761	X Large

Personal Protective Equipment — Gloves

High-Visibility Nitrile Coated String Knit Glove



Warranty: Cat Standard Warranty, 6 Months

- High-Visibility Green
- Latex-Coated String Knit
- Textured for enhanced grip
- Cold Resistant
- Adjustable Wrist Strap
- CE marked, EN388: 2243, AS/NZS2161.2

Part Number	Size
377-5762	Medium
377-5763	Large
377-5764	X Large

Nitrile Coated Bamboo Glove



Warranty: Cat Standard Warranty, 6 Months

- Made of sustainable materials
- More comfortable and tougher than other fabrics
- Bamboo also breathes better, wicks away more moisture, and is cooler
- CE marked, EN388

Part Number	Size
385-5553	Large
385-5554	X Large
385-5555	XX Large

Cut Resistant Gloves, Level 2



Warranty: Cat Standard Warranty, 6 Months

- Lycra and Kevlar glove with Nitrile coated palm
- Strong and flexible
- Knit wrist
- ANSI cut level 2 protection
- CE marked, EN388:

Part Number	Size
381-7607	Medium
381-7608	Large
381-7609	X Large

Personal Protective Equipment — Gloves

Cut Resistant Gloves, Level 4



Warranty: Cat Standard Warranty, 6 Months

- Made of high performance polyethylene (HPPE), nylon and Spandex with a polyurethane coated palm
- Better gripping than nitrile coated gloves
- Strong and flexible
- Comfortable with excellent feel
- Breathable
- Knit wrist
- ANSI cut level 4 protection
- ANSI abrasion level 5 protection
- CE EN 388, EN 407

Part Number	Size
381-7611	Cut Resistant Gloves - Level 4

Nylon Gloves with Nitrile Coating



Warranty: Cat Standard Warranty, 6 Months

- For maintenance/assembly and shipping/receiving
- Excellent cut and abrasion resistances
- Good alternative to heavy cotton-coated gloves

Part Number	Size	Qty.
247-6412	Large	12 Pair with Hang Tags
247-6413	Extra-Large	12 Pair with Hang Tags

Personal Protective Equipment — Safety Vests

Safety Vests



Warranty: Cat Standard Warranty, 6 Months

262-9301 Lime Green Mesh Safety Vest

- Non-reflective, lime green color
- Front hook and loop closure with black cloth binding
- One size fits all
- Material: 100% polyester mesh

262-9176 Orange Mesh Safety Vest

- Non-reflective, dayglow orange color
- Front hook and loop closure
- Elastic side straps
- One size fits all
- Material: 100% polyester mesh

Part Number	Description	Color	Material
262-9176	Safety Vest	Orange	Polyester Mesh
262-9301	Safety Vest	Lime Green	Polyester Mesh

Personal Protective Equipment — Eye Protection

Cat Safety Glasses - Tread



Warranty: Manufacturer, 1 Year

- Lightweight and stylish
- Soft, vented nose piece
- Cushioned temple arms
- Three position adjustable temples with a snap-lock positioning
- Wrap lens
- Lenses and temples flex for a comfortable fit
- Full frames with vented top and bottom
- Crystal clear polycarbonate lenses
- Anti-scratch/anti-fog coating
- Weight - 1 oz (29 g)
- Retail Box and Packaging
- Cat branded
- ANSI Z87.1:2003, AS/NZS 1337:1992, CE marked, EN 166:2001, CSA Z94.3:2007

Part Number	Lens Type	Package Quantity
396-2013	Clear	10
396-2014	Smoke	10
396-2015	Blue Mirror	10

Cat Safety Glasses - Dozer



Warranty: Manufacturer, 1 Year

- Lightweight and stylish
- Rubber grip nose piece
- Four position adjustable temples with a snap-lock positioning
- Sides extendable by 0.5 in (12 mm)
- Lenses and temples flex for a comfortable fit
- 180 degree high wrap around style lens
- Crystal clear polycarbonate lenses
- Anti-scratch/anti-fog coating
- Weight - 0.84 oz (24 g)
- Retail Box and Packaging
- Cat branded
- ANSI Z87.1:2003, AS/NZS 1337:1992, CE marked, EN 166:2001, CSA Z94.3:2007

Part Number	Lens Type	Package Quantity
396-2010	Clear	10
396-2011	Smoke	10
396-2012	Blue Mirror	10

Personal Protective Equipment — Eye Protection

Cat Safety Glasses - Track



Warranty: Manufacturer, 1 Year

- Lightweight and stylish
- Lenses and temples flex for a comfortable fit
- 180 degree high wrap around style lens
- Soft tips
- Crystal clear polycarbonate lenses
- Anti-scratch/anti-fog coating
- Weight - 0.88 oz (25 g)
- Retail Box and Packaging
- Cat branded
- ANSI Z87.1:2003, AS/NZS 1337:1992, CE marked, EN 166:2001, CSA Z94.3:2007

Part Number	Lens Type	Package Quantity
396-2007	Clear	10
396-2008	Smoke	10
396-2009	Yellow	10

Cat Safety Glasses - Mortar



Warranty: Manufacturer, 1 Year

- Lightweight
- Lenses and temples flex for a comfortable fit
- 180 degree high wrap around style lens
- Crystal clear polycarbonate lenses
- Anti-scratch/anti-fog coating
- Weight - 0.811 oz (23 g)
- Retail Box and Packaging
- Cat branded
- ANSI Z87.1:2003, AS/NZS 1337:1992, CE marked, EN 166:2001, CSA Z94.3:2007

Part Number	Lens Type	Package Quantity
396-2005	Clear	10
396-2006	Smoke	10

Personal Protective Equipment — Eye Protection

Cat Safety Glasses - Grit



Warranty: Manufacturer's one year

- Super lightweight, fashion sunglasses styling
- Nylon frames with injected rubber temples and nose pad
- 180-degree high wrap around style lens
- High wrap molded lenses for optimal protection
- Crystal clear polycarbonate lenses
- Anti-scratch/anti-fog coating
- Weight – 1.05 oz (30g)
- Retail Box and Packaging
- Cat branded

ANSI Z87.1:2010, AS/NZS 1337:1, CE marked, CSA Z94.3:2007, EN 166:2011

Part number	Lens Type	Package Quantity
435-4061	Smoke	10

Cat Safety Glasses - Guard



Warranty: Manufacturer's one year

- Ultra-lightweight metal frames with spring hinges
- Rubber nose pad and temple tips
- 180-degree high wrap around style lens
- 100% optical lens clarity
- Anti-scratch/anti-fog coating
- Weight – 1.37 oz (39g)
- Retail Box and Packaging
- Cat branded

ANSI Z87.1:2010, AS/NZS 1337:1, CE marked, CSA Z94.3 :2007, EN 166:2011

Part Number	Lens Type	Package Quantity
460-3236	Clear	10
460-3237	Smoke	10

Personal Protective Equipment — Eye Protection

Cat Safety Glasses - Torque



Warranty: Manufacturer's one year

- Foam-lined safety glasses for dust proof fit
- Light and durable nylon chassis with indirect ventilation
- Detachable temples for use with the included strap
- 180-degree high wrap around style lens
- Crystal clear polycarbonate lenses
- Anti-scratch/anti-fog coating
- Weight – 1.79 oz (49g)
- Retail Box and Packaging
- Cat branded

ANSI Z87.1:2010, AS/NZS 1337:1, CE marked, CSA Z94.3.2007, EN 166:2011

Part Number	Lens Type	Package Quantity
460-3238	Clear	10
461-2616	Smoke	10

Wraparound Safety Glasses



Warranty: Cat Standard Warranty, 6 Months

- Visitor disposable safety glasses
- Can be worn over prescription glasses
- 99.9% UVA and UVB protection
- Meets or exceeds all ANSI, CSA, and CE specifications

Part Number	Description	Package Quantity
239-1085	Wraparound Safety Glasses	1

Safety Glasses



Warranty: Cat Standard Warranty, 6 Months

- 5-position ratchet and 4-position telescoping temples
- Soft non-slip rubber nosepiece
- Anti-scratch hard-coated lenses
- 99.9% UVA and UVB protection
- Ventilation between lens and frame
- Meets or exceeds all ANSI and CUL specifications

Part Number	Lens Type	Package Quantity
249-7265	Clear (packaged for industrial; 12 per package)	1

Personal Protective Equipment — Eye Protection

Safety Glasses



Warranty: Cat Standard Warranty, 6 Months

- 9.75 base lens provide excellent optics and protection
- Gel nosepiece allows for all day comfort
- 4 - position telescoping temples for superior fit
- All lens are hard coated for scratch resistance
- Meets ANSI Z87.1 + standards and protects against 99% harmful UV rays

Part Number	Lens Tint	Package Quantity
Industrial Packaging		
307-3013	Clear	12 per package
307-3014	Smoke	12 per package
307-3015	Indoor/Outdoor Use	12 per package

Safety Glasses



Warranty: Cat Standard Warranty, 6 Months

- Polarized lens provides superior glare control
- 5 position ratchet plus 4-position telescoping temples for superior fit
- Ventilation channel between lens and frame helps reduce fogging
- Meets ANSI Z87.1 + standards and protects against 99% harmful UV rays

Part Number	Package Quantity	Lens Type
Industrial Packaging		
309-4932	12 per package	Polarized

Safety Glasses



Warranty: Cat Standard Warranty, 6 Months

- Rubber tipped temples for comfortable fit
- Soft rubber nosepiece
- Tough polycarbonate lens provides superior protection
- Meets ANSI Z87.1 + and CUL standards and protects against 99% harmful UV rays

Part Number	Package Quantity	Lens Tint
Industrial Packaging		
307-3017	12 per package	Clear
307-3018	12 per package	Smoke
307-3019	12 per package	Indoor/Outdoor Use

Personal Protective Equipment — Eye Protection

Safety Glasses



Warranty: Cat Standard Warranty, 6 Months

- Sleek, sporty style frame
- Soft, rubber temples provide superior comfort
- Rubber nosepiece allows for all day comfort
- Comes standard with neck cord
- Meets ANSI Z87.1 + standards and protects against 99% harmful UV rays

Part Number	Package Quantity	Lens Tint
Retail Packaging (Clamshell)		
308-6384	Clamshell	Clear

Safety Glasses



Warranty: Cat Standard Warranty, 6 Months

Bi Focal Safety Glass

- Magnification diopter molded into lens
- Soft, rubber nosepiece
- Cushioned, non-slip rubber temple pads
- Meets ANSI Z87.1 + standards and protects against 99% harmful UV rays

Part Number	Package Quantity	Lens Type
Industrial Packaging		
308-6391	12 Per Package	Clear 1.0
308-6393	12 Per Package	Clear 1.5
309-2454	12 Per Package	Clear 2.0
309-2456	12 Per Package	Clear 2.5
309-2458	12 Per Package	Clear 3.0
Retail Packaging (Clamshell)		
309-2455	Clamshell	Clear 2.0

Safety Glasses



Warranty: Cat Standard Warranty, 6 Months

- Sleek, sporty, lightweight wraparound frame
- Gel nosepiece allows for all day comfort
- High gloss painted frame
- Comes standard with neck cord
- Cushioned, non-slip rubber temple pads
- Meets ANSI Z87.1 + standards and protects against 99% harmful UV rays

Personal Protective Equipment — Eye Protection

Safety Glasses (Cont'd.)

Part Number	Package Quantity	Lens Tint
Industrial Packaging		
307-3025	12 Per Package	Smoke

Personal Protective Equipment — Eye Protection

Safety Goggles



Warranty: Cat Standard Warranty, 6 Months

- Provides excellent ventilation and indirect protection
- Fits over most prescription eyewear
- Clear optical-grade polycarbonate lens
- Adjustable headband
- Meets or exceeds all ANSI specifications

Part Number	Description	Package Quantity
233-8584	Safety Goggles	1 Pair

Safety Goggles



Warranty: Cat Standard Warranty, 6 Months

- Perforated goggle with excellent ventilation and protection
- Fits over most prescription eyewear
- Clear optical-grade polycarbonate lens
- Adjustable headband
- CE Marked, ANSI 287.1, CUL, EN166

Part Number	Description	Package Quantity
233-8583	Vented Safety Goggles	1 Pair

Lanyard for Safety Glasses



Warranty: Caterpillar Standard Warranty, 6 Months

Universal lanyard to help you keep track of your safety glasses when moving into and out of the shop.

- Rubber tips slip right onto your safety glasses
- Cat branded slider adjusts to help keep your glasses snug

Part Number	Description
435-4062	Cat Lanyard

Personal Protective Equipment — Eye Protection

All-purpose Wipers



Warranty: Cat Standard Warranty, 6 Months

- Cleaning tissues for safety glasses
- Pop-up style box

Part Number	Description	Qty.	Size
263-0867	All-purpose Wipers	300 tissues per box, 60 boxes per case	127 mm x 203 mm (5 in x 8 in) wipers

Lens Cleaning Towelettes



Warranty: Cat Standard Warranty, 6 Months

European Union Compliant, CE marked

- Excellent disposable moisturized towels for lens cleaning
- Can be used on plastic, glass and polycarbonate lenses, face shields, and goggles
- Towelettes are pre-moistened with anti-fog, anti-static formula
- Individually foil wrapped towelettes are great for service trucks and tool boxes
- Dispenser features pull out bottom for easy dispensing and built in tab for hanging
- Each dispenser contains (100) 127 mm x 203 mm (5 in x 8 in) towelettes

Part Number	Description
239-1086	Lens Cleaning Towelettes (Individually Wrapped with Dispenser Box)

Lens Cleaning Station



European Union Compliant, CE marked

- May be used on safety glasses, face shields, goggles, and full face respirators
- Economical lens cleaning station provides lens cleaning needs in shop or office
- Promotes proper lens cleaning, extending life of safety glasses
- Specially formulated solution cleans greasy and oily glasses while providing an anti-fog/anti-static coating
- Low lint non-abrasive tissues leave lenses clear and streak free
- Easily mounted on wall or table top
- Each station contains 8 oz. anti-fog/anti-static solution and 600 low lint, non-abrasive tissues

Part Number	Description
239-1087	Lens cleaning station

Personal Protective Equipment — Eye Protection

Heavy-Duty Headgear



Warranty: Cat Standard Warranty, 6 Months

European Union Compliant, CE marked

- Headgear has precision ratchet head size adjustment for a comfortable snug fit
- Floating window suspension distributes weight and reduces shock of impact
- Five position pinlock crown band provides additional adjustment for proper support and a firm fit
- Crown protector made of a new high-performance thermoplastic offers excellent impact resistance over a wide range of temperatures
- Soft vinyl headband to cushion the forehead
- Packaged individually. Headgear and windows must be ordered separately.

4C-8096 and 4C-8097 Features

- 229 mm x 368 mm x 2.0 mm (9 in x 14 1/2 in x 0.080 in) thickness
- Polycarbonate for heavy-duty impact protection against flying particles
- Good heat resistance
- Provide excellent general face and eye protection
- Windows can be replaced in seconds
- Windows mount inside crown protector for greater splash protection
- Spring loaded pivot assemblies maintain proper friction and prevent annoying window drop
- Blue color and matte finish resist smudges and show less daily grime
- Packaged in quantities of 10

Part Number	Description
4C-8095	Heavy Duty Headgear
Accessories for 4C-8095	
4C-8096	Window - Clear Polycarbonate
4C-8097	Window - Dark Green for Glare Reduction

Face Shield



Warranty: Cat Standard Warranty, 6 Months

- Clear 203 mm x 305 mm x 1 mm (8 in x 12 in x .040 in) window
- Comfortable and durable
- Provide excellent general face and eye protection

Part Number	Description
1U-8095	Face Shield
Replacement Windows for 1U-8095 Face Shield (Also fit Glendale 5000, Huntsman K, K3, K4 and K10, Norton 6300 and Jackson J-10 face shields)	
1U-8096	Clear replacement window
4C-4404	Green replacement window

Personal Protective Equipment — Hearing Protection

Disposable Ear Plugs



Warranty: Cat Standard Warranty, 6 Months

European Union Compliant, CE marked

- Tapered disposable plug for excellent fit
- Light comfortable foam
- Smooth surface to repel dirt
- Excellent protection at NRR29

Part Number	Package Quantity
239-1090	1

Reusable Uncorded Ear Plugs



Warranty: Cat Standard Warranty, 6 Months

European Union Compliant, CE marked

- Super-soft washable reusable plugs
- Flip-top case included
- Non-toxic FDA-approved material
- Excellent protection at NRR28

Part Number	Package Quantity
239-1089	1

Disposable Foam Ear Plugs



Warranty: Cat Standard Warranty, 6 Months

European Union Compliant, CE marked

- Bell-shaped polyurethane foam for maximum comfort
- Smooth soil-resistant skin
- Noise reduction rating: 33dB
- NRR33, Canada Class A(L), SNR 37, SLL{80}26, Class 5, CA 14.114, EN352
- Color: neon

Part Number	Description	Qty.
260-4783	Uncorded Disposable Plugs	10 pc
260-4785	Corded Disposable Plugs	25 pc

Personal Protective Equipment — Hearing Protection

Band Ear Plugs



Warranty: Cat Standard Warranty, 6 Months

European Union Compliant, CE marked

- High-density construction, lightweight and durable
- Non-toxic FDA approved material earplugs
- Comfortable and cool on hot days
- Noise reduction rating: 23 dB
- Engineered angled earplug for maximum sound protection and comfort

Part Number	Description
233-8585	Rad Band
233-8586	Replacement Plugs

Silencer Ear Muffs



Warranty: Cat Standard Warranty, 6 Months

European Union Compliant, CE marked

- Comfortable adjustable padded headband
- Soft foam padded ear cups—comfortable when wearing with glasses
- Rugged and lightweight
- Dielectric
- Excellent protection at NRR26

Part Number	Description
233-8587	Silencer Ear Muffs

Multipositional Ear Muff



Warranty: Cat Standard Warranty, 6 Months

European Union Compliant, CE marked

- Adjustable steel headband
- Foam filled ear cushions with a soft breathable surface
- NRR at various positions:
 - NRR26 over-the-head
 - NRR26 behind-the-head
 - NRR23 under-the-chin

Part Number	Description	Package Quantity
239-1088	Multipurpose Ear Muff	1

Personal Protective Equipment — Hearing Protection

Ear Muffs



Warranty: Cat Standard Warranty, 6 Months

European Union Compliant, CE marked

- Hard hat-mounted ear muffs feature large, lightweight ear cups that attach to a variety of hard hats for convenience
- Recommended for moderately high noise situations (up to 95 dBA TWA)
- Noise reduction rating: 23 dB

Part Number	Description	Package Quantity
4C-6581	Ear Muffs	2 pair

Personal Protective Equipment — Hard Hats

Hard Hats



Warranty: Caterpillar Standard Warranty, 6 Months

- High-density polyethylene
- Self-sizing, four-point suspension with brow pad
- Rain trough brim provides extra protection against snow, rain, dust, and dirt
- Attachment points for accessories like: earmuffs, face shields, flashlights, etc.
- Meets or exceeds ANSI/ISEA Z89.1-2009, Type 1, Class E and G, CSA Z94.1-2005, Type 1, Class E and G, EN 397

Hard Hats	
Yellow	437-1415
White	437-1416

Hard Hat Winter Liner



Warranty: Cat Standard Warranty, 6 Months

European Union Compliant, CE marked

- Wear with 239-4964, 239-4965, 239-4966, and 239-4967 Hard Hats
- Dark blue cotton twill with fleece lining
- Comes with a hook and loop chin strap fastener
- Will work with other similar hard hats

Part Number	Description
1U-8091	Hard Hat Winter Liner

Personal Protective Equipment — Breathing Protection

Particulate Respirator

Warranty: Cat Standard Warranty, 6 Months

193-0071



193-0766



- Replaces 4C-8761 Dust/Mist Respirator
- 193-0766 and 193-0071 meet NOISH 42 CFR 84 N95 requirements. TC-84A2668 and TC-84A2669
- Three-panel respirator with innovative design allows better visibility and conforms to a wide range of face sizes
- Soft cover web on inner panel is comfortable against face and helps provide a custom fit and secure seal
- Individually packaged to help prevent contamination
- 193-0071 features the Cool Flow™ exhalation valve for easy exhalation and cool dry comfort
- Suggested applications: grinding, sanding, sweeping, bagging, general maintenance, dusty operations and operations involving liquid or non-oil based particle from sprays that do not emit harmful vapors

Part Number	Description	Qty.
193-0071	Particulate Respirator	10 respirators per box
193-0766	Particulate Respirator	20 respirators per box

Welding Respirator

Warranty: Cat Standard Warranty, 6 Months



- Meets NOISH 42 CFR 84 N95 requirements. TC-84A0454
- Cool flow exhalation valve promotes worker comfort by offering easy exhalation for cooler, dry comfort
- Contours easily to provide a comfortable, good seal
- Economical all-filter design with no spare parts to clean
- Suggested applications: welding, brazing, soldering, torch cutting, metal pouring, grinding, sanding, sweeping, bagging, general maintenance and operations involving liquid or non-oil based particle from sprays that do not emit harmful vapors

Part Number	Description	Qty.
237-5181	Welding Respirator	10 respirators per box

Personal Protective Equipment — Breathing Protection

Dust Mask



Warranty: Cat Standard Warranty, 6 Months

- Adjustable metal nose bridge, single strap, and contour-fit design to ensure best coverage
- Lightweight and disposable
- Non-irritating to the skin
- Not NIOSH approved
- Material: polyester

Part Number	Description	Qty.
262-4866	Reusable Polyester Dust Mask	50 respirators per box

Personal Protective Equipment — First Aid Kits

Personal First Aid Kit - 150-1578



Warranty: Cat Standard Warranty, 6 Months

- Small, portable kit for service trucks, tool boxes, or for personal use in family home, car, camper, or boat
- Soft shell case made of water resistant nylon
- Uses “Book Style” construction with zippered internal compartments (makes it easy to access items)

150-1578 consists of:		
Description	Size	Quantity
Water resistant nylon container	190.5 x 38.1 x 107.95 mm (7.5 x 1.5 x 4.25 in)	1
Scissors	102 mm (4.0 in)	1
Tweezers	76.2 mm (3 in)	1
First aid booklet		1
Band-aids	19.05 x 76.2 mm (.75 x 3 in)	20
Alcohol swabs		6
Wet wipes		4
Antiseptic swabs		12
Adhesive tape	2.3 m x 12.7 mm (2.5 yd x .5 in)	1
Sterile gauze pads	50.8 x 50.8 mm (2 x 2 in)	4
Sterile gauze pads	101.6 x 101.6 mm (4 x 4 in)	2
Sterile abdominal pad	127 x 228.6 mm (5 x 9 in)	1
Sterile pressure bandage	50.8 mm (2 in)	1
Conform gauze roll	4.57 m x 50.8 mm (5 yd x 2 in)	1
Triangular bandage		1
Safety pins		6
Vinyl gloves		1 pair
Acetaminophen		1 (2 per pack)

Part Number	Description
150-1578	Personal First Aid Kit

Personal Protective Equipment — First Aid Kits

Portable First Aid Kit - 150-1579



Warranty: Cat Standard Warranty, 6 Months

- Small, portable kit for service trucks, tool boxes, or for personal use in family home, car, camper, or boat
- Soft shell case made of water resistant nylon
- Uses "Book Style" construction with zippered internal compartments (makes it easy to access items)

150-1579 Consists of:		
Description	Size	Quantity
Water resistant nylon container	228.6 x 76.2 x 127 mm (9 x 3 x 5 in)	1
Scissors	152.4 mm (6 in)	1
Stainless steel splinter forceps	114 mm (4.5 in)	1
First aid booklet		1
Cloth bandaids	22.2 x 76.2 mm (.87 x 3 in)	10
Finger tip bandaids		5
Knuckle bandaids		5
Alcohol swabs		24
Wet wipes		6
Antiseptic swabs		16
Adhesive tape	4.6 m x 25.4 mm (5 yd x 1 in)	1
Sterile gauze pads	50.8 x 50.8 mm (2 x 2 in)	8
Sterile gauze pads	101.6 x 101.6 mm (4 x 4 in)	2
Sterile abdominal pad	127 x 228.6 mm (5 x 9 in)	2
Sterile pressure bandage	101.6 mm (4 in)	1
Conform gauze roll	4.57 m x 50.8 mm (5 yd x 2 in)	2
Triangular bandage		1
Safety pins		6
Vinyl gloves		1 pair
Multi-purpose pad	431.8 x 609.6 mm (17 x 24 in)	1
Tensor bandage	50.8 mm (2 in)	1
Instant cold pack (in box)	1016 x 152.4 mm (4 x 6 in)	1
Emergency mylar blanket		1

Part Number	Description
150-1579	Portable First Aid Kit

Personal Protective Equipment — First Aid Kits

Worksite First Aid Kits, 25 and 50-person

Warranty: Cat Standard Warranty, 6 Months

- Kits for your safety and first aid requirements
- Comply with OSHA 1910.151 for industry, and OSHA 1926.50 for construction
- 163-0798 contains supplies for 25 people; 163-0799 contains supplies for 50 people
- Soft shell case

Contents	163-0798 25-person	163-0799 50-person
Adhesive Strips, 3/4 in x 3 in	50	100
Adhesive Tape Roll, 1/2 in x 5 yd	1	1
Alcohol Wipes	13	23
Ammonia Inhalants	3	3
Instant Cold Pack	1	1
Combine Pad, 5 in x 9 in	1	1
Sterile Cotton, 1/2 oz roll	1	1
Disposable Gloves	1 pr	2 pr
Eye Irrigate Solution, 1 oz bottle	1	1
Eye Pads, oval, 1.75 in x 2.5 in	2	4
Gauze Pads, 4 in	2	4
Gauze Pads, 3 in	4	8
First Aid Cream, 7/8 oz	1	2
Triangular Bandage	1	1
Gauze Bandage, 2 in x 5 yd	2	2
Gauze Bandage, 4 in x 5 yd	—	1
Elastic Bandage, 2 in	—	1
Scissors	1	1
Tweezers	1	1

Part Number	Description
163-0798	Small Worksite First Aid Kit (25-Person)
163-0799	Large Worksite First Aid Kit (50-Person)

Personal Protective Equipment — First Aid Kits

First Aid Kit - 389-2195



Warranty: Cat Standard Warranty, 6 Months

- Worksite first aid kit
- Metal Box
- Designed to meet DIN 13164

389-2195 consists of:	
1	Certi-Tape
1	2-inch Stretch Gauze Roll
1	3-inch Stretch Gauze Roll
1	Rescue Blanket
1	Bandage Scissors
1	First Aid Fact Sheet
1	Safety Flag
3	ANSI Z308.1.2009 Triangular Bandages
4	ANSI Z308.1.2009 Nitrile Gloves
6	Certi-Gauze Pads
7	Certi-Gauze Bandage Compresses in various sizes
8	Extra Large Plastic Certi-Strips

Part Number	Description
389-2195	First Aid Kit

Personal Protective Equipment — Welding Protection

Welding Helmet



Warranty: Cat Standard Warranty, 6 Months

- 51 mm x 108 mm (2 in x 4 1/4 in), "shade 10" lens
- Ratcheting headgear adjusts to fit any head size
- Nylon material is lightweight and durable

Part Number	Description
1U-8097	Welding Helmet

Welding Helmet



Warranty: Cat Standard Warranty, 6 Months

- Features a shade 10 lens but in a larger size - 114 mm x 133 mm (4 1/2 in x 5 1/4 in)
- Has ratcheting head gear
- Made of sturdy nylon material

Part Number	Lens Type	Lens Use For:
1U-8100	Welding Helmet	—
Replacement Lens for 1U-8097 and 1U-8100 Welding Helmets		
1U-8099	Plastic Cover Plates ⁽¹⁾	1U-8097
1U-8101	Shade 10 Tinted Glass ⁽²⁾	1U-8100
1U-8209	Shade 10 Tinted Glass ⁽²⁾	1U-8097

Welding Goggles



Warranty: Cat Standard Warranty, 6 Months

- Feature a shade 5 lens, good ventilation, and a light-tight fit

Part Number	Description
1U-8103	Welding Goggles° ° μ ddd

1 Two needed, one inside and one outside of your tinted glass lens

2 Shade 10 lens used for welding with manual weld electrodes

Personal Protective Equipment — Welding Protection

Welding Goggles with Lift Front Lens



Warranty: Cat Standard Warranty, 6 Months

- Feature the shade 5 lens with a hinged front-lift door

Part Number	Description
1U-8104	Welding Goggles with Lift Front Lens

Welding Blanket



Warranty: Cat Standard Warranty, 6 Months

- Made of a fiberglass textile material
- Light gold neoprene coating on one side to reduce fraying
- Hemmed and seamed with Kevlar thread
- Retains heat
- Protects welding area

Part Number	Description	Dimensions
4C-9616	Blanket	183 cm x 183 cm (6 ft x 6 ft)
4C-9617	Blanket	183 cm x 244 cm (6 ft x 8 ft)
4C-9618	Blanket	183 cm x 305 cm (6 ft x 10 ft)

Contamination Control

Engine Cover



Warranty: Manufacturer's

- Protects engine from dirt and debris
- Can be used as drop cloth or dust cover
- Affordable and disposable

Part Number	Size	Qty.
1U-7427	122 x 183 cm (48 x 72 in)	50 sheets per case

Seat Covers



Warranty: Cat Standard Warranty, 6 Months

- These seat covers drape over the seats and are disposable when the job is finished
- They are produced from a specially formulated resin that has a built-in stretch to help prevent tool punctures and rips. These covers are made of a clear non-slip surface on both sides that helps hold it in place while providing safe usage.

Part Number	Description
274-7454	Roll of 250 seat covers
274-7455	Case of 250 seat covers

Wall Mount Dispenser



Warranty: Cat Standard Warranty, 6 Months

- Space saver wall dispenser mounts with ease to accommodate seat cover rolls
- This dispenser will help keep your interior protection products clean and easy to reach

Part Number	Description
274-7458	Seat cover roll dispenser

Floor Cover



Warranty: Cat Standard Warranty, 6 Months

- Interior service soils are the single most frequent complaint by service customers. Help keep the inside clean with these floor covers that stay in place. These covers have a high absorption paper on top and a plastic bottom that won't soak through

Part Number	Description
274-7456	Case of 500 floor covers

Cabinet Cover - 449-8227

Warranty: Manufacturer's

- Durable PVC material that protects dirt, dust, wind and rain
- Drawstring cinches tight for a snug fit that won't blow away
- Dimensions are 187.96 x 213.36 x 137.16 cm (74 x 84 x 54 in)
- 793F AC requires waterproof cover for resistor grid and inverter cabinet during service

AC Resistor Grid and Inverter Cabinet Cover (Yellow)		
Use	Size	Part Number
Cabinet cover for 793F AC	187.96 x 213.36 x 137.16 cm (74 x 84 x 54 in)	449-8227

Steering Wheel Covers



Warranty: Cat Standard Warranty, 6 Months

- The see-thru steering wheel cover protects your customer's steering wheel from oily prints. It is elasticized on both sides providing protection for the wheel and the customer's hands. Impervious to grease, these afford maximum protection for the wheel.

Part Number	Description
274-7457	Case of 500 covers

Dust Cap for 55 Gallon Drum



Warranty: Cat Standard Warranty, 6 Months

- Excellent for covering open drum containers
- Ideal for most industrial, food, chemical, and pharmaceutical applications
- Low cost protection from dirt, dust, and moisture
- Prevents contamination and evaporation
- Elastic around entire opening helps keep cover in place
- Provides easy access to contents
- Fits a 208.2 L (55 gal) drum

Part Number	Size	Qty.
270-5347	863.6 mm (34 in) diameter	100 per box

Contamination Control

Barrel Cover



Warranty: Cat Standard Warranty, 6 Months

- Used to cover open or closed top drums — cover snaps onto top of drum
- Supports the Caterpillar contamination control efforts
- Protects drum contents from water induction when stored outside
- Keeps drum top clean and contents ready for use
- Made of long lasting, low density polyethylene — resistant to petroleum-based fluids and ultraviolet rays
- 10 covers per package

Part Number	Material Thickness	I.D.	Color
1U-6156	1.5 mm (0.06 in)	571 mm (22.48 in)	Yellow

Zipper-Top, Clear Bags for Contamination Control

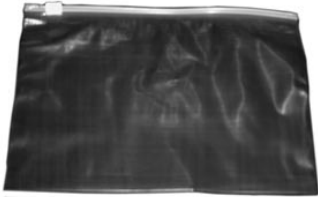

Warranty: Cat Standard Warranty, 6 Months

- Exceptional strength
- Plastic slider top for easy opening and closing
- Material: linear low density polyethylene (LLDPE)

Part Number	Size	Thickness	Qty.
270-5341	203 x 178 mm (8 x 7 in)	3.0 mm	250 bags/carton
270-5342	229 x 305 mm (9 x 12 in)	3.0 mm	250 bags/carton

Fluid Sampling Extraction Tools for Pressurized Compartments

Warranty: Cat Standard Warranty, 6 Months

- Valve locations provide oil sample confidence and continuity—comparative data of pressurized oil samples is more reliable because the sample is taken from a continuous flow of oil at a known location.
- A probe is provided that allows the valve to be quickly flushed prior to taking the oil sample
- The sample bottle group is packaged, and sealed in a plastic bag to insure cleanliness
- Pressurized oil sampling is a fast, economical and clean method of obtaining oil samples from pressurized systems
- Better represents oil condition because the oil is continually mixed and circulated
- 10 to 20 times faster than sampling oil from non-pressurized systems
- Mailing container is available so the oil sample can be conveniently mailed to the testing laboratory

This bottle group is sealed in a plastic bag with sampling instructions included. The bottle group is ready to use when it is removed from the bag after the valve has been purged and the sample is ready to be taken. The bottle included in this group (169-7372) has the capacity to provide a 114 g (4 oz) sample. The 169-7372 can also be ordered by itself, 200 per case.

After the sample is obtained, the probe and tube are removed from the bottle cap and holder, and discarded, and the cap-cover seals the bottle. Labels for identifying the sample (obtained locally) can then be attached to send the oil for identification purposes. The 4C-4600 mail tube is available to send the oil sample to the laboratory. The laboratory also provides a mailing label.

169-8373 Bottle Group (Package Qty. - 300)

177-9343 Probe and Cap Group (package Qty. - 500)

The probe and cap group provides the same probe and cap that are used in the 169-8373 Bottle Group, however, without the bottle. This group is also sealed in a plastic bag with sampling instructions included. This group allows the dealer the flexibility to use other bottles such as the smaller 71 g (2 1/2 oz) 169-7373 bottle assembly (which must be ordered separately). (The cap requires that the bottles have a 38 M thread).

169-7373 Bottle Assembly (Package Qty. - 200)

This smaller bottle assembly (169-7373) can be used with the 177-9343 Probe and Cap Group and reduces mailing expense by approximately one-half for dealers whose oil sample labs can provide effective full service analysis with 71 g (2 1/2 oz) or less of oil. These bottles can be used for engine samples since particle count is not used for engine samples. This bottle can also be used with the 1U-5718 Vacuum Pump used for non-pressurized oil sampling.

8T-9208 Probe Assembly (package Qty. - 1)

The 8T-9208 Probe Assembly can be attached to a 6.35 mm (1/4 in) I.D. rubber hose (6K-0713 Hose - 228.6 mm (9 in) long or any desired length cut from bulk 5P-6442 hose or equivalent 100R6 type high temperature - low pressure hose). The 8T-9208 Probe and hose connected to a locally obtained waste container provide a method to purge or flush the 8C-3446, 8C-3345, or 7X-3387 sample valves prior to obtaining the desired oil sample using either the 169-7373 Bottle Group or 177-9343 Probe and Cap Group with the desired bottle. Approximately 14.8 cm to 29.6 cm (1/2 to 1 ounce) of expelled fluid purges the valves.

Pressurized systems on many Cat products are equipped with sampling valves to quickly extract oil samples with the above tools. Special Instruction SEHS9043 details retrofitting some earlier models with oil sampling valves, as well as pointing out the respective valve locations on models currently factory equipped with the oil sample valves.

Fluid Sampling Equipment

Fluid Sampling Extraction Tools for Pressurized Compartments (Cont'd.)

321-0659 8oz (240ml) Bottle and Cap (package Qty. - 1)

The 321-0659 Bottle and Cap can be used with the 293-8413 Hydac Contamination Monitor and the 202-2301 Portable Contamination Instrumental Kit.



Item	Part Number	Description	Package Quantity
1	169-8373	Bottle Group, 300 per box	300 per box
2	162-8873	Probe, Holder	—
3	177-9343	Probe and Cap Group, 500 per box	500 per box
4	4C-4600	Mailer Container — reusable Tube — 30.5 m (100 ft) rolls	—
5	1U-8757	6.35 mm OD x 30.5 m rolls (1/4 in OD x 100 ft) 5 rolls per box	5 rolls per box
6	4C-4056	7.9 mm OD x 30.5 m rolls (5/16 in OD x 100 ft) 5 rolls per box, not pictured	5 rolls per box
7	169-7373	Clear Bottle, 71 g (2.5 oz), 200 per box	200 per box
8	169-7372	Clear Bottle, 114 g (4 oz), 200 per box	200 per box
9	1U-5718	Vacuum Pump	—
10	8T-9208	Purging Probe ⁽¹⁾	—
11	6V-0852	Dust Cap (Blank) (not pictured)	
11	1U-7648	Tube Cutter	—
12	3J-7354	Seal - O-ring - STOR for 8C-3446 (not pictured)	
—	1U-5719	Seal Kit for 1U-5718 Pump (not pictured)	—
—	7X-3387	S-O-S Sampling Valve	
—	8C-3345	Oil Sampling Valve (M10 x 1 — ext thd)	
—	8C-3445	Dust Cap (Engine)	
—	8C-3446	Oil Sampling Valve (7/16 in-20 — ext. thd)	
—	8C-3447	Dust Cap (Transmission) (not pictured)	
—	8C-3451	Dust Cap (not pictured)	
—	8C-8456	Sealed Cap	
—	8T-7876	O-ring Seal for 8C-3345 (not pictured)	
Not shown			
—	321-0659	Bottle and Cap (8oz/240ml)	1
—	4C-4055	6.35 mm OD x 2.1 m (1/4 in OD x 7 ft), 250 pieces per box	250 per box
—	4C-4057	7.9 mm OD x 2.1 m (5/16 in OD x 7 ft), 240 pieces per box	250 per box
Oil Sampling Valves and O-Ring Seals			
12	3J-7354	Seal - O-ring - STOR for 8C-3446 (not pictured)	
—	7X-3387	S-O-S Sampling Valve	
—	8C-3345	Oil Sampling Valve (M10 x 1 — ext thd)	
—	8C-3446	Oil Sampling Valve (7/16 in-20 — ext. thd)	

¹ Warranty: Manufacturer's, 30-Day

Fluid Sampling Extraction Tools for Pressurized Compartments (Cont'd.)

Item	Part Number	Description	Package Quantity
–	8T-7876	O-ring Seal for 8C-3345 (not pictured)	
Protective Dust Caps for Oil Sampling Valves (These are rubber caps with embossed symbols to indicate system being sampled.)			
11	6V-0852	Dust Cap (Blank) (not pictured)	
–	8C-3445	Dust Cap (Engine)	
–	8C-3447	Dust Cap (Transmission) (not pictured)	
–	8C-3451	Dust Cap (not pictured)	
–	8C-8456	Sealed Cap	
Miscellaneous fittings and adapters commonly used for oil sampling valve retrofit installations			
2	3J-5390	Plug - NPTF (Ext Hex) 3/8 in-18 NPTF external to 1/8 in-27 NPTF internal	–
3	3B-7722	Bushing-Pipe-Reducing 3/8 in-18 NPTF to 1/4 in-18 NPTF	–
4	2S-4078	O-ring Seal for 9T-6865 Adapter Plug	
4	7M-8489	Adapter Assembly, 90° elbow 9/16 in-18 SAE external to 1/4 in-18 internal	
13	6V-3966	Pressure Test Valve, 1/4 in-18 NPTF external	
(not shown)	7J-8611	Elbow-90°-Pipe 1/4 in-18 NPTF	–
–	3J-1907	O-ring Seal for 5P-9617 Adapter	
–	3L-6521	Adapter Tee, 1/4 in-18 NPT (2 internal and 1 external)	–
–	5P-3413	Pipe Sealant, 47.25 g (1 2/3 oz) tube	–
–	5P-3501	Adapter, 9/16 in-18 SAE external to 1/4 in-18 NPTF internal	–
–	5P-9617	Adapter Reducer, 9/16 in-18 SAE external to 7/16 in-20 SAE internal	–
–	6V-7529	Adapter, 1/8 in-27 NPTF external to 7/16 in-20 SAE internal	–
–	8C-6427	Adapter, 1/4 in-18 NPTF external to 7/16 in-20 SAE internal	–
–	9T-6865	Adapter Plug, 5/8 in-12 SAE external to 7/16 in-20 SAE internal	–

Fluid Sampling Extraction Tools for Non-Pressurized Compartments

Warranty: Cat Standard Warranty, 6 Months

Fluid sampling extraction tools are used to obtain fluid samples from non-pressurized vehicle compartments such as final drives, differential compartments, transfer cases, axle housings, etc.

The 1U-5718 Vacuum Pump is capable of pulling 25 inch (7.62 mm) Mercury (vacuum). The pump is compact and accepts the 169-7372, 114 g (4 oz), and 169-7373 Bottle Assembly, 71 g (2 1/2 oz), bottles, or any 38 M threaded plastic bottle, and 6.35 mm (1/4 inch) O.D. and/or 7.9 mm (5/16 inch) O.D. plastic tube.

The 1U-5719 Kit provides replacement seals for the vacuum pump.

The 169-7372 bottle has 4 oz (114 g) capacity. The bottle is marked showing fluid full range at 3/4 capacity. The fill range provides a reminder to not overfill the bottle. Partially filling the bottle satisfies both mailing and lag requirements. Full bottles expand because of temperature changes and can possibly rupture within the mailing container. The partially filled bottle also allows the lab to shake the fluid sample prior to extracting fluid for testing. Labels identifying the fluid are obtained locally. The label is processed locally and attached to the sample bottle.

The 169-7373 bottle is the same as the 169-7372 bottle except the capacity is 71 g (2 1/2 oz) rather than 114 g (4 oz). Both are clear high performance plastic rated at 91° C (195° F).

Fluid Sampling Equipment

Fluid Sampling Extraction Tools for Non-Pressurized Compartments (Cont'd.)

1U-8757 Tubing consists of five 30.5 m (100 ft) rolls of 6.35 mm (1/4 inch) O.D. plastic tubing. Random lengths of tubing can be easily dispensed from the tubing package. This tubing permits extraction of heavier oils when using the vacuum pump.

Both tubing sizes are also available in pre-cut 2.1 m (7 ft) lengths that are packaged 250 pieces per box. This eliminates cutting the tube for each sample.

The 4C-4055 Tubing contains 250 pieces of 6.35 mm (1/4 inch) O.D. tubing each 2.1 m (7 ft) long.

The 1U-7648 tube cutter is a convenient tool that easily cuts the desirable length of either 6.35 mm (1/4 inch) or 7.9 mm (5/8 inch) plastic tubing. The cutter can cut the tubing at 90° or at a bias.

The following summarizes various sampling tools available through the Caterpillar Parts Distribution System:

Part Number	Description	Part Number	Description
169-7372	Clear Bottle, 114 g (4 oz), 200 per box	4C-4057	7.9 mm OD x 2.1 m (5/16 in OD x 7 ft), 240 pieces per box
169-7373	Clear Bottle, 71 g (2.5 oz), 200 per box	4C-4600	Mailer Container — reusable Tube — 30.5 m (100 ft) rolls
169-8373	Bottle Group, 300 per box	6V-0852	Dust Cap (Blank) (not pictured)
177-9343	Probe and Cap Group, 500 per box	7X-3387	S-O-S Sampling Valve
1U-5718	Vacuum Pump	8C-3345	Oil Sampling Valve (M10 x 1 — ext thd)
1U-5719	Seal Kit for 1U-5718 Pump (not pictured)	8C-3445	Dust Cap (Engine)
1U-7648	Tube Cutter	8C-3446	Oil Sampling Valve (7/16 in-20 — ext. thd)
1U-8757	6.35 mm OD x 30.5 m rolls (1/4 in OD x 100 ft) 5 rolls per box	8C-3447	Dust Cap (Transmission) (not pictured)
3J-7354	Seal - O-ring - STOR for 8C-3446 (not pictured)	8C-3451	Dust Cap (not pictured)
4C-4055	6.35 mm OD x 2.1 m (1/4 in OD x 7 ft), 250 pieces per box	8C-8456	Sealed Cap
4C-4056	7.9 mm OD x 30.5 m rolls (5/16 in OD x 100 ft) 5 rolls per box, not pictured	8T-7876	O-ring Seal for 8C-3345 (not pictured)
		8T-9208	Purging Probe ⁽²⁾

Oil Safe Containers



Warranty: Six months

- Prevents oil contamination
- Speeds up lubrication jobs
- Dispenses easily to awkward points
- Reduces spills and resulting accidents
- Expedites filling and refilling
- Leads to an organized workspace
- Pump fits 10L drum when coupled with a Utility Lid

2 Warranty: Manufacturer's, 30-Day

Oil Safe Containers (Cont'd.)

Part Number	Description
310-5744	Contamination Prevention Kit
310-5744 Consists of:	
–	Drum (3 l)
310-5678	Drum (5 l)
–	Drum (10 l)
–	Pump
–	Stretch Hose Extension

Part Number	Description
310-5715	Stumpy Spout Lid (Yellow)
–	Stretch Spout Lid (Blue)
–	Utility Lid (Red)
Accessories	
310-5713	Stumpy Spout Lid (Red)
310-5716	Stumpy Spout Lid (Lt. Green)

Towels and Wipers

DRC Quarter-Fold Wipers



Warranty: Cat Standard Warranty, 6 Months

- Highly absorbent material—cleans up oil, grease, water, and other messy fluids
- Strong and abrasion-resistant—resists tearing even when wet
- Offers a low-lint alternative
- Economical alternative to shop rags or towels
- Soft cloth-like feel

Part Number	Size	Color	Qty.
288-4209	31.75 x 33.02 cm (12.5 x 13 in)	White	56 wipers per bundle, 18 bundles per case

DRC Pop-Up Shop Towels



Warranty: Cat Standard Warranty, 6 Months

- Highly absorbent material—cleans up oil, grease, water, and other messy fluids
- Soft cloth-like feel
- Strong and abrasion-resistant—resists tearing even when wet
- Offers a low-lint alternative in a handy pop-up container

Part Number	Size	Color	Qty.
288-4210	24.13 x 41.91 cm (9.5 x 16.5 in)	White	100 towels per box, 9 boxes per case
288-4211	24.13 x 41.91 cm (9.5 x 16.5 in)	Blue	100 towels per box, 9 boxes per case

DRC Center-Pull Roll Dry Shop Towels



Warranty: Cat Standard Warranty, 6 Months

- Highly absorbent material—ideal for use on grease, oils, and other messy fluids
- Strong and abrasion-resistant—resists tearing even when wet
- Center-pull wiper wrapped in clear plastic film with re-closeable top tab for easy dispensing

Part Number	Size	Color	Qty.
288-4212	22.86 x 33.02 cm (9.0 x 13.0 in)	White	300 towels per roll, 1 roll per pack

DRC Center - Pull Shop Towels



Warranty: Cat Standard Warranty, 6 Months

- Economical alternative to shop cloths, without the mess
- Works like cloth but at a fraction of the cost
- Packaging keeps your shop towels clean and dry until needed
- Won't color bleed and no thread gaps
- Made with the strongest and heaviest DRC material on the market
- New center pull design allows for one towel to come out at a time
- Center-pull design holds until the last three towels
- Absorbs fluids on contact and lint free

Part Number	Description	Size	Qty.
303-9339	DRC Red Shop Towels	30.7 x 42.7 cm (12.1 x 16.8 in)	140 per roll

DRC Jumbo Roll Shop Towels



Warranty: Cat Standard Warranty, 6 Months

- Highly absorbent material—cleans up oil, grease, water, and other messy fluids
- Soft cloth-like feel
- Strong and abrasion-resistant—resists tearing even when wet

Part Number	Description	Size	Color	Qty.
301-9696	DRC Jumbo Roll Shop Towels	31.75 x 33.02 cm (12.5 x 13 in)	White	692 towels per roll, 1 roll per case
311-3136	Holder for 301-9696	—	—	5

All-Purpose Wipers



Warranty: Manufacturer's

- Highly absorbent—cleans up oil, grease, water and other messy fluids
- Strong and abrasion resistant—great wet-strength for scrubbing
- Pliable for reaching into tight places
- Soft for personal cleaning
- Low lint and won't leave a residue
- Economical alternative to shop rags or towels

Part Number	Size	Color	Qty.
265-2255	30.5 x 33 cm (12 x 13 in) quarter-folded	Blue	56 wipers per pack, 18 packs per case

Towels and Wipers

Wipers

Warranty: Cat Standard Warranty, 6 Months

- Designed to outperform rags with Hydroknit technology in lightweight wiper
- Reinforced for extra scrubbing and cleaning power
- Leaves no residue
- Good on grease and oil, adhesive cleaning and cable lubricant removal
- Good for applying thinners and solvents

Part Number	Size	Color	Qty.
254-3422	23.1 x 42.7 cm (9.1 x 16.8 in)	White	126 wipers per box, 10 boxes per case

Low Lint Task Wipers



Warranty: Cat Standard Warranty, 6 Months

- For lab environments where clean rooms require low lint
- Excellent for surface wiping in clean manufacturing environments—fuel systems, hydraulics, diagnostic equipment and precision instruments
- Continuous filament rayon/polyester spun-like blend for cloth-like feel
- Excellent absorption rate and capacity
- Solvent resistant
- Double wrapped in anti-stat packaging

Part Number	Size	Color	Qty.
265-2256	20.3 x 20.3 cm (8 x 8 in)	white	100 wipers per pack, 5 packs per case

Manufactured Rags



Warranty: Cat Standard Warranty, 6 Months

- HydroKnit fast-absorbing material—highly absorbent
- Cleans up oil, grime, and solvents
- Good for applying thinner and solvents
- Pound for pound absorbs more oil and water than shop rags
- Use with 1U-5432 Paper Wiper Dispenser

Part Number	Size	Color	Qty.
267-6532	31.8 x 36.6 cm (12.5 x 14.4 in)	white	76 wipers per bundle, 12 bundles per case

Manufactured Pop-up Rags



Warranty: Cat Standard Warranty, 6 Months

- HydroKnit fast-absorbing material—highly absorbent
- Reinforced for heavy maintenance cleaning and long-lasting performance that also reduces waste
- Cleans up oil, grime, and solvents
- Good for applying thinner and solvents
- Pound for pound absorbs more oil and water than shop rags
- Packaged in sturdy corrugated pop-up dispenser cartons
- Can also use with 269-3368 Dispenser

Part Number	Wiper Size	Color	Qty.
267-6535	23.1 x 42.7 cm (9.1 x 16.8 in)	white	100 rags per carton, 10 cartons per case
267-6536	23.1 x 42.7 cm (9.1 x 16.8 in)	blue	100 rags per carton, 10 cartons per case

Dispensers for Manufactured Rags and Paper Wipers



Warranty: Cat Standard Warranty, 6 Months

Part Number	Description	Usage
1U-5432	Paper Wiper Dispenser, Plastic	use for 267-6532 Manufactured Rags
269-3368	Dispenser, White Metal	use for 267-6535 and 267-6536 Manufactured Rags

Hard Roll Towels



Warranty: Cat Standard Warranty, 6 Months

- Towels compressed on roll so more towels fit in same space — no sacrifice in performance, change roll less often
- Material: paper

Part Number	Description	Size	Color	Package Quantity
263-0892	Hard Roll Towels	20.3 cm x 304.8 m (8 in x 1000 ft) roll	White	12 rolls

Towels and Wipers

Shop Towel



Warranty: Cat Standard Warranty, 6 Months

- Excellent absorbency
- Perfect to use on grease or oil
- Low-lint, 100% polypropylene construction
- Good for cleaning and disinfecting surface
- Stands up well to spirits and solvents

Part Number	Size	Qty.
162-5791	30.7 x 42.7 cm (12.1 x 16.8 in)	180 per box

Absorbents and Spill Kits — Absorbents

Oil Absorbent Pads



Warranty: Caterpillar Standard Warranty, Six Months

- Sonic-bonded Mats
- A lofty layer of randomly laid out melt-blow fibers enables the mat to absorb a large amount of oil
- Mats keep shape even when saturated
- Low lint

Part Number	Dimensions	Absorbency	Quantity
467-9234	15 in x 19 in (38 cm x 48 cm)	14 gallons (55 L)	50

Absorbent Socks



Warranty: Manufacturer's

- Tubular absorbent socks absorb and contain leaks and spills around machinery (hydraulic oil, coolants, non-aggressive fluids, water, and even hazardous fluids, such as PCB oils and solvents)
- Superior diking and damming capability (hugs the floor, creating an effective barrier or dike that holds back fluids, in emergency situations, even after total absorption)
- Used primarily for everyday housekeeping around machines that leak, seep, or spill fluids
- Fits snugly against machine bases and wrap-around corners, keeping work area safe and dry
- Fine-grade vermiculite filler (non-biodegradable) quickly soaks up leaks and drips
- Durable, stitch-bonded polypropylene skin improves strength
- Self-contained, no messy cleanup (no loose absorbents to spread, sweep, scatter, shovel, or track around)
- Reusable for water spills only
- Meets OSHA regulation 29 CFR 1910.22(a)(2) for dry and clean workplace floors
- Material Safety Data Sheets (MSDS) available
- Supplier-branded product

Reference: NELG5036

Part Number	Quantity/Box	Absorption/Box	Absorption/Sock	Size	Shipping Weight
235-0844	40	113 L (30 gal)	2.8 L (.7 gal)	8 cm x 122 cm (3 in x 48 in)	23 kg (50.71 lb)
254-3969	8	57 L (15 gal)	6.8 L (1.8 gal)	75 mm (3 in) diameter x 3 m (10 ft) long	11 kg (24.25 lb)

Absorbents and Spill Kits — Absorbents

Absorbent Pillows



Warranty: Manufacturer's

- Absorbent pillow soaks up small to medium-size spills of oil and other non-aggressive fluids (works best once a spill has been contained)
- Fast, effective way to control leaks
- Use only as many as required (pillow's large surface area and superior wicking ability speeds cleanup time)
- High absorption/fast-wicking cellulose fibers begin to work when pillow contacts liquid and continue until fully saturated
- Strong, polypropylene cover will not tear when handling
- Easy cleanup (simply pick up and place into proper disposal container)
- Meets OSHA regulation 29 CFR 1910.22(a)(2) for dry and clean workplace floors
- Material Safety Data Sheets (MSDS) available
- Supplier-branded product

Reference

NELG5036

Part Number	Quantity/Box	Absorption/Box	Absorption/Sock	Size	Shipping Weight
235-0845	40	76 L (20 gal)	1.9 L (64 oz)	25 x 25 x 5 cm (10 x 10 x 2 in)	10 kg (23 lbs)

Absorbents and Spill Kits — Absorbents

Heavyweight Absorbent Material for Most Oil, Water-Based Fluids and Chemicals

Warranty: Manufacturer's

Absorbs the following fluids and chemicals:

Acetone, Acetonitrile, Aluminum Salts, Ammonium Hydroxide, Barium Salts, Benzyl Alcohol, Boric Acid, Butanol, Calcium Chloride, Carbon Disulfide, Carbon Tetrachloride, Chloroform, Cupric Chloride, Cyclohexanone, Dichloromethane, Diethylamine, Dimethylformamide, Ethyl Acetate, Formaldehyde, Gasoline, Glycol Ether, Hexane, Hydrazine, Anhydrous, Hydrochloric Acid (37%), Hydrogen Peroxide (30%), Hydrofluoric Acid (48%), Isopropanol, Jet Fuel (JP-5), Kerosene, Methanol, Methyl Ethyl Ketone, Mineral Oil, Mineral Spirits, Naphtha, Nitric Acid (70%), Nitric Acid fuming (90%), Nitrobenzene, Perchloroethylene, Phenol, Potassium Hydroxide 50%, Propylene Glycol, Sodium Hydroxide (50%), Styrene, Sulfuric Acid (50%), Sulfuric Acid (98%), Tetrachloroethylene, Tetrahydrofuran, Thionyl Chloride, Toluene, 1, 1, 1-Trichloroethane, Trichloroethylene, Triethylamine, Turpentine, Water



261-0114

- Heavyweight, gray, absorbent material designed to absorb chemicals, solvents, oils, coolants, petroleum products, water, water-based fluids, and even acids and bases
- Multiple uses in maintenance, repair, and operating (MRO) areas; cover areas prone to overspray and spills, leaving a cleaner, safer work area; ideal for heavy, concentrated machine leaks and large, spreading spills; keep floors and walk areas safer by absorbing leaks, spills, drips, and overspray
- Dark gray color hides dirt and grime of foot traffic
- Thin profile slides into hard-to-reach areas
- Made from flame-resistant material which can be used around spark-prone areas, such as welding or grinding equipment
- Material will not degrade or have a chemical reaction to a wide variety of chemicals and strong solvents
- Absorbs 10 times its weight, reducing material purchase and disposal costs
- Dimple design helps absorb more liquid in less time (material retains liquid, even when fully saturated)
- Roll material cuts easily with scissors or razor knife — easily shaped to fit virtually any area
- Material: 100% polypropylene
- Multiple layers are held together with thermal bond points for added strength and durability—will not fall apart or leave behind residue, even when fully saturated
- Meets OSHA regulation 29 CFR 1910.22(a)(2) for dry and clean workplace floors
- Material Safety Data Sheets (MSDS) available
- Supplier-branded product unless otherwise indicated

Part Number	Description	Quantity/Box	Absorption/Box/Roll	Absorption/Pad	Size	Ply	Shipping Weight
235-0847	Absorbent Roll	1 roll	155 L (41 gal)	—	76 cm (30 in) wide 46 m (150 ft) long perforated to 25 cm (10 in) x 38 cm (15 in)	8	14 kg (30.86 lb)
261-0114	Absorbent Mat	1 roll	53.06 L (14 gal)	—	76.2 cm (30 in) wide 15.25 m (50 ft) long	8	5 kg (11.02 lb)
307-9919	Absorbent Pad	100 pads	80 L (21 gal)	798 ml (27 oz)	38 x 48 cm (15 x 19 in)	3	8 kg (17.64 lb)
307-9920	Absorbent Pad	100 pads	91 L (24 gal)	917 ml (31 oz)	38 x 51 cm (15 x 20 in)	8	9 kg (19.84 lb)

Absorbents and Spill Kits — Absorbents

Heavyweight Absorbent Material for Most Oil, Water-Based Fluids and Chemicals (Cont'd.)

Part Number	Description	Quantity/Box	Absorption/Box/Roll	Absorption/Pad	Size	Ply	Shipping Weight
307-9922	Absorbent Pad	100 pads	80 L (21 gal)	798 ml (27 oz)	38 x 48 cm (15 x 19 in)	3	8 kg (17.64 lb)
307-9925	Absorbent Roll	1 roll	163 L (43 gal)	–	76 cm (30 in) wide 46 m (150 ft) long perforated every 25 cm (10 in)	3	15 kg (33.07 lb)
307-9927	Absorbent Roll	1 roll	163 L (43 gal)	–	76 cm (30 in) wide 46 m (150 ft) long	3	15 kg (33.07 lb)

Rip & Fit Absorbent Mat - 385-5560



Warranty: Manufacturer's

- Absorbs large amounts of coolant, oil, solvents, and water, 7.8 gallons (29.5 L)
- Heavy-weight and durable
- Perforations every 10" lengthwise and every 3.75" widthwise to help you easily fit the mat into the shape of your workspace
- 60' L x 15" W fitted into dispenser box
- Dark gray, flame-resistant material
- 50% recycled material
- Refill item for Spill Response Kit, 254-3770

Part Number	Description	Absorption	Dimensions	Shipping Weight
385-5560	Absorbent Roll with length - and widthwise perforations	29.5 L (7.8 gal)	15 in (38 cm) wide x 60 ft (18 cm) long	6.9 lbs (3.1 kg)

High-Visibility Absorbent Mat



Warranty: Manufacturer's

- Absorbs oils, coolants, solvents and water
- Ideal for any leak-, spill-, or drip-prone areas
- Absorbs a wide range of chemicals without degrading or causing a dangerous chemical reaction
- High-visibility yellow color alerts workers to potential dangers where work or repairs are taking place
- Flame-resistant - safe for spark-prone areas such as welding robots
- Comes with a variety of socks and pillows along with a roll of universal mat
- Low profile — slides into hard-to-reach areas
- Supplier-branded product

Part Number	Absorbent Capacity	Length	Width	Weight	Material	Ply
261-0115	125 L (33 gal) per bag	46 m (151 ft)	61 cm (24 in)	11 kg (24 lb)	100% polypropylene	8

Absorbents and Spill Kits — Absorbents

Oil-Only Absorbent Material



Warranty: Manufacturer's

- Heavyweight, white, absorbent material used for spill cleanup and everyday maintenance absorption of non-flammable petroleum products and petroleum-based fluids, such as oil, gasoline, kerosene, diesel fuel, solvents, etc.
- Absorbs petroleum-based fluids only—ideal for situations where water absorption is not necessary
- Roll material works great for factory floors saturated with oils or other petroleum-based fluids
- Less expensive than a universal absorbent (ideal for oil-only spills or drips)
- Material will not degrade or have a chemical reaction to petroleum-based fluids
- Absorbs 10 times its weight, reducing material purchase and disposal costs
- Dimple design helps absorb more liquid in less time (material retains liquid even when fully saturated)
- Roll material cuts easily with scissors or razor knife — easily shaped to fit virtually any area
- Material: 100% polypropylene
- Multiple layers are held together with thermal bond points for added strength and durability—will not fall apart or leave behind residue, even when fully saturated
- Material can be incinerated with less than 0.1% ash while producing 21,000 Btu/lb
- Meets OSHA regulation 29 CFR 1910.22(a)(2) for dry and clean workplace floors
- Material Safety Data Sheets (MSDS) available
- Supplier-branded product unless otherwise indicated

Part Number	Description	Quantity/Box	Absorption/Box/Roll	Absorption/Pad	Size	Shipping Weight	Ply	Color
235-0850	Oil-Only Absorbent Roll	1 roll	155 L (41 gal)	—	76 cm (30 in) wide 46 m (150 ft) long	14 kg (30.86 lb)	8	White
307-9921	Oil-Only Absorbent Pad	50 pads	45 L (12 gal)	917 ml (31 oz)	38 x 51 cm (15 x 20 in)	4 kg (8.82 lb)	8	White
307-9923	Oil-Only Absorbent Pad	100 pads	76 L (20 gal)	739 ml (25 oz)	38 x 48 cm (15 x 19 in)	8 kg (17.64 lb)	3	White
307-9924	Oil-Only Absorbent Roll	1 roll	151 L (40 gal)	—	76 cm (30 in) wide 46 m (150 ft) long	15 kg (33.07 lb)	3	White
307-9926	Oil-Only Absorbent Roll	1 roll	151 L (40 gal)	—	76 cm (30 in) wide 46 m (150 ft) long	15 kg (33.07 lb)	3	White
307-9928	Oil-Only Absorbent Pad	100 pads	76 L (20 gal)	739 ml (25 oz)	38 x 48 cm (15 x 19 in)	8 kg (17.64 lb)	3	White

Absorbents and Spill Kits — Absorbents

Lightweight Absorbent Roll

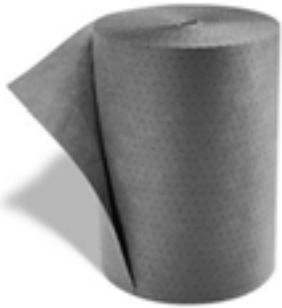

Warranty: Manufacturer's

- Lightweight, gray, absorbent mat designed to cover areas prone to overspray and spills, leaving a cleaner, safer work area
- Ideal for light machine overspray and small, annoying leaks of oils, coolants, solvents, and water
- Great for day-to-day housekeeping and repair work
- Cross roll perforations — easily and quickly tear to any size sheet, as small as 25 x 61 cm (10 x 24 in)
- Works well in narrow walkways
- Multiple layers are held together with thermal bond points for added strength and durability—will not fall apart or leave behind residue
- Absorbs 10 times its weight, reducing purchase and disposal costs
- Dark gray color hides dirt and grime
- Dimple design absorbs more liquid in less time and greater liquid retention holds liquid even when roll is saturated
- Meets OSHA regulation 29 CFR 1910.22(a)(2) for dry and clean workplace floors
- Material Safety Data Sheets (MSDS) available
- Supplier-branded product

Part Number	Quantity/Box	Absorption/Box	Size	Material	Ply	Shipping Weight
235-0849	1 roll	125 L (33 gal)	61 cm (24 in) wide by 91 M (300 ft) long	100% polypropylene	8	11 kg (24.25 lb)

Floor Dry - 4C-5751



Warranty: Cat Standard Warranty, 6 Months

- Diatomaceous Earth Absorbent
- Cleans spills with no residue

Part Number	Description
4C-5751	Floor Dry

Sorbent Spill Kits



Warranty: Cat Standard Warranty, 6 Months

- Most versatile spill kit on today's market
- Chemical Sorbent Folded Spill Kit is a non-selective sorbent which will "sorb" most aggressive chemicals
- 170-8604 fits into small places where accessibility is important; unique construction and compressibility allows storage behind or under seats and/or lab benches where other spill kits will not fit
- 170-8605 is packaged in a 20 gallon drum and can be placed in key locations throughout a facility
- Most complete spill kit in a roll (material can be used as a pillow, pad, roll, or boom)
- Scrim coating on one side increases strength and eliminates linting
- Each kit contains a containment bag and tie
- Molded handles makes transportation easier

170-8604 Spill Kit, 5 Gallon

- Absorb 5 gallons of petroleum-based fluid
- Roll of folded sorbent, 13 x 66 cm (5 x 26 in); fully opened 48 x 66 cm (19 x 26 in); Qty 1
- Disposal bag and tie, Qty 1

170-8605 Spill Kit, 31 Gallon

- Absorb 31 gallons of petroleum-based fluid
- 20 gallon drum with lid and plastic closure ring, Qty 1
- Roll of folded sorbent, 13 x 127 cm (5 x 50 in); fully opened, 48 x 127 cm (19 x 50 in), Qty 2
- Sorbent pads, 43 x 48 cm (17 x 19 in), Qty 30
- Disposal bags and ties, Qty 3

Part Number	Description	Size
170-8604	Sorbent Spill Kit	5 gal
170-8605	Sorbent Spill Kit	31 gal

Absorbents and Spill Kits — Spill Kits

Small Spill Response Bag



Warranty: Manufacturer's

- Highly-visible wall mounted bag
- Absorbs oils, coolants, solvents, and water
- Can absorb up to 38 liters (10 gallons)
- Water resistant bag with hook and loop closure opens and closes easily
- Compact size — can be mounted throughout the shop where spills are most likely to occur
- Weight: 6.4 kg (14 lbs)
- Helps to comply with 40 CFR 263:30 (a)
- Material Safety Data Sheets (MSDS) available
- Supplier-branded product

Part Number	Description	Weight	Size	Qty.
254-3767	Small Spill Response Bag	6.4 kg (14.11 lb)	—	—
Consists of:				
235-0844	Absorbent sock	—	8 cm x 122 cm (3 in x 48 in)	4
235-0848 ⁽¹⁾	Universal mat pads	—	51 cm x 41 cm (20 in x 16 in)	50

Small Spill Response Cart



Warranty: Manufacturer's

- Absorbs oils, coolant, solvents, and water
- Ideal for spill-prone areas
- Comes with a variety of socks, mat pads, pillows, and wipers
- Products in cart can absorb up to 59 liters (15.5 gallons)
- Eight-inch rubber wheels and handles on both top and bottom for carrying
- Cleanup instructions on cart door
- Cart can be locked for security
- Helps to comply with 40 CFR 112.7(c) (1) (vii) where absorbents can be used to control oil discharges
- Material Safety Data Sheets (MSDS) available
- Supplier-branded product

Consist	Qty.	Reorder Part No.
Absorbent sock, 8 cm x 122 cm (3 in x 48 in)	3	235-0844
Absorbent sock, 8 cm x 250 cm (3 in x 10 ft)	2	254-3969
Universal mat pads, 38 cm x 22 cm (15 in x 8.5 in)	52	307-9919
Absorbent pillows, 25 cm x 25 cm (10 in x 10 in)	10	235-0845
Wipers, 33 cm x 30 cm (13 in x 12 in)	56	
Disposal bags and ties	5	

¹ Not available for individual sale

Absorbents and Spill Kits — Spill Kits

Small Spill Response Cart (Cont'd.)

Consist	Qty.	Reorder Part No.
Nitrile gloves	1	4C-5522, 4C-5523, or 4C-5526
Safety goggles	1	233-8583
Disposable boots	1	
Repair putty, 178 mm (7 in) tube	2	
Emergency response guidebook	1	
Instruction Manual	1	

Part Number	Description	Weight
254-3768	Small Spill Response Cart	29.5 kg (65.04 lb)

Small Spill Response Cart



Warranty: Manufacturer's

- Absorbs oils, coolant, solvents, and water
- Ideal for spill-prone areas
- Comes with a variety of socks and pillows along with a roll of universal mat
- Products in cart can absorb up to 53 liters (14 gallons)
- Eight-inch rubber wheels on board and handles on both top and bottom
- Cleanup instructions on cart door
- Shelves and compartments inside cart for easy organization
- Cart can be locked for security
- Helps to comply with 40 CFR 112.7(c) (1) (vii) where absorbents can be used to control oil discharges
- Material Safety Data Sheets (MSDS) available
- Supplier-branded product

Consist	Qty.	Reorder Part No.
Absorbent socks, 8 cm x 122 cm (3 in x 48 in)	5	235-0844
Universal mat pads, 38 cm x 18 m (15 in x 60 ft)	1	
Absorbent pillows, 25 cm x 25 cm (10 in x 10 in)	4	235-0845
Disposable bags and ties	5	
Nitrile gloves	1	4C-5522, 4C-5523, or 4C-5526
Safety goggles	1	233-8583
Repair putty, 178 mm (7 in) tube	1	
"When the Spill Strikes" poster	1	

Part Number	Description	Weight
254-3770	Small Spill Response Cart	18 kg (39.68 lb)

Absorbents and Spill Kits — Spill Kits

Large Spill Response Kit



- Absorbs oils, coolants, solvents, and water
- Comes with a variety of socks, mats, pillows, and loose absorbents
- Products in cart can absorb up to 144 liters (38 gallons)
- Polyethylene container with hinged lid stores and protects absorbents from moisture, dirt, and damage
- Equipped with eight-inch rubber wheels and built-in handles for easy mobility in tight spaces
- Helps to comply with 40 CFR 112.7(c) (1) (vii) where absorbents can be used to control oil discharges
- Material Safety Data Sheets (MSDS) available
- Supplier-branded product

Consist	Qty.	Reorder Part No.
Absorbent sock, 8 cm x 122 cm (3 in x 48 in)	4	235-0844
Absorbent sock, 8 cm x 250 cm (3 in x 10 ft)	1	254-3969
Absorbent pillows, 53 cm x 43 cm (21 in x 17 in)	2	235-0845 ⁽²⁾
Universal mat pads, 51 cm x 41 cm (20 in x 16 in)	50	
Disposal bags and ties	5	
Shop floor sweep material	1	
Loose absorbent material	2	
Tamper-proof labels	6	
Instructions	1	

Part Number	Description	Weight
254-3769	Large Spill Response Kit	48.5

² Equivalent - not an exact replacement

473-6461 Grippy Absorbent Traffic Floor Mat



Warranty: Caterpillar Standard Warranty, Six Months

- Absorbs and retains water, oils, grease, coolants, solvents, etc., while preventing dirt, sand, and liquids from being tracked off onto clean floors
- Demonstrated to reduce slips and falls by as much as 90%
- Grippy backing holds mat in place but peels up easily without residue
- Heat-fuse and needle-punched for durability
- Holds up to heavy traffic, including power trucks
- Liquidproof barrier layer prevents seepage through the mat
- Dark color hides grime allowing longer use
- Absorbs up to 13 gal (49 L)
- Medium weight
- 36 in x 100 ft (914 mm x 30 m)
- 24 pounds (11 kg)

Rugs

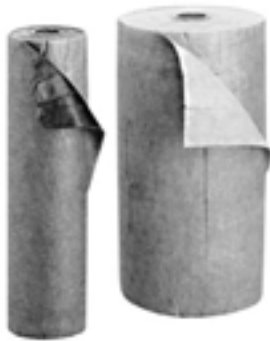

Warranty: Cat Standard Warranty, 6 Months

- Keep shop floors cleaner and safer
- Absorb most shop fluids and oils
- Tough and tear resistant—won't break down
- Durable enough to withstand heavy traffic
- Coated rug has a poly-backed coating to provide extra protection to shop floors

Part Number	Description	Size	Absorbent Capacity
159-5155	Rug	91 cm x 91.5 m (36 in x 300 ft)	121 L (32 gal) per roll
159-5160	Rug (Coated)	91 cm x 30 m (36 in x 100 ft)	40 L (10.5 gal) per roll

WorkSafe Floor Mat

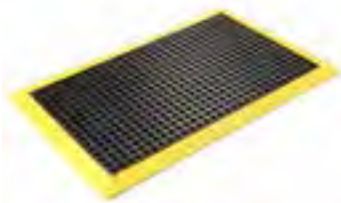

Warranty: Cat Standard Warranty, 6 Months

- Holes trap dirt and small debris and are easy to clean
- Black with orange beveled border
- Border can be removed and reattached after cutting mat to any size
- 7/8 in (22.2 mm) thick

Part Number	Size
4C-8099	2 ft x 3 ft (61 cm x 91 cm)
4C-8101	3 ft x 5 ft (91 cm x 152 cm)

Floor Mats

Rejuvenator Connect Modular Floor Mat



Warranty: Cat Standard Warranty, 6 Months

- Interlocks on all four sides
- Customizable down to 3 x 3 ft (0.914 x 0.914 m) squares
- Resists a wide variety of chemicals of fluids
- Border ramps are yellow for safety
- Urethane sponge material with tough outer skin
- 5/8" in (1.59 cm) thick

Part Number	Description	Size
384-8706	Center Segment	36 in x 36 in (91.4 cm x 91.4 cm)
385-8474	Male Ramp	2 in x 39 in (5.1 cm x 99 cm)

Weldsafe Floor Mat



Warranty: Cat Standard Warranty, 6 Months

- Designed specifically for welding/grinding stations
- Top surface has melting point of over 500°F (260°C)
- Beveled edges
- Black
- 9/16 in (1.4 cm) thick

Part Number	Size
385-8475	36 in x 60 in (91 cm x 152 cm)

Clean Walk Mats

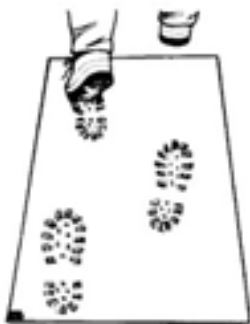

Warranty: Cat Standard Warranty, 6 Months

SMCS Code 7951-580

- 30 peelable layers, providing a fresh cleaning surface with each exposed layer
- Removes dirt and contamination from shoes, wheels, and other passing objects – keeps dirt and grease from being tracked into office area
- Inexpensive way to keep carpets and office areas clean
- Low profile – only 0.055 in (1.4 mm) thick

Part Number	Size
138-3856	635 mm x 1143 mm (25 in x 45 in)

General Purpose Masking Tape



Warranty: Cat Standard Warranty, 6 Months

- Can be used for holding, bundling, sealing, tabbing non-critical masking and many other miscellaneous applications where an economical grade of paper tape is needed

Part Number	Size in 55 m (60 Yd) Rolls	Rolls/Case
4C-6571	25.4 mm (1 in)	36
4C-6572	50.8 mm (2 in)	24
4C-6573	76.2 mm (3 in)	12

Masking Paper



Warranty: Cat Standard Warranty, 6 Months

- Specially formulated, high density masking paper that helps reduce labor cost, decreases rework, and minimizes cleanup
- Its unique, virtually "pinhole-free" construction delivers exceptional paint and solvent resistance to help eliminate bleed-through
- For protection, each roll is individually wrapped
- The paper's balanced construction offers conformability, strength, and easy handling

Part Number	Description	Size	Rolls/Case
1U-9732	Masking Paper	304.8 mm x 304.8 m (12 in x 1000 ft)	3
1U-9733	Masking Paper	609.6 mm x 304.8 m (24 in x 1000 ft)	1
1U-9734	Masking Paper	914.4 mm x 304.8 m (36 in x 1000 ft)	1

Masking Tape



Warranty: Cat Standard Warranty, 6 Months

- Six sizes available—13 mm (1/2 in) to 76.2 mm (3 in) wide, 60 yd. roll
- Clean removal—less adhesive transfer reduces residue which can stick to work surface
- Sharp paint edge—thin, smooth backing gives a superior, straight paint line with no jagged edges
- One-piece removal—balanced construction allows for one-piece removal
- Heat resistant—will generally function well in conditions up to 93° C (200° F)

Part Number	Size in 55 m (60 Yd) Rolls	Rolls/Case
1U-6705	12.7 mm (1/2 in)	72
1U-6706	19.0 mm (3/4 in)	48
1U-6707	25.4 mm (1 in)	36
1U-6708	50.8 mm (2 in)	24

Tape

Masking Tape (Cont'd.)

Part Number	Size in 55 m (60 Yd) Rolls	Rolls/Case
1U-6709	63.5 mm (2 1/2 in)	12
1U-6710	76.2 mm (3 in)	12

Label Protection Tape

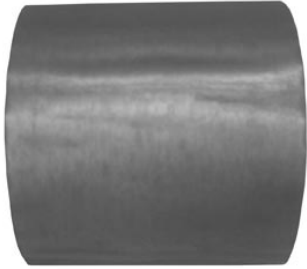

Warranty: Cat Standard Warranty, 6 Months

- Used for covering address labels, packing lists, and sales slips when protection against rough handling is needed
- Aggressive water-based acrylic adhesive
- Resistant to UV light and chemicals
- Adhesion to steel: 17.9 N/cm (16 oz/in)
- Tensile strength: 0.32 kg/mm (18 lb/in)
- Thickness: 0.04 mm (1.6 mils)
- Material: polypropylene

Part Number	Size	Rolls/Case
263-0881	96.01 mm x 659.9 m (3.78 in x 216.5 feet) roll	18

Filament Tape



Warranty: Cat Standard Warranty, 6 Months

- Stain resistant and transparent with reinforced continuous glass yarn filaments
- Used for closure and reinforcement of corrugated fiberboard boxes and performs well in holding, reinforcing, combining, bundling, and unitizing applications

Part Number	Size	Package Quantity
4C-4094	19 mm (3/4 in) x 55 m (60 yd) roll	48

Filament Tape



Warranty: Cat Standard Warranty, 6 Months

- Fiberglass reinforced tape excellent for light-duty applications such as strapping, palletizing, and packaging
- Adhesion to steel: 8.5 g/mm (78 oz/in)
- Elongation: 8%
- Tack: 12.7 cm (5 in)
- Tensile strength: 1.71 kg/mm (95.6 lb/in)
- Thickness: 0.099 mm (3.9 mils)

Filament Tape (Cont'd.)

Part Number	Size	Rolls/Case
263-0883	8.89 mm x 548.64 m (0.35 in x 180 feet)	96

Transparent Tape



Warranty: Cat Standard Warranty, 6 Months

- Good for general purpose packaging needs
- Was developed primarily for single strip closure of regular slotted containers
- Has very good resistance to edge tear and splitting due to shock from impact
- Adhesive sticks at a touch to fiberboard

Part Number	Size	Package Quantity
4C-4095	48 mm (2 in) x 100 m	36

Double-faced Tape



Warranty: Cat Standard Warranty, 6 Months

- Multipurpose tape for general mounting and holding
- Can be used to reattach interior cab material or head liners, sound proofing material, etc.
- Extremely aggressive adhesive
- Silicone-coated polyethylene release liner makes unwinding easy
- Peels clean leaving minimum residue
- Adhesion to steel: 44 g/mm (40 oz/in)
- Tack: 5.1 cm (2 in)
- Tensile strength: 0.36 kg/mm (20 lb/in)
- Thickness: 0.28 mm (11 mils)

Part Number	Size	Rolls/Case
263-0877	51 mm x 22.9 m (2 in x 25 yards) roll	24

Tape

Thread Seal Tape



Warranty: Cat Standard Warranty, 6 Months

- Multipurpose non-adhesive thread seal tape used for many maintenance applications
- Polytetrafluoroethylene (PTFE) self lubricates joints for a leak-proof seal
- Easy to assemble and disassemble threaded joints when tape is applied
- Thickness: 0.09 mm (3.5 mils)
- Material: polytetrafluoroethylene

Part Number	Size	Rolls/Case	Color
263-0879	13 mm x 76.2 m (0.5 in x 250 feet) roll	200	White

Duct Tape



Warranty: Cat Standard Warranty, 6 Months

- Use this silver, polyethylene-coated, cloth tape for sealing and/or waterproofing applications
- Has an extremely tough rubber adhesive

Part Number	Size	Package Quantity
190-9792	51 mm (2 in) wide and 55 m (60 yds) long	1

High Performance Duct Tape



Warranty: Cat Standard Warranty, 6 Months

- Use this olive drab, polyethylene-coated, cloth tape for sealing and/or waterproofing applications
- Conforms to mil spec PPP-T-60D
- Rubber adhesive adheres securely
- Thickness: 12 mils
- Tensile strength: 42 lbs per inch

Part Number	Size	Package Quantity
9U-5922	51 mm wide x 55 mm long (2 in wide x 60 yd long)	1

Electrical Tape



Warranty: Cat Standard Warranty, 6 Months

- Premium quality vinyl tape with many electrical insulation applications

Part Number	Size	Package Quantity
1P-0810	19 mm x 20.12 m long (3/4 in wide x 66 ft long)	10

Electrical Tape



Warranty: Cat Standard Warranty, 6 Months

- Quality, black, vinyl tape with excellent electrical insulation properties

Part Number	Size	Package Quantity
235-8598	19 mm x 18.3 m long (3/4 in wide x 60 ft long)	10

Aluminum Tape



Warranty: Cat Standard Warranty, 6 Months

- A variety of sizes of aluminum tape that can be used to seal openings of various machine components such as cylinder assembly tubes during shipping and storage
- 3.5 Mil thick
- Tough but flexible
- Hi-tack
- Waterproof

Part Number	Description	Size
9U-6910	Aluminum Tape	63.5 mm x 45.7 m (2 1/2 in x 50 yds)
9U-6911	Aluminum Tape	101.6 mm x 45.7 m (4 in x 50 yds)
9U-6912	Aluminum Tape	152.4 mm x 45.7 m (6 in x 50 yds)
9U-7042	Aluminum Tape	304.8 mm x 45.7 m (12 in x 50 yds)

Tape

Box Sealing Tape Dispenser



Warranty: Cat Standard Warranty, 6 Months

- Provides quick, easy method for dispensing 4C-4095 Transparent Tape, or any other film-backed box sealing tape directly from the roll
- Hand-held and portable—excellent on center seam sealing of regular slotted boxes
- Sturdy, durable, easy to load and operate; handles tape widths from 38 mm (1 1/2 in) to 51 mm (2 in)

Part Number	Package Quantity
4C-4099	1

Filament Tape Dispenser



Warranty: Cat Standard Warranty, 6 Months

- Fast and economical clips of 4C-4094 Filament Tape can be applied
- Dispenser cuts and buffs tape with one-hand motion
- Features hand brake in the core that allows operator to adjust tension for tighter box reinforcement and bundling applications
- High impact plastic and one piece construction makes the dispenser very durable
- Handles filament tapes up to 19 mm (3/4 in) wide

Part Number	Package Quantity
4C-4100	1

Rubber Mastic Tape

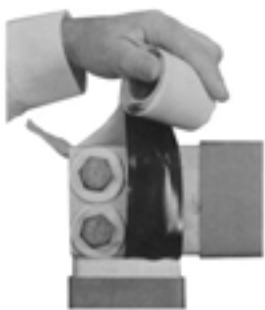

Warranty: Cat Standard Warranty, 6 Months

- Great for quick buildup for moisture seal, for insulation, and for cushion on cable harness and wires
- Sticks fast, seals fast and stays tight
- Molds easily around irregular surfaces while holding its position through a range of temperatures

Part Number	Size	Package Quantity
4C-6392	51 mm (2 in) wide X 1.7 mm (.065 in) thick by 3 m (10 ft) long rolls	1 Roll

Handwrappers



Warranty: Cat Standard Warranty, 6 Months

- Full rolls to 558.8 mm (22 in) wide
- Fits 76.2 mm (3 in) core
- Heavy duty mast
- Ball bearings
- Adjustable tension
- Ring rotates freely
- Foam grip

Part Number	Description	Use
4C-4776	Handwrapper	all 279 mm (11 in), 400 mm (15.75 in), 457 mm (18 in) films with 76 mm (3 in) cores
4C-4777	Handwrapper	all 279 mm (11 in), 692 mm (27.25 in), 457 m (18 in) films with 57 mm (2.25 in) and 76 mm (3 in) cores

Adjustable Stretch Band-it Tool



Warranty: Cat Standard Warranty, 6 Months

- Fully mechanical
- Adjustable stretch control
- No spare parts—no parts to replace or wear out
- Use with 4C-4880 Film

Part Number	Description
4C-4779	Adjustable Stretch Band-it Tool

Stretch Band-it Tool



Warranty: Cat Standard Warranty, 6 Months

- "Hand Squeeze" control
- No assembly, no maintenance, no additional adhesives
- Use with 4C-4880 Film

Part Number	Description
4C-4780	Stretch Band-it Tool

Packing Supplies and Equipment

Stretch Band-it Stand



Warranty: Cat Standard Warranty, 6 Months

- Portable
- Mounts on any table surface
- Accommodates up to 16 kg (35 lbs)
- Adjustable zinc-plated support
- Allows wrapping of smaller items using 4C-4880 Film and 4C-4779 or 4C-4780 Stretch Band-it Tools

Part Number	Description
4C-4781	Stretch Band-it Stand

Heavy-Duty Master Wrap Film



Warranty: Cat Standard Warranty, 6 Months

- Holds anything, any shape, anywhere
- Applicator packed in all cases
- Heavy-duty gauge

Part Number	Rolls/Case	Film Gauge	Film Width	Roll Length	Film Color
4C-4880	12	135	127 mm (5 in)	198 m (649.60 ft)	Blue

Stretch Film



Warranty: Cat Standard Warranty, 6 Months

- Revolutionary performance standard—one of the strongest films in the industry
- Cast formula
- Stiff high force
- No neck-down films
- Has highest holding-force-to-load possible without breaks
- Visually able to see through to wrapped product

Part Number	Rolls/Case	Film Width	Roll Length	Film Color
291-6710	4	457.2 mm (18 in)	457 m (1,499.34 ft)	Clear
291-6711	4	279.4 mm (11 in)	457 m (1,499.34 ft)	Clear

Hand Wrap Standard-Duty Stretch Film



Warranty: Cat Standard Warranty, 6 Months

- Convenient stretch film system
- Extra wide—508 mm (20 in) compared to 457.2 mm (18 in)
- Standard-duty gauge

Part Number	Rolls/Case	Film Width	Roll Length	Film Color
293-2978	4	508 mm (20 in)	305 m (1,000.65 ft)	Clear

Heat Shrink Bags



Warranty: Cat Standard Warranty, 6 Months

- Strong durable plastic excellent for pallet unitization and load retention
- Ensures product will arrive at destination clean and undamaged
- To determine the size of opening for gusseted bags, add the width and depth
- UVI protection will protect bag from sun damage in outdoor storage.

Part Number	Width x Depth x Height	Thickness	Qty.
Gusseted Heat Shrink Bag			
270-5329	800 x 495 x 710 mm (31.5 x 19.5 x 28 in)	5 mil	135 bags/roll
270-5331	1257 x 495 x 1370 mm (49.5 x 19.5 x 54 in)	5 mil	65 bags/roll
Flat Heat Shrink Bag			
270-5332	2438 x 1829 mm (96 x 72 in)	5 mil	35 bags/roll
270-5333	3810 x 2970 mm (150 x 117 in)	5 mil	15 bags/roll

Cardboard Boxes with Cat Logo



Warranty: Cat Standard Warranty, 6 Months

- Material: corrugated paper

Part Number	Length x Width x Depth	Edge Crush Number (ECT)	Qty.
270-5348	213 x 213 x 210 mm (8.4 x 8.4 x 8.3 in)	32 lb	25 per package
270-5349	254 x 203 x 170.8 mm (10 x 8 x 7 in)	32 lb	25 per package
270-5350	300 x 300 x 190 mm (11.8 x 11.8 x 7.5 in)	32 lb	20 per package
270-5351	318 x 315 x 224 mm (12.5 x 12.4 x 8.8 in)	32 lb	25 per package
270-5352	356 x 356 x 229 mm (14 x 14 x 9 in)	32 lb	10 per package
270-5353	648 x 648 x 503 mm (25.5 x 25.5 x 19.8 in)	—	5 per package

Packing Supplies and Equipment

Heat Shrink Sheeting



Warranty: Cat Standard Warranty, 6 Months

- Strong durable plastic excellent for pallet unitization and load retention
- Ensures product will arrive at destination clean and undamaged
- 5% UVI protection will protect bag from sun damage in outdoor storage

Part Number	Roll Size	Thickness	Color	Qty.
270-5334	5.5 x 61 m (18 x 200 ft)	7 mil	white	1 roll
270-5335	914 mm x 198 m (36 in x 650 ft)	5 mil	clear	1 roll
270-5336	1.37 x 198 m (54 in x 650 ft)	5 mil	clear	1 roll

Maintenance Products Box



Warranty: Cat Standard Warranty, 6 Months

The Maintenance Products box preventive maintenance items, such as filters and grease, for machine service intervals. Designed to support dealer promotional campaigns and over-the-counter part sales; the carton assembles easily and has a convenient carrying handle.

- Made of recyclable heavy duty cardboard
- Practical handle for easy transport
- Includes blank lines for recording box contents
- Simple assembly
- Bundled unassembled in quantities of 20
- Dimensions: 16" x 14" x 12"

Part Number	Description	Qty.
390-3319	483 X 457 X 381 mm (19 X 18 X 15 in)	10 per bundle
332-1471	406 X 356 X 305 mm (16 X 14 X 12 in)	20 per bundle

Plastic Bags with Cat Logo



Warranty: Cat Standard Warranty, 6 Months

- Two-color Cat logo on front, clear on the back
- Great for parts storage and shipping
- Exceptional strength
- Material: linear low density polyethylene (LLDPE)

Part Number	Bag Size	Thickness	Qty.
270-5337	30.48 cm x 45.72 cm (12 x 18 in)	1.75 ml	1000 bags/carton
270-5338	45.72 cm x 61 cm (18 x 24 in)	1.75 ml	500 bags/carton

Packing Supplies and Equipment

High Performance Steel Strapping



Warranty: Cat Standard Warranty, 6 Months

- Great for stabilizing heavy loads during transportation
- Break strength: 972.2 kg (2150 lbs)

Part Number	Size	Thickness
270-5343	19 mm x 624.8 m (3/4 in x 2050 ft)	0.5 mm (0.02 in)

Strapping Seals



Warranty: Cat Standard Warranty, 6 Months

- Easy to use strapping buckles
- Holds tension strong for nylon poly strapping
- Used with 270-5345 Nylon Cord Strapping, 12.7 mm (1/2 in) wide

Part Number	Size	Qty.
270-5344	12.7 mm (1/2 in)	1000 buckles per carton

High Performance Nylon Cord Strapping



Warranty: Cat Standard Warranty, 6 Months

- Economical alternative to steel strapping
- Easy to use on a wide range of products
- Used with 270-5344 Strapping Seals, 12.7 mm (1/2 in)
- Breaking strength: 272.1 kg (600 lbs)

Part Number	Size	Color	Qty.
270-5345	12.7 mm x 1188.7 m (1/2 in x 3900 ft)	White	4 rolls per box

Packing Supplies and Equipment

Shrinkfast Shrink Gun



Warranty: Cat Standard Warranty, 6 Months

- Portable — 3.5 lbs
- Fast — shrinkwrap a 1016 mm x 1219.2 mm x 1524 mm (40 in x 48 in x 60 in) pallet in less than two minutes
- UL listed
- Fast shrinkwrapping — the shrink gun is faster and holds more securely than either stretch-wrapping or banding
- Versatile — the shrink gun can be used on machinery, bagged products, boxes, pallets, construction materials, chemicals, petroleum containers, metals cabinets, and shelving
- Safe — operates with a safety latch trigger to prevent unintentional firing and shuts off automatically when put down
- Product support — repair parts are available through the Caterpillar Parts Distribution system

Part Number	Description	Heat Capacity	Propane Usage	Operating Pressure	Air Consumption
4C-4515	Shrinkfast Shrink Gun	—	2.6 kg/hr (5.71 lb/hr)	22.00 psi	21 CFM
Repair Parts (Warranty: Six Months)					
4C-4511	Fuel Line	—	—	—	—
4C-4512	Valve Assembly	—	—	—	—
4C-4513	Hose Adapter	—	—	—	—
4C-4514	Spark Plug	—	—	—	—
4C-4516	Regulator Assembly	—	—	—	—
4C-4517	Gauge (Pressure)	—	—	—	—
4C-4518	U.L. Guard	—	—	—	—

Poly Coat Paper



Warranty: Cat Standard Warranty, 6 Months

- Used for protecting metal parts and tools, metal sheeting interleaving, protecting goods on pallets from moisture and debris
- Fifty pound virgin kraft paper with 10 pound polycoating
- Heavy duty protection from water, grease, and oil
- Fits standard dispenser — 3-inch core with plugs that reduce it to 1 inch

Part Number	Description	Size
263-0891	Poly Coat Paper	914.4 mm x 274.3 m (36 in x 900 feet) roll

Electric Tie Strap Tightener

Warranty: Manufacturer's

- Tightens cable ties and cuts off excess when preset tension is attained
- Used with straps, harnesses, and hoses
- Has a comfortable grip and handle for all hand sizes
- Tightens up to 12.7 mm (1/2 in) wide straps
- Weight: 454 g (16 oz)

Part Number	Description
4C-5877	Electric Tie Strap Tightener

Label Maker Kit

Warranty: Cat Standard Warranty, 6 Months



- Create metal labels that stand up to harsh weather, temperature and corrosion
- For tagging hoses, castings, engine components, pipes, etc.
- Heavy-duty cast aluminum body construction
- Built-in hole punch
- Front scissors cut-off—cuts tape exactly where required
- Tape advance and rewind control
- Wheel characters-selection window helps reduce embossing errors
- Also embosses 12.6 mm (1/2 in) vinyl tape
- 306-9601 tags will fit hose up to 3.25 inches in diameter

Part Number	Description	Size	Qty.
9U-7918	Label Maker Kit	—	—
9U-7918 Label Maker Kit			
9U-7920	Aluminum Tape Roll, no adhesive	12.7 mm (1/2 in) x 4.88 m (16 ft) x 0.1524 mm (0.006 in thick)	10 per box
Optional			
306-9601	Aluminum Hose Tag ⁽¹⁾	12.7 mm (1/2 in) x 279.4 mm (11 in) x .305 mm (.012 in) thick	500 per box
9U-7920	Aluminum Tape Roll, no adhesive	12.7 mm (1/2 in) x 4.88 m (16 ft) x 0.1524 mm (0.006 in thick)	10 per box
9U-7921	Aluminum Tape Roll, with adhesive	12.6 mm (1/2 in) x 3.66 m (12 ft) x 0.33 mm (0.13 in thick)	10 per box
9U-7922	Stainless Steel Tape Roll, no adhesive	12.7 mm (1/2 in) x 6.41 m (21 ft) x 0.127 mm (.005 in thick)	10 per box

1 Warranty: Six Months

Miscellaneous — Padlocks

Combination Padlock - 285-1145



Warranty: Manufacturer, Two Years

- Cat part number engraved on side of padlock

Part Number	Combination Type	Lock Mechanism	Width	Shackle Diameter	Horizontal Shackle Clearance	Vertical Shackle Clearance
285-1145	Resettable	4-digit dialing	50.8 mm (2 in)	7.9 mm (5/16 in)	25.4 mm (1 in)	25.4 mm (1 in)

Combination Padlock - 285-1146



Warranty: Manufacturer, Two Years

- Cat part number engraved on back of padlock

Part Number	Combination Type	Lock Mechanism	Width	Shackle Diameter	Horizontal Shackle Clearance	Vertical Shackle Clearance
285-1146	fixed	3-digit dialing	47.6 mm (1 7/8 in)	7.1 mm (9/32 in)	20.6 mm (13/16 in)	19.0 mm (3/4 in)

High Security Brass Padlock - 285-1147



Warranty: Manufacturer, Two Years

- Lock body and shackle black with Cat logo on both sides of bumper, Cat part number on side of bumper

Part Number	Number of Pin Tumblers	Width	Shackle Diameter	Horizontal Shackle Clearance	Vertical Shackle Clearance
285-1147	5	44.4 mm (1 3/4 in)	7.1 mm (9/32 in)	20.6 mm (13/16 in)	22.3 mm (7/8 in)

High Security Brass Padlock - 285-1148



Warranty: Manufacturer, Two Years

- Lock body and shackle black with Cat logo on both sides of bumper, Cat part number on side of bumper

High Security Brass Padlock - 285-1148 (Cont'd.)

Part Number	Package Quantity	Number of Pin Tumblers	Width	Shackle Diameter	Horizontal Shackle Clearance	Vertical Shackle Clearance
285-1148	2	5	44.4 mm (1 3/4 in)	7.1 mm (9/32 in)	20.6 mm (13/16 in)	22.3 mm (7/8 in)

High Security Brass Padlock - 285-1149



Warranty: Manufacturer, Two Years

- Lock body and shackle black with Cat logo on both sides of bumper, Cat part number on side of bumper

Part Number	Number of Pin Tumblers	Width	Shackle Diameter	Horizontal Shackle Clearance	Vertical Shackle Clearance
285-1149	5	44.4 mm (1 3/4 in)	7.1 mm (9/32 in)	20.6 mm (13/16 in)	63.5 mm (2 1/2 in)

High Security Brass Padlock - 285-1150



Warranty: Manufacturer, Two Years

- Lock body and shackle black with Cat logo on both sides of bumper, Cat part number on side of bumper

Part Number	Package Quantity	Number of Pin Tumblers	Width	Shackle Diameter	Horizontal Shackle Clearance	Vertical Shackle Clearance
285-1150	4	5	44.4 mm (1 3/4 in)	7.1 mm (9/32 in)	20.6 mm (13/16 in)	63.5 mm (2 1/2 in)

Miscellaneous — Ladders

Step Ladders and Shelf Ladders

Warranty: Cat Standard Warranty, 6 Months

Step Ladder



- Fiberglass nonconductive industrial step ladder designed for everyday use
- Extra heavy-duty, 136 kg (300 lb) weight rating
- Thick non-marring rubber tread provides a slip resistant footing
- Wide back braces provide maximum stiffness and discourages unsafe climbing
- Full channel fiberglass rails are covered with a polyester veil for years of service
- Double-rivet step construction with tubular steel rivets for maximum strength
- Nonconductive structural molded top with tool slots is extremely durable (slots help keep tools close at hand)
- Spreader braces are located inside rails to help protect them from getting hooked or damaged in transit
- Reinforced bottom back brace provides additional strength to bottom of ladder

Shelf Ladder



- Aluminum industrial shelf ladder for everyday industrial use
- Extra heavy-duty, 136 kg (300 lb) weight rating
- Steps are level when ladder is set at 72 degrees
- Equipped with thick rubber bumpers extending 152 mm (6.0 in) from top of ladder down side rails
- Two pair of heavy duty steel gussets support bottom step
- Angled feet with thick rubber tread on both legs provide sure footing
- Each step is secured with solid aluminum rivets for maximum strength

Part Number	Description	Height	Step Size	Bottom Width	Approx. Spread	Approx. Weight
263-1022	Shelf Ladder	2.4 m (7.87 ft)	7.6 cm (2.99 in)	38.1 cm (15 1/64 in)	–	7.7 kg (16.98 lb)
263-1030	Step Ladder	1.2 m (3.94 ft)	7.6 cm (2.99 in)	45.7 cm (18 1/64 in)	71 cm (27.95 in)	5.9 kg (13.01 lb)
263-1031	Step Ladder	2.4 m (7.87 ft)	7.6 cm (2.99 in)	61.0 cm (24 1/64 in)	132 cm (51.97 in)	12.2 kg (26.90 lb)

Miscellaneous — Janitorial Products

Brooms

Warranty: Cat Standard Warranty, 6 Months



Push Broom

- 100% Select black tampico
- Clear lacquered half-round hardwood block
- Recommended for dry sweeping semi smooth floors
- Handle not included

Handle

- Selected hardwood with clear lacquered finish
- One end rounded and other end equipped with crimped on metal thread to fit standard floor brush blocks

Whisk Broom

- Made of selected fine broom corn
- Sewn twice for strength
- Plated ring cap

Part Number	Description	Size	Qty.
263-0794	Push Broom	609 mm (24 in) wide	1
263-0796	Broom Handle	23.8 x 1524 mm (15/16 x 60 in)	1

Janitorial Equipment

Warranty: Cat Standard Warranty, 6 Months



Janitorial Bucket

- Side pressure wringer
- 7.6 cm (3 in) casters
- Color: yellow
- Size: (L x W x H) 33 x 33 x 68.6 cm (13 x 13 x 27 in)

Mop Heads

- Lay-flat style
- Screw-type mount
- Use with 264-4364 Mop Handle

Mop Handle

- Lay-flat style
- Screw-type mount
- Metal cap

Part Number	Description	Material	Size	Qty.
264-4360	Janitorial Bucket	rubber	33.1 L (35 qt) capacity	1
264-4361	Rayon Mop Head	4-ply rayon	0.9 kg (32 oz)	1
264-4363	Cotton Mop Head	4-ply cotton	0.68 kg (24 oz)	1
264-4364	Mop Handle	hardwood	152.4 cm (60 in) long	1

Miscellaneous — Janitorial Products

Trash Can or Waste Receptacle Liners



Warranty: Cat Standard Warranty, 6 Months

- Plastic, super durable trash can liners with superior stretch and tear resistance
- Bottom designed for added strength and greater leak resistance

Part Number	Strength	Capacity	Liner Size	Quantity/Roll
263-0885	Medium (10-12 micron)	57 L (15 gal)	60.96 cm x 81.28 cm (24 in x 32 in)	500
263-0886	Heavy (12-14 micron)	125 L (33 gal)	83.82 cm x 99.06 cm (33 in x 39 in)	250
263-0887	Extra-Heavy (15-17 micron)	208 L (55 gal)	91.44 cm x 144.78 cm (36 in x 57 in)	200

Heavy Duty Garbage Bags



Warranty: Cat Standard Warranty, 6 Months

- Made from the highest quality raw materials
- Mineral reinforced to enhance physical properties
- Exceptional strength
- Performance bottom seal resists leakage
- Individually-folded in space-saving packaging

Part Number	Size	Capacity	Color	Qty.
270-5346	1092 x 1193.8 cm (43 x 47 in) 212 L (56 gallon)	22.7 kg (50.04 lb)	HMW-HDPE Gray	100 bags/case

Miscellaneous — Highway Warning Kit

Triangular Highway Warning Kit



Warranty: Cat Standard Warranty, 6 Months

- Three reflective triangles in a sturdy plastic case
- Compact, fold-flat design
- Durable spring steel base
- Complies with Federal Motor Vehicle Safety Standard Number 1
- Great for day or night visibility

Part Number	Description	Case Dimensions	Size	Qty.
262-4862	Triangular Warning Kit	(L x W x H): 45.7 x 13 x 13 cm (18 x 5 x 5 in)	43 cm (17 in)	3 per case

Miscellaneous — Sprayers

Reusable, Bulk-Liquid Sprayers



Warranty: Cat Standard Warranty, 6 Months

- Used to apply oil and water-based bulk chemicals, such as cleaners, degreasers, penetrating oils, solvents, or lubricants
- Compressed air sprayers provide a cost effective, reusable alternative to traditional spray cans (eliminates both storage and disposal concerns)
- Cat compressed air sprayers use a special chemical-resistant internal seal which virtually eliminates seal replacement problems found in standard sprayers
- Eliminate using flammable and/or environmentally dangerous propellants
- Canisters pressurized with compressed air from any standard air compressor
- Both sprayers constructed with metal canisters (steel or brass), brass nozzles, and corrosion resistant internal parts
- Steel canister sprayers are used for oil and solvent-based materials while brass canisters can also be used for water-based materials
- Cannot be used for paint application
- Capacity: 0.9 l (32 oz)

Part Number	Description
231-7015	Steel Canister Sprayer
Service Parts	
231-7016	Adjustable Tube
231-7017	Seal
231-7018	Nozzle

Miscellaneous — Miscellaneous Products

Poly Coat Paper



Warranty: Cat Standard Warranty, 6 Months

- Used for protecting metal parts and tools, metal sheeting interleaving, protecting goods on pallets from moisture and debris
- Fifty pound virgin kraft paper with 10 pound polycoating
- Heavy duty protection from water, grease, and oil
- Fits standard dispenser — 3-inch core with plugs that reduce it to 1 inch

Part Number	Description	Size
263-0891	Poly Coat Paper	914.4 mm x 274.3 m (36 in x 900 feet) roll

Cable Ties and Applicators

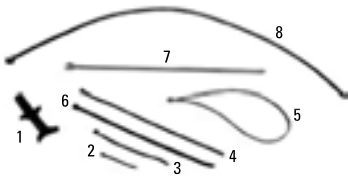

Warranty: Cat Standard Warranty, 6 Months

- Used to secure wires, cables, tubes, etc.

Item	Installer Part Number	For Part Number (below)
1	1U-5228	1S-9593, 8L-8413, 3S-2093, & 6K-0806
1	1U-5227	7K-1181

Item	Part Number	Bundle Diameter Range	Strap Width	Package Quantity	Installer
2	1S-9593	1.5 mm to 15.7 mm (.06 in to .62 in)	2.5 mm (0.10 in)	100	1U-5228
2	8L-8413	1.5 mm to 28.4 mm (.06 in to 1.12 in)	3.8 mm (0.15 in)	200	1U-5228
3	3S-2093	1.5 mm to 44.5 mm (.06 in to 1.75 in)	4.9 mm (0.19 in)	500	1U-5228
4	6K-0806	1.5 mm to 101.6 mm (.06 in to 4.00 in)	4.9 mm (0.19 in)	250	1U-5228
5	034-1432	1.5 mm to 203 mm (.06 in to 8.00 in)	—	1	—
6	7K-1181	4.8 mm to 101.6 mm (.19 in to 4.00 in)	7.9 mm (0.31 in)	100	1U-5227
7	5P-5148	44.5 mm to 120.6 mm (1.75 in to 4.75 in)	12.7 mm (0.50 in)	100	—
8	6V-7555	44.5 mm to 305 mm (1.75 in to 12.00 in)	12.7 mm (0.50 in)	1	—
Not shown	240-1678	12.7 mm to 79.4 mm (0.5 in to 3.125 in)	4.8 mm (0.19 in)	1000	—

Miscellaneous — Miscellaneous Products

Electric Tie Strap Tightener

Warranty: Manufacturer's

- Tightens cable ties and cuts off excess when preset tension is attained
- Used with straps, harnesses, and hoses
- Has a comfortable grip and handle for all hand sizes
- Tightens up to 12.7 mm (1/2 in) wide straps
- Weight: 454 g (16 oz)

Part Number	Description
4C-5877	Electric Tie Strap Tightener

Tyvek Coveralls



Warranty: Cat Standard Warranty, 6 Months

- White coveralls with zipper front
- For general maintenance work, fiberglass handling, spray painting, and sand blasting
- Offers splash protection against many liquids
- Lightweight and soft
- Strong, whether wet or dry
- Resistant to abrasion, tears, and punctures
- 100% Polyethylene construction
- Unaffected by most chemicals
- Blocks out 99.9% of all dry particulate down to 0.5 microns

Part Number	Size	Qty.
267-8539	Large	25
267-8540	Medium	25
267-8541	Small	25
267-8542	X Large	25
267-8543	XX Large	25
267-8544	XXX Large	25
267-8545	XXXX Large	25

Miscellaneous — Miscellaneous Products

Rain Jackets and Pants



Warranty: Manufacturer's

- Made with a 0.35 mm (.014 in) PVC exterior laminated to a polyester interior [PVC is a synthetic thermoplastic elastomer (TPE) which provides excellent ozone and weather resistance]
- Double-lapped heat-welded construction
- Non-conductive hardware
- Meets California Proposition 65

Rain Jacket

- Yellow rain jacket with a detachable hood and two patch pockets
- Full snap front
- Inner storm fly prevents rain and debris from penetrating front opening
- Corduroy collar
- Raglan sleeves for maximum mobility (a raglan sleeve is attached to a garment body at a 45 degree angle helping it to stretch from neckline to underarm)
- Take-up snaps at cuff
- Back yoke ventilation

Rain Pants

- Yellow rain pants with fly front overall and pockets with flaps
- Fabric/elastic suspender and elastic waist band
- Take-up snaps at ankle

Part Number	Chest Size	Waist Size	Size
Rain Jacket			
311-2983	Medium, 101.6-106.68 cm (40-42 in)	—	—
311-2984	Large, 111.76-116.84 cm (44-46 in)	—	—
311-2985	XLarge, 121.92-127 cm (48-50 in)	—	—
Rain Pants			
311-2986	—	Medium, 91.44-96.52 cm (36-38 in)	—
311-2987	—	Large, 101.6-106.68 cm (40-42 in)	—
311-2988	—	XLarge, 111.76-116.84 cm (44-46 in)	—
2 Pc Suits			
311-2979	—	—	Medium
311-2980	—	—	Large
311-2981	—	—	XLarge

Miscellaneous — Miscellaneous Products

Paper Cups



Warranty: Cat Standard Warranty, 6 Months

- Two-piece construction with tightly rolled rim
- Fully wax coated inside and out with a satin finish

Part Number	Description	Capacity	Qty.
263-0884	Paper Cups	238.8 ml (8 oz)	2000 per case

Eye Loupe



Warranty: Cat Standard Warranty, 6 Months

- 25.4 mm (1 in) depth
- 12X power
- Extremely portable

Part Number	Description
8S-2257	Loupe

Tie Down Straps



Warranty: Manufacturer's

- Elastic rubber tie down straps with a hook at each end
- Excellent for general tie down applications such as tarps and covers
- Material: SBR Rubber

Part Number	Size
262-9304	8 x 12.6 x 381 mm (.31 x .50 x 15 in)
262-9305	10 x 13 x 533 mm (.39 x .50 x 21 in)

Black Wire

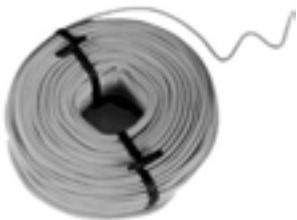

Warranty: Manufacturer's

- Black annealed mechanics tie wire
- Soft and pliable—makes a perfect tie every time

Part Number	Size	Material	Qty.	Length
262-9959	18 gauge	Black iron	1 Roll	177 m (580.71 ft)

Miscellaneous — Miscellaneous Products

Creeper



Warranty: Cat Standard Warranty, 6 Months

- Rugged, one-piece, plastic body construction
- Easy-to-clean surface is resistant to solvents, greases, and fuels
- Body-fitting design, contoured to provide optimum comfort
- Low profile, gives maximum workspace but still clears air hoses
- Six pop-in urethane wheels resist corrosion and provide a smooth ride

Part Number	Description	Dimensions	Wheel Size	Clearance
172-0852	Creepers	965 x 445 x 102 mm (38.0 x 17.5 x 4.0 in)	51 mm (2 in)	22.2 mm (0.87 in)
172-0853	Replacement wheel	—	51 mm (2 in)	—

Funnel Kit



Warranty: Lifetime

Includes:

- - one 1-pint funnel
- - two 1-quart funnels

Part Number	Description
268-5809	Funnel Kit

Funnel



Warranty: Lifetime

Part Number	Description	Length	Material
268-5814	Funnel	457.2 mm (18 in)	Plastic

Miscellaneous — Miscellaneous Products

Sink Filter Sock Kit - 189-5637

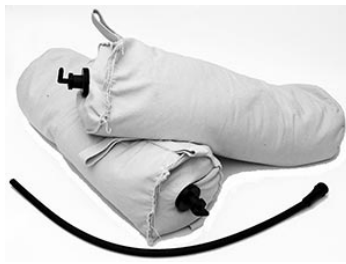

Warranty: Cat Standard Warranty, 6 Months

- Sock filter for solvent stands
- Removes oil from washer solvents
- Two Diatomaceous Earth-filled filter bags, one hose

Part Number	Description
189-5637	Sink Filter Sock Kit

Digital Stopwatch - 386-3238



Warranty: Cat Standard Warranty, 6 Months

- Large digits for easy viewing
- Start/Stop button on both left and right sides
- 10-hour maximum time setting
- Water Resistant
- Five-year battery

Part Number	Description
386-3238	Digital Stopwatch

Python Cinch Straps



Warranty: Caterpillar Standard Warranty, 6 Months

- Nylon with heavy duty nickel plated steel buckle
- Allows hose expansion and contraction without damage
- Easy installation and removal
- UV and Weather Resistant
- Varied lengths from 21 to 29 inches long

Part Number	Width	Length
391-2683	3.81 mm (1.5 in)	533 mm (21 in)
391-2684	3.81 mm (1.5 in)	635 mm (25 in)
391-2685	3.81 mm (1.5 in)	737 mm (29 in)

Miscellaneous — Miscellaneous Products

Plastic Cover – 463-5569



Warranty: Manufacturers Lifetime Warranty

- Custom cover designed to protect the sensors of autonomous hauling machines during washing

Part Number	Description	Length
463-5569	Yellow vinyl cover with drawstring	1000 mm (3.25 ft) x 1600 mm (5.25 ft) x 1000 mm (3.25 ft)

Paint — Cat Paint

Cat Enamel Topcoats

Warranty: Cat Standard Warranty, 6 Months

- Pure, lead free industrial enamel suitable for interior or exterior use on earthmoving, construction and material handling equipment, trucks, engines, machinery, and metal buildings
- Formulated to produce a finish that sets up in minutes, is tack-free in a few hours, and dries overnight to a hard film
- Very resistant to fading, chalking, cracking, and chipping
- Can be applied directly to either wood or metal without using a primer



Part Number	Description	Package Quantity	Size / Type
140-2576	Matterhorn White Paint, High Gloss	12	340 g (12 oz) Aerosol Can
140-2577	Matterhorn White Paint, High Gloss	4	3.8 L (1 Gal) Can
225-6502	Black Paint, High Gloss	4	3.8 L (1 Gal) Can
243-5450	Power Module White Paint, High Gloss	4	3.8 L (1 Gal) Can
243-5451	Power Module White Paint, High Gloss	12	340 g (12 oz) Aerosol Can
249-1815	Power Module White Paint, High Gloss Water Reducible 2.8 VOC	4	3.8 L (1 Gal) Can
4C-4183	Black Paint, Medium Gloss	4	3.8 L (1 Gal) Can
4C-4184	Yellow Paint, High Gloss Fast Drying	4	3.8 L (1 Gal) Can
4C-4185	Hiway Yellow Paint, High Gloss	4	3.8 L (1 Gal) Can
4C-4186	Mojave Brown Paint, Medium Gloss	4	3.8 L (1 Gal) Can
4C-4191	Black Paint, Medium Gloss	1	19 L (5 Gal) Pail
4C-4192	Yellow Paint, High Gloss Fast Drying	1	19 L (5 Gal) Pail
4C-4198	Black Paint, Medium Gloss	12	340 g (12 oz) Aerosol Can
4C-4200	Yellow Paint, High Gloss	12	340 g (12 oz) Aerosol Can
4C-4202	Mojave Brown Paint, Medium Gloss	12	340 g (12 oz) Aerosol Can
4C-4207	Yellow Paint, High Gloss Fast Drying	1	208 L (55 Gal) Drum
4C-5842	Black Paint, Flat	12	340 g (12 oz) Aerosol Can
4C-5843	Black Paint, High Gloss	12	340 g (12 oz) Aerosol Can
4C-6122	Yellow Paint, High Gloss	1	19 L (5 Gal) Pail
4C-6127	Yellow Paint, High Gloss	1	208 L (55 Gal) Drum
4C-6129	Yellow Paint, High Gloss	4	3.8 L (1 Gal) Can
9U-7714	Black Paint, Flat	4	3.8 L (1 Gal) Can

Cat Enamel Topcoats (Cont'd.)

Part Number	Description	Package Quantity	Size / Type
9U-7719	Yellow Paint, High Gloss 3.5 VOC	4	3.8 L (1 Gal) Can
9U-7720	Yellow Paint, High Gloss 3.5 VOC	1	19 L (5 Gal) Pail
9U-7725	Yellow Paint, High Gloss Water Reducible 2.8 VOC	4	3.8 L (1 Gal) Can
9U-7726	Yellow Paint, High Gloss Water Reducible 2.8 VOC	1	19 L (5 Gal) Pail
9U-7731	Black Paint, Medium Gloss Water Reducible 2.8 VOC	4	3.8 L (1 Gal) Can
9U-7946	Bright Beige Paint, Medium Gloss	12	340 g (12 oz) Aerosol Can
9U-7947	Bright Beige Paint, Medium Gloss	4	3.8 L (1 Gal) Can
9U-7949	Dawn Gray, Medium Gloss	4	3.8 L (1 Gal) Can

Cat Black Muffler Paint



Warranty: Cat Standard Warranty, 6 Months

- Formulated for temperatures up to 538°C (1000°F)
- Once properly cured, forms a hard, lasting finish that resists salt spray and will not chip or peel
- Ideal for use on mufflers, exhaust systems, or any surface exposed to very high heat

Part Number	Description	Package Quantity	Size / Type
4C-4199	Black Muffler Paint	12	340 g (12 oz) Aerosol Can

Cat Yellow Primer Paint



Warranty: Cat Standard Warranty, 6 Months

- Pure, lead free rust-inhibitive industrial primer sealer with excellent adhesion and durability
- Specially formulated to resist rusting, peeling, and fading
- Dries tack-free in a few hours and overnight to hard durable coating with excellent weather resistance
- Should be recoated with Cat enamel topcoat paint

Part Number	Description	Package Quantity	Size / Type
4C-4190	Yellow Primer Paint	4	3.8 L (1 Gal) Can
4C-4197	Yellow Primer Paint	1	19 L (5 Gal) Pail
4C-4205	Yellow Primer Paint	12	340 g (12 oz) Aerosol Can

Paints — Paint Thinner

Cat Paint and Primer Thinner



Warranty: Cat Standard Warranty, 6 Months

- Excellent solvent to be used with Cat enamel paint and primer.
- Will not impair the setting-up or tack-free time of the enamel or primer paint.
- Evaporates fast and is less likely to cause sagging and running.
- Because of its high solvency, a relatively small amount of thinner is needed to reduce paint to a spray consistency.

Part Number	Description	Package Quantity	Size / Type
4C-4189	Paint and Primer Thinner	6	3.8 L (1 Gal) Can
4C-4196	Paint and Primer Thinner	1	19 L (5 Gal) Pail

Cat Paint and Primer Thinner with Retarder



Warranty: Cat Standard Warranty, 6 Months

- Excellent solvent to be used with Cat enamel paint and primer.
- Leaves film slowly to provide flow and leveling in hot or dry conditions and on large equipment where slower drying is desired.
- Evaporates slowly and is less likely to cause dry over-spray.
- Because of its high solvency, a relatively small amount of thinner is needed to reduce paint to a spray consistency.

Part Number	Description	Package Quantity	Size / Type
4C-6130	Paint and Primer Thinner with Retarder	6	3.8 L (1 Gal) Can

Maintenance Chemicals — Soaps and Cleaners

Windshield Cleaner



Warranty: Manufacturer's

- Good for all types of glass
- Safe for plastics, vinyl, tile, and all hard surfaces
- Non-streaking
- Dries completely
- Does not leave a film

Part Number	Size
222-3120	340 g (11.99 oz)

Xtreme Windshield Washer Fluid



Warranty: Manufacturer's

- Blue-tinted windshield cleaner and de-icer
- Effective to -28.89° C (-20° F)

Part Number	Size	Package Quantity
271-1648	3.79 L (1 gal) jug	6

Plastic and Rubber Protectant



Warranty: Manufacturer's

- Contains no silicone
- Formulated with UV inhibitors to protect surface area
- Cleans and protects

Part Number	Size
222-3122	340 g (11.99 oz)

Seal Installation Kit



Warranty: Cat Standard Warranty, 6 Months

- N/A in EAME
- Used to clean and lubricate Duo Cone seals prior to installation (developed by Cat MVC)
- Cleaner dries quickly and leaves no film
- For best results, use cleaner, lubricant, and critical task wipers

Maintenance Chemicals — Soaps and Cleaners

Seal Installation Kit (Cont'd.)

Part Number	Description	Size	Seal Cleaner	Seal Lubricant	Critical Task Wipers
169-0503	—	—	237 ml (8 oz.)	237 ml (8 oz.)	203 x 203 mm (8 x 8 in); 50 per package
Seal Installation Kit consist					
169-5418	Seal Lubricant (1 Gallon)	3.8 L (1 gal)	—	—	—
169-5420	Seal Cleaner (1 Gallon)	3.8 L (1 gal)	—	—	—
265-2256	Low Lint Task Wipers	—	—	—	—

Air Filter Cleaning Kit



Warranty: Manufacturer's

- Used to clean air filter elements
- For use in AIRSEPS technology in marine engine applications
- Specially formulated for removing dirt from cotton gauze air filters — prevents shrinkage or other damage to filter element when used according to manufacturer's directions
- Air filter oil greatly increases effectiveness of filter — oil is added to filter after cleaning
- System includes Formulated Cleaning Solution, Genuine Red Oil, and spray nozzle
- Cleans four 228.6 x 228.6 mm (9 x 9 in) tapered filters or equivalent

Part Number	Description	Qty.
102-9720	Air Filter Cleaning Kit	—

Cabinet Washers and Agitating Tanks



Warranty: Manufacturer's

Cat Cabinet and Tank Liquid and Cat Cabinet and Tank Powder

- Strong alkaline cleaners that remove dirt, oils, paint, and carbon deposits from ferrous metal parts
- Clean better than previous Hydrosolv products due to increased levels of surfactants and wetting agents
- Well suited for use in cabinet pressure washers and hot tanks

Cat Aluminum, Safe Cabinet and Tank Powder

- Non-foaming aluminum safe cleaner
- Strong alkaline cleaner that removes dirt, oils, paint, and carbon deposits from aluminum and ferrous metal parts without discoloration
- Well suited for use in cabinet pressure washers and hot tanks

Maintenance Chemicals — Soaps and Cleaners

Cabinet Washers and Agitating Tanks (Cont'd.)

Part Number	EAME Part Number	Name	Qty.	Size
174-6854	N/A	Cat Cabinet & Tank Liquid	1	18.9 L (5 gal)
174-6855	185-4593	Cat Cabinet & Tank Liquid	1	208.2 L (55 gal)
174-6856	N/A	Cat Cabinet & Tank Powder	1	16 kg (35 lb)
174-6857	N/A	Cat Cabinet & Tank Powder	1	181 kg (400 lb)
4C-8648	N/A	Cat Aluminum, Safe Cabinet and Tank Powder	1	4 kg (8 lb)
4C-8650	N/A	Cat Aluminum, Safe Cabinet and Tank Powder	1	205 kg (450 lb)

Pressure Wash



Warranty: Manufacturer's

Hydrosolv 4165

- Heavy-duty concentrated alkaline cleaner formulated for use in high-pressure washers
- Provides two weeks rust protection if you do not rinse the part after cleaning

Part Number	EAME Part Number	Name	Qty.	Size
1U-5490	185-4619	Cat HD Pressure Wash	1	18.9 L (5 gal)

Defoamant and Descaleant/Conditioner



Warranty: Manufacturer's

Hydrosolv defoamant DK100

- Designed to knock down excess foam in hot tanks, cabinet washers, anti-freeze stills, or any other aqueous foaming solution

Hydrosolv Descaleant and Conditioner

- Can be used as a concentrate to remove scale from pumps, lines and coils
- Should be diluted 50% and used as a water conditioner for high-pressure washers having automatic water conditioner dispensers

Part Number	EAME Part Number	Description	Qty.	Size
1U-9698	—	Hydrosolv Descaleant and Conditioner	12	1 quart

Maintenance Chemicals — Soaps and Cleaners

General Purpose Detergents



Warranty: Cat Standard Warranty, 6 Months

Cat GP Wash

- Economical ready-to-use general-purpose liquid cleaner for shop maintenance, machine washing, floor washing, etc.
- Provides good detergency for all types of light duty cleaning

Part Number	EAME Part Number	Name	Qty.	Size
174-6860	N/A	Cat GP Wash	1	18.9 L (5 gal)
174-6861	N/A	Cat GP Wash	1	208.2 L (55 gal)

Chemtool LAC 110 All-Purpose Cleaner Concentrate

Warranty: Manufacturer's

- Concentrated all-purpose cleaner and degreaser
- USDA-approved for effectiveness and safety
- Bio-degradable, non-phosphorous for all washing applications including homes, RV's, office industry equipment, automobiles, and boats

Part Number	Size
269-8297	18.93 L (5 gal) bucket

Cat Orange Hand Cleaner



Warranty: Cat Standard Warranty, 6 Months

- Excellent hand cleaner for dirty, oily, greasy hands. For exceptionally dirty or greasy hands, use Hand Cleaner with Pumice.
- Mild citrus smell
- Contains Corn Huskers Lotion, aloe, lanolin and jojoba to help prevent dermatitis
- Contains no petroleum solvents
- Biodegradable
- Works with or without water

Part Number	Description	Size ⁽¹⁾	Qty.
9U-5027	Orange Hand Cleaner (smooth)	3.8 L (1 gal)	4
9U-5029	Orange Hand Cleaner (w/ pumice)	3.8 L (1 gal)	4
9U-5030	Wall Mount Bracket for 1 gal container	—	1

¹ All 1 gallon jugs come with individual pumps included. 7.5 fl.oz. bottles have self-sealing flip top caps.

Maintenance Chemicals — Soaps and Cleaners

Cat Heavy-Duty Hand Cleaners



Warranty: Cat Standard Warranty, 6 Months

- Heavy-duty hand cleaner for oil, grease, tar, grime, soil, resins, printer's ink, epoxies, paint, and cements
- Works faster than standard orange hand cleaner
- Fine ground pumice provides a deep scrubbing action to remove difficult grease and grime
- Pleasant scent with lanolin and aloe
- Will not irritate most hands and does not leave a greasy residue

Part Number	Description	Size
191-6310	Heavy-Duty Hand Cleaner	15 oz

Cat Battery Cleaner



Warranty: Cat Standard Warranty, 6 Months

- Dissolves and neutralizes battery acid and harmful corrosion from battery parts, terminals, cables, hold-downs, and boxes
- Recommended for construction and industrial equipment batteries
- Can be used on automobile, marine, and industrial batteries

Part Number	Size
222-3111	340 g (11.99 oz)

Cat Battery Saver



Warranty: Cat Standard Warranty, 6 Months

- Creates a protective coating, giving maximum battery protection
- Recommended for use on all battery installations
- Keeps dirt and other contaminants from interfering with the flow of power
- Prolongs battery, cable, and clamp life

Part Number	Size
222-3112	340 g (11.99 oz)

Maintenance Chemicals — Soaps and Cleaners

Cat Mineral Spirits



Warranty: Cat Standard Warranty, 6 Months

- For use in solvent stands, immersion tanks, and manual cleaning equipment
- Can be used with brush, rags, or spray
- Has minimum flash point of 96°C (205°F) COC
- High quality product with excellent solvency and is capable of being recycled indefinitely through a solvent reclaiming still
- If used in spray equipment, follow recommendations of spray equipment manufacturer

Part Number	Size
4C-6796	18.79 L (5 Gal)
4C-6797	208 L (55 Gal)

Maintenance Chemicals — Adhesives and Sealants

Clear Adhesive Sealant



Warranty: Manufacturer's

- Holds seals in place during assembly
- Used for Single Cylinder Oil Test Engines (SCOTE)

Part Number	Size
1Y-3904	20 ml (0.68 fl oz) syringe

Heat Sink Compound

Warranty: Manufacturer's

- High thermal conductivity
- Does not break down
- No migration
- Protects high current carrying semi-conductors, power transistors, diodes, and SCR's

Part Number	EAME Part Number	Size
5P-8937	186-1529	142 g (5.01 oz)

High Temperature Anti-Seize



Warranty: Manufacturer's

- Allows easy loosening of joined parts in high temperature environments
- Matches Caterpillar production specifications
- Heavy-duty

Part Number	Description	Size	Qty.
5P-3931	Anti-seize Lubricant	1.13 kg (40 oz)	12

Cat Manifold Sealer



Warranty: Cat Standard Warranty, 6 Months

- Seals and bonds at temperatures up to 1093°C (2000°F)
- Seals male/female joints in segmented exhaust manifolds

Part Number	Size	Qty.
2P-2333	473 ml (15.99 fl oz)	1

Maintenance Chemicals — Adhesives and Sealants

Window Bonding Adhesives and Tooling

Warranty: Manufacturer's

Part Number	Description	Size
9U-6919	Butyl Sealant	3/8 inch x 1/8 inch x 50 foot roll
Primer for polycarbonate:		
121-3911	Window Primer	250 ml (8.5 oz) tube
Primer for ABS plastic:		
166-1359	ABS Primer	250 ml (8.5 oz) tube

To Bond Large Windows

Warranty: Manufacturer's

Clean the area to be repaired with brake cleaner. Use window primer to prepare the area. Wait 10 minutes, then apply window adhesive to the area.

See SEHS9824-01 Special Instruction (6/99) for detailed instructions.

Part Number	EAME Part Number	Description	Size
To reseal windows with weather-strip:			
121-3908	187-4856	Window Adhesive	310 ml (10.5 oz) tube
121-3911	121-3911	Window Primer	250 ml (8.5 oz) tube

Epoxy Adhesive, Nozzle Mixer, Applicator (Model 3500)



Model: 3500

Warranty: Manufacturer's

- Fast cure adhesive
- 30 minute handling strength

Part Number	Description	Shear Strength	Pot Life	Mix Ratio	Size
143-9508	Epoxy Adhesive	2500 PSI	9 minutes	1:1	48.2 g (1.70 oz)
143-9509	Nozzle Mixer	—	—	—	—
143-9510	Applicator	—	—	—	—
143-9511	Plunger	—	—	—	—

Maintenance Chemicals — Lubricants

CT2 Air Tool Oil/Lubricant



Warranty: Manufacturer's

- Lubricates and protects piston-type or rotary pneumatic air tools
- Prevents rust/corrosion

Part Number	Size	Package Quantity
269-1944	0.95 L (1 qt) bottle	12

Cat Heavy Duty Penetrating Oil



Warranty: Cat Standard Warranty, 6 Months

- Quickly loosens stubborn parts—frozen nuts, bolts, pipe fittings, heat valves, rolling pins, press fit parts, and key ways
- Heavy-duty
- Enhanced penetration action

Part Number	Size
222-3115	340 g (11.99 oz)

Cat Dry Film Lubricant



Warranty: Cat Standard Warranty, 6 Months

- Dry, low-friction lubricant
- Does not attract dust or dirt
- For use with sliding surfaces, such as motor grader blades circles and backhoe loader extended stick and side shift mechanisms

Part Number	Size
242-6990	340 g (11.99 oz)

Cat Chain and Cable Lubricant



Warranty: Cat Standard Warranty, 6 Months

- Good corrosion and rust resistance
- Reduces and protects chain against wear—increases life of chain and cable
- Foaming action that helps cover all surfaces
- Fast penetrating action
- Resists high temperature breakdown

Maintenance Chemicals — Lubricants

Cat Chain and Cable Lubricant (Cont'd.)

Part Number	Size	Qty.
222-3110	340 g (12 fl oz)	12

Cat Camshaft and Follower Lubricant



Warranty: Cat Standard Warranty, 6 Months

- Prevents galling on camshafts with slipper type followers
- Apply during engine buildup to provide necessary lubrication at startup

Part Number	EAME Part Number	Size	Qty.
8T-2998	185-4758	236 ml (7.98 fl oz)	12

Cat Silicone Lubricant



Warranty: Cat Standard Warranty, 6 Months

- Silicone grease
- Extreme temperature resistance
- Lubricant for rubber boots on Cat flexible drive couplings on marine engines
- Not for use on silicone O-rings (yellow or white) or hoses

Part Number	EAME Part Number	Size	Qty.
5N-5561	186-1528	340 g (11.99 oz)	10

Cat Air Conditioning Pump Lubricants—PAG Oil



Warranty: Cat Standard Warranty, 6 Months

- Specially formulated lubricants for use with R-134a Refrigerants

Part Number	Size	Qty.	Oil Type	Viscosity
4C-2959	250 ml (8.45 fl oz)	1	Polyalkylene glycol oil for Sanden compressors	Low Viscosity refrigerant oil for R-134a
4C-2960	250 ml (8.45 fl oz)	1	Polyester oil	ISO Viscosity refrigerant oil for R-134a
9U-7551	250 ml (8.45 fl oz)	1	Polyalkylene glycol oil	High Viscosity refrigerant oil for R-134a

Rubber Lubricant



Warranty: Manufacturer's

- Lubricates rubber to metal during tire mounting and dismounting
- Helps prevent rim corrosion and damage to bead surfaces
- Renews appearance of rubber and vinyl products
- Prevents squeaks in rubber parts

Part Number	Size
5P-3975	3.79 L (1 gal)

Cat P-80 Assembly Lubricant



Warranty: Cat Standard Warranty, 6 Months

- Specially formulated liquid that lubricates rubber so it is easy to install, remove, or otherwise manipulate
- Unique feature—its ability to provide temporary lubrication (Once the work with the rubber is complete, emulsion rubber lubricant disappears and surfaces return to original condition.)
- Provides high degree of lubricity while wet; stays wet long enough to complete the work, then it's gone; contains no silicones or other persistent ingredients so lubricity goes away completely
- Lubricated parts won't crumble, tear, or lose their elasticity; lubricant does not harm glass, metal, wood, or other materials
- Keep emulsion rubber lubricant out of freezing or near-freezing temperatures. In colder climates be especially careful not to leave emulsion rubber lubricant in any unheated area for lengthy periods.

Part Number	Size
207-1601	1 L (0.25 gal)

Cat Tire Lubricant



Warranty: Cat Standard Warranty, 6 Months

- Contains no soaps
- Leaves no residue — will not rust rims
- Helps seal tire to rim without bonding
- Reduces bead damage
- Nontoxic, odorless

Part Number	Description	Size
139-2398	Lubricant	3.8 L (1 gal)

Maintenance Chemicals — Metal Working

Cat 119 Cutting Oil



Warranty: Caterpillar Standard Warranty, 6 Months

- Straight cutting oil for machining ferrous metal
- Drilling, tapping, honing
- Contains chlorine and sulfur for optimum tool life and finish
- Compounded for easy removal with no troublesome residues

Part Number	Qty.	Size
1U-8805	4	3.8 L (1 gal)

Cat 250 Grinding Fluid



Warranty: Caterpillar Standard Warranty, 6 Months

- Water soluble cutting oil, grinding fluid and coolant
- Drilling, tapping, honing non-ferrous metals
- Grinding on crankshafts, etc.
- Compounded for easy removal with no troublesome residues
- Formulated with built-in biocide to control bacteria that cause odors and dermatitis

Part Number	Qty.	Size
1U-8808	4	3.8 L (1 gal)

DYKEM Hi Spot Bluing Paste



Warranty: Manufacturer's

- Intensely blue, soft, uniform paste that spreads easily and evenly to show high spots on bearings
- Used on flat bearing surfaces of lathes, planers, and milling machines

Part Number	Size	Package Quantity
280-1555	15.59 g (0.55 oz) tube	36

Maintenance Chemicals — Testing Products

Oil Dyes



Warranty: Manufacturer's

- Highly concentrated oil soluble dyes for adding color to lubricating oils, transmission oils, hydraulic oils and fuels
- Visible at concentrations of 1 part in 10,000 or more. It only takes 30 ml (1 oz) to color 473 l (125 gal) of light color oil
- Use it to color code oils to prevent mixups
- Use it to identify the source of leaks when more than one source is possible
- Hint: For sumps with dark colored oil, use oil dyes which are visible in black light (ultraviolet) such as 1U-5572 through 1U-5575

Part Number	Color	Size
9U-5031	Red	240 ml (8.12 fl oz)
9U-5032	Blue	240 ml (8.12 fl oz)

Aerosol Liquid Penetrant and Developer



Warranty: Manufacturer's

- Checks for surface cracks in ferrous and non-ferrous parts with regular light
- Contains no chlorine or sulphur bearing solvent
- Conforms to MIL-1-25135, RDT F-3-6T standard and other military specifications
- Simple and easy to use

Cross Reference Chart for Liquid Penetrant Kit						
Description	Cat/Crown Fault Finder	Magnaflux Spot Check	Turco By Check	Sherwin Dubl-Check	Met-L- Check	Min. Ship. Qty.
Penetrant, Aerosol	4C-4804	SKL-S	By Check	DP-40	VP-31	12 each
Developer, Aerosol	4C-4805	SKD-NF	By Check	D-100	D-70	12 each

Maintenance Chemicals — Testing Products

UV Visible Dyes for Leak Detection



Warranty: Manufacturer's

- Detects leaks in light or dark oils, fuels, water solutions

Part Number	Description	Size	Dosage
To detect oil leaks in engines, transmission, hydraulic systems, etc.			
1U-5572	Oil Glo 22 Additive	28.4 g (1 oz) bottle	28.4 g (1 oz) per 7.58 L (2 gal) of oil
1U-5573	Oil Glo 22 Additive	0.47 L (1 pt) bottle	28.4 g (1 oz) per 7.58 L (2 gal) of oil
To detect fuel leaks or suspected fuel dilution			
1U-5574	Gas Glo 32 Additive	28.4 g (1 oz) bottle	28.4 g (1 oz) per 37.9 L (10 gal) of gasoline or diesel fuel
1U-5575	Gas Glo 32 Additive	0.47 L (1 pt) bottle	28.4 g (1 oz) per 37.9 L (10 gal) of gasoline or diesel fuel
To detect cooling system leaks, use:			
1U-5576	Water Glo 23 Additive	28.4 g (1 oz) bottle	28.4 g (1 oz) per 151.6 L (40 gal) of water
1U-5577	Water Glo 23 Additive	0.47 L (1 pt) bottle	28.4 g (1 oz) per 151.6 L (40 gal) of water

Maintenance Chemicals — Testing Products

UV Flashlight Kit - 459-0184



Warranty: Manufacturer, one year

- OPTI-LUX 365 UV-A LED Inspection Flashlight
- 10,000 $\mu\text{W}/\text{cm}^2$ of UV-A (365 nm) light at 38 cm (15 in)
- Instant on at full intensity
- Each charge provides four hours of continuous operation
- 100,000-hour LED service life
- Rugged anodized aluminum body
- Kit also contains:
 - One pair UVS-30 absorbing Cat safety glasses with ANSI, AUS/NZ, CE, CSA certifications
 - Spare battery
 - Global charger set
 - ◆ 100-120v
 - ◆ 230v EU/CE
 - ◆ 240v AUS/CE
 - ◆ 230v UK/CE
 - Lanyard
 - Holster
 - Storage case
- Weight 130 g (4.6 oz)
- Meets ASTM UV-A intensity and wavelength specifications for FPI and MPI
- CE marked

Leak Detection Kit



Warranty: Manufacturer's

- Handheld
- An anodized aluminum lamp housing
- Makes it easier and quicker to detect leaks in oil, fuel and cooling systems
- Additives, available separately, can be put in the suspect system and the leak point will show in the black light (ultraviolet light)
- Instructions come with the kit
- Also works with fluorescent penetrant kit
- Optional light cover, made of heat-resistant neoprene rubber, helps protect the user from possible burn injury, and also provides protection against mechanical shock damage

Part Number	Description
1U-5566	Black Light 120 Volt Kit
280-8961	Black Light 240 Volt Kit

Maintenance Chemicals — Testing Products

Leak Detection Kit (Cont'd.)

Part Number	Description
Service Parts	
1U-5567	Black Light Filter
1U-5568	110V, 150 Watt Spot Bulb
Optional Items	
280-8144	120V/100 Watt Ultraviolet Spot Bulb, 30 mm Base, Average Intensity 7000 milliwatts
280-8147	120V/100 Watt Ultraviolet Spot Bulb, 26 mm Base, Average Intensity 7000 milliwatts
280-8148	240V/150 Watt Ultraviolet Spot Bulb, Average Intensity 7000 milliwatts

Cat Calibration Fluid



Warranty: Cat Standard Warranty, 6 Months

- Fuel injection test benches
- Pop Testers

Part Number	Size
6V-6067	208 L (55 US gal)
6V-6068	18.9 L (5 US gal)

Gear Marking Compound - 381-0022



Cat Standard Warranty, 6 Months

- Used to mark gears during rebuild or service
- Mineral oil and iron oxide powder mixture
- NLGI #4 consistency

Part Number	Volume
381-0022	118 mL (4 oz.)

Maintenance Chemicals — Rust Preventatives

Cat Rust Preventive Oil 450



Warranty: Caterpillar Standard Warranty, 6 Months

- Water displacing rust preventive oil is more strongly attracted to bare metal than water
- Apply by dipping, brushing, or spraying
- Leaves a long lasting, rust preventive film that protects against rusting for a year in covered storage conditions
- Should be protected from dirt and dust accumulation to prolong its effectiveness

Part Number	Qty.	Size
1U-8809	4	473 ml (16 oz)

Cat Rust Preventive Oil 4A



Warranty: Caterpillar Standard Warranty, 6 Months

- Long lasting, heavy-duty waxy film
- Apply by dipping, brushing, or spraying
- Leaves a long lasting, rust preventive film that protects from damage by outside condensation, rainfall, etc. up to a year
- Must be removed with solvent or hot alkaline cleaner

Part Number	Qty.	Size
1U-8801	4	3.8 L (1 gal)

V.C.I. Oil



Warranty: Manufacturer's

Reference

SEHS9031 Special Instructions

- Use for storing vehicles and vehicle components such as engines and transmissions for periods of up to one year
- Protects all ferrous parts when maintained at the proper concentration in a closed container
- Has a vapor phase that is more strongly attracted to bare ferrous metals than water
- Will continue to perform indefinitely as long as it stays sealed in the compartment
- Meets Mil-P-46002A

Part Number	Qty.	Size
4C-6792	12	1 L (0.25 gal)
4C-6794	1	18.93 L (5 gal)

Maintenance Chemicals — Miscellaneous Chemicals

Ether Cylinder



Warranty: Manufacturer's

- Cold weather starting aid
- Heavy-duty construction
- Quick starts from -45.5°C (-50°F)
- Easy to install, hand tighten
- 7.6 cm (3 in) diameter
- For measured shot systems

Part Number	Qty.	Size
7X-1062	12	21 oz (595 g)
7N-0296	12	18 oz (510 g)
130-8414	12	8 oz (226 g)

CT2 Antifreeze and Rust Guard



Warranty: Manufacturer's

- Provides corrosion protection and prevention for air breaking system
- Anti-static and anti-fungal
- Also used in pneumatic hose lines

Part Number	Size	Package Quantity
272-5745	0.95 L (1 qt) bottle	12

Anti-Spatter Compound



Warranty: Manufacturer's

- Protects tips on MIG welding torches from weld spatter

Part Number	Qty.	Size
4C-4217	12	207 ml (7 fl oz)

Maintenance Chemicals — Miscellaneous Chemicals

Thermally Conductive RTV Kit

Warranty: Manufacturer's

- Increases thermal conductivity between diode and aluminum heat sink assembly on rotating field of power generator
- High thermal conductivity and electrical isolation
- Conformable, cure in place thermal interface
- Storage at or near freezing (0° C (32° F) prolongs product life
- Also see heat sink compound

Part Number	Description	Shelf Life
4C-6715	RTV Kit	6 months at 24° C (75° F)

Cat Vacuum Pump Oil



Warranty: Caterpillar Standard Warranty, 6 Months

- Approved for all Cat vacuum pumps
- All vacuum pump suppliers recommend changing the vacuum pump oil after every pump down to prevent contamination of the next system to be serviced

Part Number	Qty.	Size
1U-9763	12	0.95 L (1 qt)

UPS 250 Vacuum Pump Oil

Warranty: Manufacturer's

- An annual service schedule for UPS 250 vacuum pump is recommended

Part Number	Capacity of Pump ⁽¹⁾	Size
190-8487	0.7 L (23.67 oz)	1 L (33.81 oz)

¹ Caterpillar UPS Vacuum Pumps have a capacity of .7 L and should not be filled beyond sight gauge fill line. Failure to follow this instruction will cause oil to leak from pump. (PEHJ0152)

Maintenance Chemicals — Miscellaneous Chemicals

Dielectric Tune-Up Grease



Warranty: Manufacturer's

- Silicone grease — lubricate open electrical connections
- Prevents fusing of spark plug boots

Part Number	Size
151-1340	9 ml (0.30 fl oz)

Cat Rust Preventative



Warranty: Cat Standard Warranty, 6 Months

- Provides a hard film surface with good corrosion and rust resistance
- Protects equipment stored outside
- Helps protect equipment used around salty environments
- Provides protection in humid environments

Part Number	Size
222-3121	473 ml (16 oz)

Cat Silicone Fluid



Warranty: Cat Standard Warranty, 6 Months

- For fan drive assemblies and clutches with viscous fluid drives

Part Number	Size	Used in
4C-6508	300 ml (10.14 fl oz)	3600 Visconic Damper

Part Number Index

Part.No.	Page.No.	Part.No.	Page.No.	Part.No.	Page.No.	Part.No.	Page.No.
030-4606	283	143-9511	422	161-3983	58, 61	178-1628	279
034-1432	405	144-4674	26	161-3985	61	178-2212	191
068-0710	284	146-2728	18, 182	162-5791	372	178-2213	191
090-9019	283	147-6456	320	162-7804	147	178-7635	278
093-1321	285	148-5675	192	162-8716	13, 23, 57, 62	179-3571	278
093-1322	285	148-5677	192	162-8718	137	179-7043	313
093-1323	285	150-1197	213	163-0798	356	179-7046	313
096-3829	285	150-1244	212-213	163-0799	356	179-7047	314
096-6073	285	150-1246	213	165-3945	217	179-7048	313-314
0V-0455	49	150-1248	213	165-3946	217	179-7049	313-315
102-9720	416	150-1250	213	165-3947	217	179-7050	313-314
121-3908	422	150-1251	213	165-3977	161	179-7053	314
121-3911	422	150-1252	213	166-1359	422	179-7054	315
124-0662	93	150-1578	354	168-0383	12, 16, 57, 62	179-7056	315
127-1909	297	150-1579	355	168-7955	95	179-7058	315
127-2277	37	150-5431	215, 218	168-8395	107	185-3630	19-24, 26, 29, 43, 182
127-2278	37	151-0968	116	169-0503	416	185-4593	417
127-2279	37	151-1340	434	169-0782	107	185-4619	417
127-2280	37	151-8101	215	169-5418	416	185-4758	424
128-8824	50	151-8102	215	169-5420	416	186-1528	424
128-8825	50	152-1058	103	169-7372	365-366	186-1529	421
129-1063	181	152-4942	27	169-7373	365-366	187-2718	43
129-4552	107	152-7997	193	169-8373	366	187-4856	422
129-4553	107	154-9315	255	170-8604	379	188-2143	294
130-8414	432	154-9316	255	170-8605	379	188-2145	294
132-8743	96, 104	154-9317	255	172-0852	409	188-2147	294
133-8877	26	154-9318	255	172-0853	409	188-2163	294
135-7628	206	154-9319	255	174-6854	417	188-2167	294
136-1452	153	155-3046	108	174-6855	417	188-2170	294
136-5189	104	156-0927	132	174-6856	417	189-5637	410
136-5190	96, 104	156-0930	131	174-6857	417	190-1668	144
138-3856	384	156-0931	131	174-6860	418	190-1669	144
138-4523	215	156-0932	131	174-6861	418	190-1670	144
138-4524	215	156-2568	139	174-8900	227	190-5622	144
138-4528	215	156-8166	256, 277	174-8901	227	190-5623	144
138-4529	215	157-0674	23	174-8902	227	190-8487	433
138-4530	215	157-2264	181	174-8903	227	190-9792	388
138-4534	215	157-2266	181	174-8904	228	191-6310	419
138-4535	215	157-2268	181	174-8905	228	193-0071	352
138-4536	215	157-2269	181	174-8906	228	193-0766	352
139-2398	425	157-2273	181	174-8907	228	194-3480	65, 98
139-2788	319	157-2276	181	174-8908	228	194-3483	65, 98
139-2789	319	157-2278	181	174-8909	228	194-3488	65, 98
140-2576	412	158-8723	113	174-8910	228	194-3490	65, 98
140-2577	412	159-2833	105, 110	174-8911	228	194-3492	65, 98
140-8780	107	159-5155	383	174-9803	190	194-3494	65
140-9921	279	159-5160	383	175-6797	103	194-3495	65
141-1655	309	160-0772	178	175-7546	169	194-3496	65
141-7250	278	160-0774	178	176-1691	279	194-3497	65
143-2459	159	160-0775	179	177-0364	169	194-3498	65
143-2460	159	160-1749	255	177-0365	169	194-3499	65
143-9508	422	160-5119	163	177-0366	169	194-3500	65
143-9509	422	160-6389	13, 58, 61	177-0367	169	194-3505	72, 101
143-9510	422	160-6390	61, 137	177-9343	366		

Part Number Index

Part No.	Page No.	Part No.	Page No.	Part No.	Page No.	Part No.	Page No.
194-3506	72, 101	195-4609	177	1P-2382	139	1P-3039	250
194-3510	72, 101	196-1168	159	1P-2851	51	1P-3040	250
194-3511	72, 101	196-1331	159	1P-2852	51	1P-3041	250, 277
194-3512	72, 101	198-9142	175	1P-2853	51	1P-3042	250, 277
194-3513	72, 101	198-9143	175	1P-2854	51	1P-3043	250, 276
194-3514	72, 101	198-9144	175	1P-2856	51	1P-3044	250, 276
194-3515	72, 101	198-9145	175	1P-2874	181	1P-3045	276
194-3516	72, 101	199-3947	250	1P-2979	253	1P-3047	251-252, 257
194-3517	72, 101	199-6149	71, 100	1P-2980	253	1P-3048	251-252, 257
194-3518	69, 97	199-6150	23, 71, 100	1P-2981	253	1P-3050	252
194-3519	69, 97	199-6152	71, 101	1P-2982	253	1P-3070	251
194-3521	69, 97	199-6153	71, 101	1P-2983	253	1P-3093	277
194-3522	69, 97	199-6154	21, 23, 25, 71,	1P-2984	253	1P-3095	277
194-3523	69, 97		101	1P-2985	253	1P-3501	37
194-3527	69, 97	199-6156	19, 71	1P-2986	253	1P-3502	37
194-3528	69, 97	199-9019	19, 66	1P-2987	253	1P-3503	37
194-3529	69, 97	199-9023	66	1P-2988	253	1P-3504	37
194-3530	69, 97	199-9025	66	1P-2989	253	1P-3505	37
194-3531	109	199-9026	26, 66	1P-2990	253	1P-3506	37-38
194-3532	109	199-9027	66	1P-2991	253	1P-3507	37-38
194-3533	109	199-9028	66	1P-2992	253	1P-3508	37-38
194-3534	109	199-9029	26, 66	1P-2993	253	1P-3509	37-38
194-3535	21, 26, 109	199-9030	66	1P-2994	253	1P-3510	37-38
194-3536	109	199-9031	66	1P-2995	253	1P-3511	37-38
194-3537	109	199-9032	26, 66	1P-2996	253	1P-3512	37-38
194-3538	21, 26, 109	199-9033	66	1P-2997	253	1P-3513	37-38
194-3539	109	199-9034	66, 98	1P-2998	253-254	1P-3514	37-38
194-3540	109	199-9035	26, 66, 98	1P-3000	253	1P-3515	37
194-3541	107	1A-2209	63	1P-3007	249	1P-3566	47, 106
194-3542	107	1B-4657	111	1P-3008	249	1P-5559	48
194-3543	107	1B-5170	284	1P-3010	249	1P-5571	206
194-3544	107	1B-5174	284	1P-3012	249	1P-5572	206
194-3545	107	1B-7810	158	1P-3014	249	1P-5573	206
194-3546	107	1B-9925	259	1P-3015	249	1P-5574	206
194-3547	107	1F-1159	14, 17	1P-3016	249	1P-7421	250
194-3548	107	1F-1161	14, 17	1P-3017	249	1P-7422	252
194-3549	107	1H-8134	63	1P-3018	249	1P-7460	141
194-3552	168	1J-9671	283	1P-3019	249	1S-0253	13, 29-30
194-3553	162	1N-5998	283	1P-3021	250	1S-0254	13, 17, 28, 30
194-3556	162	1N-5999	283	1P-3022	250	1S-0257	14, 17, 158
194-3558	101	1P-0545	20, 23	1P-3023	250	1S-0258	14, 17, 158
194-3559	101	1P-0551	43	1P-3024	250	1S-0259	12, 16, 19-20,
194-3560	145	1P-0810	389		250, 277		56, 89
194-3562	101	1P-0853	114	1P-3025	250	1S-2475	182
194-3563	101	1P-1853	152	1P-3026	250, 277	1S-9593	405
194-3564	101	1P-1854	152	1P-3027	250, 277	1U-5227	405
194-3565	21, 24, 101	1P-1855	152	1P-3028	250	1U-5228	405
194-3566	101	1P-1855	152	1P-3029	250, 277	1U-5386	245-246
194-3567	101	1P-1856	152	1P-3030	250	1U-5387	245-246
194-3574	18, 65	1P-1857	152	1P-3031	250, 277	1U-5388	245-246
194-3576	18, 72	1P-1858	152	1P-3032	251	1U-5389	245-246
194-3578	18, 69	1P-1859	152	1P-3033	250, 277	1U-5390	245-246
194-3584	18, 109	1P-1860	152	1P-3034	250	1U-5391	245-246
194-3585	19, 107	1P-1861	152	1P-3035	250	1U-5392	245-246
194-4935	38	1P-1862	152	1P-3036	250, 277	1U-5393	245-246
194-4944	61	1P-1863	152	1P-3037	250	1U-5394	245-246
		1P-1864	152	1P-3038	250, 277		

Part Number Index

Part.No.	Page.No.	Part.No.	Page.No.	Part.No.	Page.No.	Part.No.	Page.No.
1U-5395	245-246	1U-5599	243	1U-5687	244	1U-6786	230
1U-5396	245-246	1U-5600	243	1U-5688	244, 270	1U-6787	230
1U-5397	245-246	1U-5601	243	1U-5689	244	1U-6788	227
1U-5398	245-246	1U-5602	243	1U-5690	244, 269, 275	1U-6789	227
1U-5399	246	1U-5603	243, 274	1U-5691	244, 270	1U-6790	227
1U-5400	246	1U-5604	243	1U-5692	244	1U-6791	227
1U-5401	246	1U-5605	243	1U-5693	244	1U-6792	227
1U-5402	246	1U-5606	243, 277	1U-5694	244, 269	1U-6793	227
1U-5403	246	1U-5607	243, 274	1U-5695	244	1U-6794	227
1U-5404	246	1U-5608	243	1U-5696	244, 275	1U-6796	227
1U-5405	246	1U-5609	243	1U-5697	244	1U-6809	228
1U-5406	246	1U-5610	243, 277	1U-5698	244, 268	1U-6810	228
1U-5407	246	1U-5611	243, 274	1U-5699	244, 277	1U-6811	228
1U-5408	246	1U-5612	243	1U-5700	244, 275	1U-6812	238
1U-5409	246	1U-5613	243	1U-5701	244	1U-6813	238
1U-5410	246	1U-5614	243, 277	1U-5702	244, 268-269	1U-6814	238
1U-5411	246	1U-5615	243, 275	1U-5703	244, 277	1U-6815	238
1U-5412	246	1U-5616	243	1U-5705	244	1U-6816	238
1U-5413	246	1U-5617	243	1U-5707	244, 276	1U-6817	231
1U-5414	246	1U-5620	245	1U-5709	244	1U-6818	231
1U-5432	370-371	1U-5621	244-245	1U-5711	244, 276	1U-6819	231
1U-5490	417	1U-5622	244-245	1U-5713	244	1U-6820	237
1U-5512	232	1U-5623	244-245	1U-5714	243	1U-6821	237
1U-5513	232	1U-5624	244-245	1U-5715	93	1U-6822	237
1U-5514	232	1U-5625	244-245	1U-5718	366	1U-6823	237
1U-5515	232	1U-5626	244-245	1U-5719	366	1U-6824	237
1U-5516	212	1U-5627	244-245	1U-5732	52	1U-6825	237
1U-5517	212	1U-5628	244-245	1U-5734	36, 53	1U-6826	237
1U-5518	211-212, 215	1U-5629	244-245	1U-5735	53	1U-6827	216
1U-5519	211-213, 215	1U-5630	244-245, 269-270	1U-5889	243	1U-6828	216
1U-5520	211-213, 215			1U-5890	245	1U-6829	216
1U-5536	52	1U-5631	244-245	1U-5891	245	1U-6832	216
1U-5545	19, 29	1U-5632	244-245	1U-5892	244	1U-6834	216
1U-5546	29, 31	1U-5633	244-245, 270	1U-5893	244	1U-6835	216
1U-5547	29, 31	1U-5634	245, 269	1U-6151	107	1U-6836	216
1U-5548	23, 29, 31	1U-5635	245, 270	1U-6152	107	1U-6837	216
1U-5549	29, 31	1U-5636	245	1U-6156	362	1U-6838	216
1U-5572	427-428	1U-5637	245	1U-6539	250	1U-6839	216
1U-5573	428	1U-5638	245, 269-270	1U-6540	250	1U-6841	216
1U-5574	428	1U-5639	245	1U-6600	252	1U-6842	216
1U-5575	427-428	1U-5640	245	1U-6659	306	1U-6843	216
1U-5576	428	1U-5641	245	1U-6660	306	1U-6844	216
1U-5577	428	1U-5642	245, 269	1U-6689	111	1U-6846	216
1U-5586	243	1U-5643	245, 270	1U-6691	111	1U-6854	234
1U-5587	243	1U-5644	245	1U-6692	111	1U-6855	234
1U-5588	243	1U-5645	245	1U-6700	243	1U-6856	234
1U-5589	243	1U-5646	245, 269	1U-6705	385	1U-6857	234
1U-5590	243	1U-5647	245, 270	1U-6706	385	1U-6858	234
1U-5591	243	1U-5648	245	1U-6707	385	1U-6859	234
1U-5592	243	1U-5649	245	1U-6708	385	1U-7234	175
1U-5593	243	1U-5682	244, 269, 275	1U-6709	386	1U-7250	160
1U-5594	243	1U-5683	244, 270	1U-6710	386	1U-7262	182
1U-5595	243	1U-5684	244, 269	1U-6725	252	1U-7296	161
1U-5596	243	1U-5685	244	1U-6726	252	1U-7318	308
1U-5597	243	1U-5686	244, 269-270, 275	1U-6728	153	1U-7319	308
1U-5598	243			1U-6784	230	1U-7321	19, 307

Part Number Index

Part No.	Page No.	Part No.	Page No.	Part No.	Page No.	Part No.	Page No.
1U-7322	307	1U-8091	351	1U-8791	42	1Y-3904	421
1U-7419	107	1U-8095	347	1U-8792	42	200-1928	44
1U-7427	360	1U-8096	347	1U-8798	96	200-1929	25, 45
1U-7428	236	1U-8097	358	1U-8801	431	200-1931	19, 45
1U-7429	206	1U-8099	358	1U-8805	426	200-8413	19, 68
1U-7433	244, 269, 277	1U-8100	358	1U-8808	426	200-8415	59, 68, 97
1U-7434	244, 269–270, 277	1U-8101	358	1U-8809	431	200-8417	59, 68, 97
1U-7435	244, 277	1U-8103	358	1U-9234	168, 183	200-8418	59, 68, 97
1U-7436	244, 277	1U-8104	359	1U-9236	168, 183	200-8419	59, 68, 97
1U-7437	244, 276	1U-8122	247	1U-9238	168, 183	200-8420	59, 68, 97
1U-7438	244, 276	1U-8126	247	1U-9366	171	200-8421	59, 68, 97
1U-7521	255	1U-8133	247	1U-9367	171	200-8422	59, 68, 97
1U-7559	46	1U-8138	247	1U-9368	171	200-8423	59, 68, 97
1U-7560	46	1U-8142	247	1U-9369	173	200-8424	59, 68, 97
1U-7561	46	1U-8143	247	1U-9474	107	200-8426	59, 68, 97
1U-7562	46	1U-8144	247	1U-9476	107	200-8427	59, 68, 97
1U-7563	21, 24–25, 46	1U-8145	247	1U-9531	309	200-8428	59, 68, 97
1U-7564	21, 24–25, 46	1U-8146	247–248	1U-9532	308–309	200-8429	59, 68, 97
1U-7565	21, 24–25, 46	1U-8147	247	1U-9533	309	202-8643	191
1U-7566	21, 24–25, 46	1U-8151	247	1U-9534	309	203-4290	159
1U-7567	21, 24–25, 46	1U-8152	247–248	1U-9535	309	203-5431	111
1U-7568	46	1U-8153	247	1U-9536	309	203-5432	111
1U-7569	21, 24–25, 46	1U-8156	247	1U-9537	309	203-5433	111
1U-7570	46	1U-8157	247	1U-9538	309	203-5434	111
1U-7571	46	1U-8158	247	1U-9539	309	203-5435	111
1U-7572	46	1U-8159	247–248	1U-9547	311	204-7932	262
1U-7573	46	1U-8160	247, 275	1U-9698	417	204-7933	262
1U-7574	46	1U-8161	247	1U-9707	250	204-7934	262
1U-7575	46	1U-8162	247	1U-9708	252	204-7935	262
1U-7576	46	1U-8163	247	1U-9709	250	204-7936	262
1U-7577	46	1U-8164	247	1U-9732	385	206-4496	278
1U-7578	46	1U-8165	247–248, 277	1U-9733	385	206-4499	278
1U-7579	46	1U-8166	247	1U-9734	385	207-0631	159
1U-7580	46	1U-8167	247, 275	1U-9763	433	207-1515	24
1U-7581	46	1U-8168	247	1U-9787	236	207-1601	425
1U-7582	46	1U-8169	247–248, 277	1U-9788	206	207-2736	146
1U-7583	46	1U-8170	247	1U-9915	178	207-8155	104
1U-7584	46	1U-8171	247, 275	1U-9916	178	207-8160	115
1U-7585	21, 24–25, 46	1U-8172	247	1U-9917	178	208-6183	18, 168
1U-7586	46	1U-8173	247, 277	1U-9918	178	211-0136	19, 21, 190
1U-7587	162	1U-8174	247	1U-9919	179	211-0616	19
1U-7591	162	1U-8184	248	1U-9920	179	211-0617	20
1U-7592	162	1U-8209	358	1U-9921	180	212-8144	19–21, 23
1U-7593	162	1U-8281	234	1U-9939	207	212-8145	19–20, 23, 182
1U-7610	255	1U-8282	234	1U-9940	207	212-8146	182
1U-7622	210–211	1U-8283	234	1U-9941	207	213-1983	19, 21, 26, 151
1U-7623	210–211, 213	1U-8285	230	1U-9942	207	213-1985	20, 22–23, 62, 182
1U-7626	104	1U-8286	230	1U-9943	207	213-3086	77
1U-7627	104	1U-8586	96	1U-9945	207	213-3087	77, 91
1U-7628	104	1U-8701	91	1U-9946	207	213-3088	77, 91
1U-7629	104	1U-8757	366	1U-9957	206	213-3089	77, 91
1U-7630	104	1U-8758	153	1U-9971	206	213-3091	77, 91
1U-7631	104	1U-8759	153	1U-9972	206	213-3094	77, 91
1U-7632	46	1U-8760	42	1U-9974	206	213-3099	77, 91
1U-7648	366	1U-8764	246	1U-9977	179	213-3092	77, 91
		1U-8765	246	1U-9978	179	213-3102	77, 91

Part Number Index

Part.No.	Page.No.	Part.No.	Page.No.	Part.No.	Page.No.	Part.No.	Page.No.
213-3104	77, 91	214-1157	64, 88	214-6567	93	214-7217	31
213-3107	77, 91	214-1158	64, 88	214-6568	93	214-7218	31
213-3109	77, 91	214-1159	64, 88	214-6569	93	214-7219	22
213-3110	77, 91	214-1160	64, 88	214-6570	93	214-7220	31
213-3515	77	214-1161	71	214-6571	93	214-7222	21, 31
213-3516	77, 91	214-1162	71, 90	214-6572	93	214-7223	21, 25, 31
213-3517	77, 91	214-1163	71, 90	214-6599	93	214-7314	49
213-3518	77, 91	214-1164	71, 90	214-6600	93	214-7315	49
213-3520	77, 91	214-1165	71, 90	214-6601	93	214-7316	62
213-3521	77, 91	214-1166	71, 90	214-6602	93	214-7318	21
213-3522	77, 91	214-1167	71, 90	214-6603	93	214-7319	62
213-3523	77, 91	214-1168	71, 90	214-6604	93	214-7320	106
213-3524	77, 91	214-1169	71, 90	214-6605	93	214-7321	106
213-3525	77, 91	214-1170	71, 90	214-6606	93	214-7322	25, 39
213-3526	77, 91	214-1171	71, 90	214-6607	93	214-7323	39
213-3528	77, 91	214-1172	71, 90	214-6608	93	214-7324	25
213-3530	77, 91	214-3635	256	214-6609	93	214-7326	62
213-4437	55, 115	214-6142	106	214-6611	93	214-7327	106
213-4443	55	214-6153	21	214-6612	93	214-7328	106
213-6923	78	214-6490	65	214-6613	93	214-7329	21, 25, 48
213-6924	78, 102	214-6491	65, 87	214-6614	93	214-7330	21, 39
213-6926	21, 25, 78, 101	214-6492	65, 87	214-6620	66	214-7331	106
213-6927	21, 25, 78, 101	214-6493	65, 87	214-6621	66, 98	214-7332	39
213-6928	78, 101	214-6494	65, 87	214-6623	66, 98	214-7333	61
213-6929	21, 25, 78, 101	214-6495	65, 87	214-6624	66, 98	214-7335	49
213-6930	78, 102	214-6496	65, 87	214-6625	66, 98	214-7339	60-61
213-6932	78, 102	214-6497	89	214-6626	66, 98	214-7340	60-61
213-6933	78, 102	214-6498	70	214-6627	66, 98	214-7341	61
213-6934	78, 102	214-6500	70, 90	214-6628	66, 98	214-7342	148
213-6935	78, 102	214-6501	70, 90	214-6629	66, 98	214-7346	79, 102
213-6936	78, 102	214-6503	70, 90	214-6630	66, 98	214-7347	151
213-6937	78, 102	214-6504	70, 90	214-6631	66, 98	214-7349	137
213-9967	86	214-6506	70, 90, 93	214-6632	66, 98	214-7350	137
213-9968	68, 86	214-6507	70, 90	214-6633	66, 98	216-1685	112
213-9969	68, 86	214-6509	70, 90	214-6634	67-68	217-1591	288
213-9970	68, 86	214-6510	70, 90	214-6635	67, 98	222-3048	119, 122
213-9971	68, 86	214-6511	70, 90	214-6636	67, 98	222-3050	120, 122
213-9972	68, 86	214-6512	70, 90	214-6637	67, 98	222-3053	120, 122
213-9974	68, 86	214-6513	70, 90	214-6638	67, 98	222-3054	121-122
213-9978	68, 86	214-6514	70, 90	214-6639	67, 98	222-3055	121-122
213-9980	68, 86	214-6521	83, 91	214-6640	67, 98	222-3059	128
213-9981	68, 86	214-6522	83, 91	214-6641	67, 98	222-3061	126
214-1143	64	214-6523	83, 91	214-6642	67, 98	222-3062	126
214-1144	64, 87	214-6524	83, 91	214-6643	78, 80	222-3063	123
214-1145	64, 87	214-6526	83, 91	214-6644	78, 102	222-3064	123, 217
214-1146	64, 88	214-6553	92	214-6645	78, 102	222-3065	123, 217
214-1147	64, 88	214-6554	92	214-6646	78, 102	222-3067	123
214-1148	64, 88	214-6556	92	214-6647	78, 102	222-3068	123
214-1149	64, 88	214-6557	92	214-6648	78, 102	222-3069	124
214-1150	64, 88	214-6558	92	214-6649	78, 102	222-3071	125
214-1151	64	214-6559	92	214-6650	78, 102	222-3074	125
214-1152	64, 88	214-6560	92	214-6651	78, 102	222-3076	125
214-1153	64, 88	214-6561	92	214-6652	78, 102	222-3077	125
214-1154	64, 88	214-6562	92	214-6653	79, 102	222-3080	127
214-1155	64, 88	214-6564	93	214-7214	31	222-3083	129
214-1156	64, 88	214-6565	93	214-7215	31	222-3084	123

Part Number Index

Part No.	Page No.	Part No.	Page No.	Part No.	Page No.	Part No.	Page No.
222-3110	424	227-4392	110	236-8038	229	239-4142	163
222-3111	419	227-4393	110	236-8041	219	239-4143	163
222-3112	419	227-4397	93	236-8043	219	239-4255	163
222-3115	423	230-0812	60-61	236-8048	219	239-4964	351
222-3120	415	230-0813	60-61	236-8049	219	239-4965	351
222-3121	434	231-3942	282	236-8051	219	239-4966	351
222-3122	415	231-4550	96	236-8052	219	239-4967	351
222-7876	18	231-6041	122	236-8053	219	239-6823	15, 55, 60-61
223-1154	130	231-6043	122	236-8054	219	239-6824	12, 16, 26, 56, 60-61
223-1693	158	231-6063	122	236-8055	220	239-6825	60-61
223-1694	158	231-6064	122	236-8056	220	239-6826	12, 16, 19, 21, 24-25, 56, 61
223-1695	158	231-6068	122	236-8061	227	240-1678	405
223-1697	158	231-6070	122	236-8066	229	241-0706	145-146
223-1698	158	231-6071	122	236-8067	229	241-0860	85
223-4352	127	231-6073	122	236-8068	229	241-0861	85
223-4353	127	231-6074	122	236-8069	216	241-0862	85
223-4354	127	231-6098	122	236-8070	222	241-0863	85
223-4355	127	231-7015	404	236-8071	222	241-0864	85
223-4356	127	231-7016	404	236-8072	218	241-0865	85
223-4357	130	231-7017	404	236-8073	218	241-0866	85
223-4358	130	231-7018	404	236-8074	218	241-0867	85
223-4359	130	231-9464	123	236-8075	218	241-0868	85
225-6502	412	231-9465	123-124	236-8076	218	241-0869	85
226-0102	127	231-9468	123	236-8078	218	241-0870	85
226-0124	127	231-9469	123	236-8079	218	241-0871	85
226-0125	241	232-0756	127	236-8081	218	241-0872	85
226-0126	241	232-5041	172	236-8082	218	241-0873	85
226-1900	160	233-1632	30	236-8083	218	241-0874	85
226-1901	160	233-1635	37	236-8092	213	241-0875	85
226-1902	160	233-1636	38	236-8093	239	241-8522	316
226-1903	160	233-1637	60	236-8094	239	241-8529	316
226-1904	160	233-1639	151	236-8095	239	241-8530	316
226-1905	160	233-1640	147	236-8096	239	241-9512	232
226-1906	160	233-1642	59	236-8097	239	242-0779	100
226-1907	160	233-8145	294	236-8098	239	242-6990	423
227-3129	160	233-8146	294	236-8100	239	243-1874	316
227-3130	160	233-8147	294	236-8101	239	243-1875	316
227-3131	160	233-8583	345, 381	236-8104	239	243-1876	316
227-3132	160	233-8584	345	236-8105	209	243-1877	316
227-3133	160	233-8585	349	236-8106	209	243-1878	316
227-3134	160	233-8586	349	236-8107	209	243-1879	316
227-3795	161	233-8587	349	236-8109	209	243-5173	106
227-3796	161	234-0544	126	236-8111	209	243-5174	106
227-3797	161	234-0545	126	236-8114	209	243-5175	106
227-3798	161	234-6041	97	236-8116	209	243-5177	106
227-3799	161	235-0844	373, 380-382	237-3653	222	243-5178	106
227-3800	161	235-0845	374, 380-382	237-5181	352	243-5179	106
227-4383	109	235-0847	375	238-8244	310	243-5180	106
227-4384	109	235-0848	380	239-1085	341	243-5181	106
227-4385	109	235-0849	378	239-1086	346	243-5182	108
227-4386	110	235-0850	377	239-1087	346	243-5183	108
227-4387	110	235-8598	389	239-1088	349	243-5184	108
227-4388	110	236-1169	152	239-1089	348	243-5185	108
227-4389	110	236-2648	294	239-1090	348	243-5186	108
227-4390	110	236-2654	294	239-4140	163	243-5187	108
227-4391	110	236-2655	294	239-4141	163	243-5188	108

Part Number Index

Part.No.	Page.No.	Part.No.	Page.No.	Part.No.	Page.No.	Part.No.	Page.No.
243-5189	108	246-8197	84	254-5319	225	261-8575	82
243-5190	108	246-8199	84	254-5320	225	261-8576	82
243-5450	412	246-8499	106	254-5321	225	261-8577	82
243-5451	412	247-4447	331	254-5322	225	261-8578	82
243-6495	126	247-6412	336	254-5323	225	261-8579	82
243-6496	126	247-6413	336	254-5324	226	261-8581	81
244-0910	162	247-9662	276	254-5325	226	261-8583	81
245-3224	309-310	247-9663	276	254-5326	226	261-8585	81
245-9823	158	248-2283	189	254-5327	226	261-8586	81
246-5147	328	248-8810	33	254-5328	226	261-8587	81
246-5149	328	248-8811	33	254-5329	226	261-8589	81
246-5151	328	248-8812	33	254-5330	226	261-8590	81
246-5155	329	248-8813	33	254-5331	226	261-8591	81
246-5163	329	248-8814	33	254-5332	226	262-2758	138
246-5164	332	248-8815	33	254-5333	226	262-2759	138
246-5165	330	248-8816	33	254-5334	226	262-4862	403
246-5167	331	248-8817	33	254-5335	226	262-4866	353
246-5179	334	248-8818	33	254-5336	209	262-4868	242
246-5180	333	248-8819	35	254-5337	209	262-9176	337
246-5181	334	248-8820	35	254-5338	209	262-9301	337
246-7509	123	248-8822	35	254-5339	209	262-9720	208
246-7511	277	248-8823	35	254-5340	209	262-9721	207
246-7513	277	248-8824	35	254-5341	209	262-9722	207
246-7514	277	248-8825	35	254-5342	209	262-9723	207
246-7515	277	248-8826	35	254-5345	210	262-9724	208
246-7516	277	248-8827	35	254-5346	210	262-9725	208
246-7517	277	248-8828	35	254-5347	210	262-9726	207
246-7518	277	248-8829	35	254-5348	210	262-9727	207
246-7519	277	248-8830	35	254-5349	210	262-9728	208
246-7520	277	248-8831	35	254-5350	210	262-9729	208
246-7521	277	248-8832	35	254-5351	210	262-9732	233
246-7522	277	249-1815	412	256-4816	24	262-9736	219
246-7523	277	249-5284	208	256-4879	25, 45	262-9737	233
246-7524	277	249-5285	208	258-5686	95	262-9738	222
246-7525	277	249-5286	208	259-7005	334	262-9739	225
246-7526	277	249-7265	341	259-7006	334	262-9740	233
246-7528	277	250-6865	174	259-7007	333	262-9741	234
246-8173	83	250-6866	174	259-7008	333	262-9742	235
246-8175	83	254-3422	370	260-1779	334	262-9743	235
246-8176	83	254-3767	380	260-3764	137	262-9744	235
246-8177	83	254-3768	381	260-3765	137	262-9745	235
246-8178	83	254-3769	382	260-3766	137	262-9746	239
246-8179	83	254-3770	376, 381	260-4783	348	262-9747	239
246-8180	83	254-3969	373, 380, 382	260-4785	348	262-9748	239
246-8181	83	254-5307	216-217	261-0022	310	262-9749	179
246-8182	83	254-5308	216-217	261-0024	311	262-9750	179
246-8184	83	254-5309	216-217	261-0114	375	262-9752	179
246-8185	84	254-5310	207	261-0115	376	262-9959	408
246-8186	84	254-5311	207	261-0443	55, 115	262-9980	232
246-8187	84	254-5312	207	261-0446	115	263-0794	401
246-8188	84	254-5313	207	261-8569	115	263-0796	401
246-8189	84	254-5314	207	261-8570	115	263-0867	346
246-8190	84	254-5315	207	261-8571	96	263-0877	387
246-8191	84	254-5316	225	261-8572	82	263-0879	388
246-8192	84	254-5317	225	261-8573	82	263-0881	386
246-8194	84	254-5318	225	261-8574	82	263-0883	387

Part Number Index

Part No.	Page No.	Part No.	Page No.	Part No.	Page No.	Part No.	Page No.
263-0884	408	263-7202	266	263-9074	169	270-5337	394
263-0885	402	263-7203	266	263-9075	169	270-5338	394
263-0886	402	263-7204	266	263-9076	169	270-5341	362
263-0887	402	263-7205	266	263-7144	265	270-5342	362
263-0891	396, 405	263-7206	266	264-0414	169	270-5343	395
263-0892	371	263-7207	266	264-4352	241	270-5344	395
263-1022	400	263-7208	266	264-4353	168	270-5345	395
263-1030	400	263-7209	266	264-4355	241	270-5346	402
263-1031	400	263-7210	266	264-4357	241	270-5347	361
263-3341	61	263-7211	266	264-4358	241	270-5348	393
263-3817	158	263-7212	266	264-4359	242	270-5349	393
263-3819	158	263-7213	266	264-4360	401	270-5350	393
263-3820	158	263-7215	266	264-4361	401	270-5351	393
263-3821	158	263-7216	266	264-4363	401	270-5352	393
263-3822	158	263-7217	266	264-4364	401	270-5353	393
263-7140	265	263-7218	266	264-4372	241	271-1648	415
263-7141	265	263-7219	266	265-2255	369	271-4600	73
263-7142	265	263-7220	266	265-2256	370, 416	271-4601	73, 88
263-7145	265	263-7221	266	266-2281	241	271-4602	73, 88
263-7146	265	263-7222	266	266-2282	241	271-4603	73, 88
263-7147	266	263-7223	266	266-2283	241	271-4604	73, 88
263-7155	265	263-7224	266	266-3452	234	271-4605	73, 88
263-7156	265	263-7225	266	266-3736	118-119, 122	271-4606	73, 88
263-7157	265	263-7226	266	266-3737	118, 122	271-4607	73, 88
263-7158	265	263-7227	266	266-3738	87	271-4608	73, 88
263-7160	265	263-7228	266	266-3739	87	271-4609	73, 88
263-7161	265	263-7230	266	267-6532	370-371	271-4610	73, 88
263-7162	265	263-7232	266	267-6535	371	271-4611	73, 88
263-7163	265	263-7233	266	267-6536	371	271-4612	73, 88
263-7164	265	263-7234	266	267-8539	406	271-4613	73
263-7165	265	263-7235	266	267-8540	406	271-4615	73, 88
263-7167	265	263-7236	266	267-8541	406	271-4616	73, 88
263-7168	265	263-7238	266	267-8542	406	271-4617	73, 88
263-7170	265	263-7239	266	267-8543	406	271-4618	73, 89
263-7172	265	263-7240	266-267	267-8544	406	271-4619	73, 89
263-7173	265	263-7241	267	267-8545	406	271-4620	73, 89
263-7174	265	263-7242	267	268-5809	409	271-4621	73, 89
263-7175	265	263-7243	267	268-5814	409	271-4622	74
263-7177	265	263-7244	267	268-8709	216	271-4623	74, 99
263-7178	265	263-7245	267	269-1944	423	271-4624	74, 99
263-7179	265	263-7246	267	269-3123	310	271-4625	74, 99
263-7180	265	263-7249	266	269-3368	371	271-4626	74, 99
263-7181	265	263-7250	266	269-7255	233	271-4627	74, 99
263-7182	265	263-7251	266	269-7256	233	271-4628	74, 99
263-7183	265	263-7253	266	269-7257	233	271-4630	74, 99
263-7184	266	263-7254	266	269-7258	233	271-4631	74, 99
263-7190	266	263-7255	265	269-7259	233	271-4632	74, 99
263-7193	266	263-7256	265	269-7260	233	271-4633	74, 99
263-7194	266	263-7258	265	269-8297	418	271-4634	74, 99
263-7195	266	263-7259	265	270-5329	393	271-4635	74, 99
263-7196	266	263-7260	265	270-5331	393	271-4636	74, 99
263-7197	266	263-9067	169	270-5332	393	271-4637	74, 99
263-7198	266	263-9069	169	270-5333	393	271-4638	75
263-7199	266	263-9070	169	270-5334	394	271-4639	75, 100
263-7200	266	263-9071	169	270-5335	394	271-4640	75, 100
263-7201	266	263-9072	169	270-5336	394	271-4641	75, 100

Part Number Index

Part.No.	Page.No.	Part.No.	Page.No.	Part.No.	Page.No.	Part.No.	Page.No.
271-4642	75, 100	271-4723	113	276-0502	324	282-9530	328
271-4643	75, 100	271-4724	113	276-0731	281, 286	282-9531	329
271-4644	75, 100	272-1208	155-157	276-0740	281, 286	282-9532	329
271-4645	75, 100	272-1212	155, 157	276-0741	281, 286	282-9533	329
271-4646	75, 100	272-1215	155-157	276-0742	281, 286	285-1145	398
271-4647	75, 100	272-1218	155, 157	276-0743	281, 286	285-1146	398
271-4648	75, 83, 100	272-1222	156	276-0744	281, 286	285-1147	398
271-4650	75, 100	272-1223	156	276-0745	281, 286	285-1148	399
271-4651	75, 100	272-1224	155	276-0746	281, 286	285-1149	399
271-4652	75, 100	272-1225	155	276-0747	281, 286	285-1150	399
271-4653	75, 100	272-1227	155	276-0748	281, 286	287-2075	156
271-4654	75	272-1228	155	276-0749	281, 286	287-2076	156
271-4655	75, 99	272-1230	155	276-0750	281, 286	288-2512	117
271-4656	75, 99	272-1233	155	276-0751	281, 286-287	288-4209	368
271-4657	75, 99	272-1237	155	276-0752	281, 286	288-4210	368
271-4658	75, 99	272-1239	155	276-0753	281, 286	288-4211	368
271-4659	75, 99	272-1240	155	276-0754	281, 286	288-4212	368
271-4660	75, 99	272-1241	156	276-0755	281, 286	291-6710	392
271-4661	75, 99	272-1242	156	276-0756	281, 286	291-6711	392
271-4662	75, 99	272-1243	156	276-0757	281, 286	293-0712	62
271-4663	75, 99	272-1244	156	276-0758	287	293-2978	393
271-4664	75, 99	272-1245	156	276-0759	287	293-3025	19, 44
271-4665	75, 99	272-1246	156	276-0760	287	293-3026	19, 45
271-4666	75, 99	272-1247	156	276-0761	287	2B-0858	284
271-4667	75, 99	272-1248	156	276-0762	287	2B-1730	111
271-4668	75, 99	272-1249	156	276-7018	281	2B-1731	111
271-4669	74	272-1250	156	277-8790	14, 148	2B-2526	250
271-4670	74, 89	272-1251	156	279-2267	214, 224	2B-4317	179
271-4671	74, 89	272-1252	156	280-1555	426	2B-7408	284
271-4672	74, 89	272-1253	156	280-2675	118, 122	2B-7409	284
271-4673	74, 89	272-5745	432	280-2676	118, 122	2B-7457	284
271-4674	74, 89	273-3527	156	280-2677	118, 122	2B-9256	251
271-4675	74, 89	273-3528	157	280-2678	119	2J-2668	285
271-4676	74, 89	274-1677	146	280-2679	119, 122	2J-5608	285
271-4677	74, 89	274-7454	360	280-2680	119, 122	2M-2689	144
271-4678	74, 89	274-7455	360	280-2681	119, 122	2M-9780	283
271-4679	74, 89	274-7456	360	280-2682	120, 122	2P-2333	421
271-4680	74, 89	274-7457	361	280-2683	120, 122	2P-2334	94
271-4681	74, 89	274-7458	360	280-2684	121-122	2P-2335	94
271-4683	76	275-5265	220	280-8144	430	2P-2336	94
271-4684	76, 99	275-5266	220	280-8147	430	2P-2338	94
271-4685	76, 99	276-0487	325	280-8148	430	2P-5475	70, 90
271-4686	76, 99	276-0488	325	280-8961	429	2P-5476	70, 90
271-4687	76, 99	276-0489	325	281-8271	220	2P-5477	70, 90
271-4688	76, 99	276-0490	325	281-8272	220	2P-5478	70, 90
271-4689	76, 99	276-0491	323	281-8273	220	2P-5479	70, 90
271-4690	76, 99	276-0492	323	281-8274	220	2P-5481	48, 70, 90
271-4691	76, 99	276-0493	323	281-8275	220	2P-5482	70, 90
271-4692	76, 100	276-0494	323	281-8282	220	2P-5483	70, 90
271-4693	76, 100	276-0495	324	282-2108	260	2P-5484	70, 91
271-4694	76, 100	276-0496	324	282-2111	260	2P-5487	52
271-4695	76, 100	276-0497	324	282-2112	260	2P-5488	52
271-4696	76, 100	276-0498	324	282-2113	260	2P-5489	52
271-4697	76, 100	276-0499	324	282-2115	260	2P-5490	19, 70
271-4700	28	276-0500	324	282-2116	260	2P-5491	52
271-4722	113	276-0501	324	282-9529	328	2P-5492	52

Part Number Index

Part No.	Page No.	Part No.	Page No.	Part No.	Page No.	Part No.	Page No.
2P-5493.....	52	305-3129	53	316-0704	151	384-8706	384
2P-5494.....	52	306-9601	397	316-0705	151	385-1722	187
2P-5495.....	52	307-3013	342	316-0706	14, 18, 151	385-1723	187
2P-5496.....	52	307-3014	342	316-0707	151	385-1724	187
2P-5497.....	260	307-3015	342	317-2806	139	385-1725	187
2P-5520.....	52	307-3017	342	323-6267	91	385-1726	186
2P-5529.....	260	307-3018	342	329-6922	190	385-1727	186
2P-5530.....	256	307-3019	342	329-6983	188	385-1728	186
2P-5531.....	256	307-3025	344	331-1264	157	385-1729	186
2P-5532.....	256	307-9919	375, 380	332-1471	394	385-1731	185
2P-5533.....	256	307-9920	375	376-4937	140	385-1737	189
2P-5534.....	256	307-9921	377	377-5722	295	385-1738	189
2P-5535.....	260	307-9922	376	377-5732	327	385-1742	143
2P-5537.....	260	307-9923	377	377-5733	327	385-1743	143
2P-5538.....	260	307-9924	377	377-5734	326	385-5553	335
2P-8253.....	43	307-9925	376	377-5735	326	385-5554	335
2P-8261.....	115	307-9926	377	377-5736	326	385-5555	335
2P-8263.....	106	307-9927	376	377-5737	325	385-5557	330
2P-8264.....	106	307-9928	377	377-5738	325	385-5560	376
2P-8265.....	106	308-6384	343	377-5739	325	385-8474	384
2P-8266.....	106	308-6391	343	377-5740	325	385-8475	384
2P-8267.....	106	308-6393	343	377-5741	325	386-3218	256
2P-8268.....	106	309-2454	343	377-5742	327	386-3219	256
2P-8269.....	106	309-2455	343	377-5743	327	386-3220	256
2P-8271.....	106	309-2456	343	377-5744	327	386-3221	256
2P-8272.....	106	309-2458	343	377-5745	327	386-3225	96
2P-8273.....	106	309-4932	342	377-5746	327	386-3226	96
2P-8275.....	106	310-5678	367	377-5747	330	386-3227	96
2P-8276.....	92	310-5713	367	377-5748	330	386-3228	97
2P-8289.....	192	310-5715	367	377-5749	330	386-3229	97
2P-8312.....	154	310-5716	367	377-5750	323	386-3230	96
2P-8338.....	296	310-5744	367	377-5751	323	386-3231	97
2P-9697.....	282	311-2979	407	377-5752	323	386-3232	97
2R-5657.....	284	311-2980	407	377-5753	326	386-3234	97
2S-4078.....	283	311-2981	407	377-5754	326	386-3235	176
2S-7905.....	283	311-2983	407	377-5755	326	386-3236	175
2Y-5841.....	285	311-2984	407	377-5756	328	386-3237	176
2Y-6461.....	285	311-2985	407	377-5757	328	386-3238	410
2Y-6462.....	285	311-2986	407	377-5758	328	386-3245	96
300-5899	304	311-2987	407	377-5759	334	386-3246	96
301-9696	369	311-2988	407	377-5760	334	386-3247	96
303-9339	369	311-3136	369	377-5761	334	386-3249	96
305-3115	54	312-0985	157	377-5762	335	386-3252	105
305-3116	54	312-0988	157	377-5763	335	386-3254	62
305-3117	54	312-0992	157	377-5764	335	386-3257	95
305-3118	54	312-0996	157	381-0022	430	386-3258	95
305-3119	54	312-0999	157	381-7607	335	386-3259	95
305-3120	54	312-1002	157	381-7608	335	386-3261	103
305-3121	54	312-1009	157	381-7609	335	386-3262	104
305-3122	54	312-1010	157	381-7611	336	386-3264	62
305-3123	54	312-1012	157	381-7612	333	386-3266	93
305-3124	54	312-1014	157	381-7613	333	386-3267	93
305-3125	54	312-7677	157	381-7614	333	386-3268	93
305-3126	54	312-7678	157	383-8887	175	386-3274	31
305-3127	54	316-0702	151	384-6821	136	386-3275	31
305-3128	54	316-0703	151	384-6822	136	386-3276	31

Part Number Index

Part.No.	Page.No.	Part.No.	Page.No.	Part.No.	Page.No.	Part.No.	Page.No.
386-3277	31	386-3338	101	416-2693	279-280	463-6821	116
386-3278	31	386-3340	137	423-8713	256	467-9234	373
386-3279	31	386-3348	137	423-8977	41	471-9317	188
386-3280	31	386-3349	139	429-0608	164	473-6461	383
386-3281	31	386-3351	158	429-0609	167	4B-4845	284
386-3282	31	386-3352	31	429-0610	164	4C-2959	424
386-3283	31	386-3353	92	429-0611	165	4C-2960	424
386-3284	31	386-3358	102	429-0612	165	4C-3302	132
386-3286	51	386-3359	62	429-0613	166	4C-3304	132
386-3287	51	386-3363	158	429-0614	166	4C-3335	247
386-3288	51	386-3364	173	429-0615	167	4C-3336	247
386-3289	51	386-3366	148	429-0616	167	4C-3337	247
386-3290	51	386-3367	54	430-4389	129	4C-3338	247
386-3291	51	386-3368	49	430-4392	129	4C-3339	247
386-3292	51	386-3369	149	430-4394	129	4C-3340	247
386-3293	51	386-3370	149	430-4396	129	4C-3341	247
386-3294	51	386-3371	149	432-6083	279-280	4C-3342	247
386-3295	51	386-3372	149	432-6084	279-280	4C-3343	247
386-3296	51	386-3373	150	432-6085	279-280	4C-3344	247
386-3297	51	386-5102	319	432-6086	279-280	4C-3345	247
386-3298	51	389-2195	357	432-6087	279-280	4C-3347	247
386-3299	51	390-3319	394	432-8907	93	4C-3348	247
386-3300	51	391-2683	410	435-3382	140	4C-3349	247
386-3301	51	391-2684	410	435-4061	340	4C-3350	247
386-3304	40	391-2685	410	435-4062	345	4C-3351	247
386-3305	162	396-2005	339	435-5074	184	4C-3352	247
386-3306	105	396-2006	339	435-9843	281	4C-3353	247
386-3307	105	396-2007	19, 339	435-9844	281	4C-3354	247
386-3308	105	396-2008	339	435-9845	281	4C-3355	247
386-3309	105	396-2009	339	437-1415	351	4C-3356	247
386-3310	104	396-2010	338	437-1416	351	4C-3357	247
386-3311	104	396-2011	338	437-4620	172	4C-3358	247
386-3312	104	396-2012	338	441-3703	171	4C-3359	247
386-3313	105	396-2013	338	441-5254	134	4C-3360	247
386-3314	104	396-2014	338	441-5255	131	4C-3361	247
386-3315	104	396-2015	338	444-6561	153	4C-3362	247
386-3316	104	3B-0551	284	447-1585	96	4C-3363	247
386-3317	104	3B-6352	111	447-1586	96	4C-3364	258-259
386-3318	104	3D-2824	283	449-8227	361	4C-3365	258-259
386-3319	104	3J-1907	283	450-9220	62	4C-3366	258-259
386-3320	104	3J-5390	283	451-9943	33	4C-3367	258-259
386-3321	104	3J-7354	283, 366	452-0539	115	4C-3368	258-259
386-3322	104	3K-0360	283	452-0541	115	4C-3369	258-259
386-3323	104	3K-8460	283	452-0542	115	4C-3370	258-259
386-3324	32	3M-7045	283	452-9933	161	4C-3371	259
386-3325	32	3P-1535	42	452-9934	161	4C-3372	258-259
386-3326	32	3P-1536	42	452-9936	161	4C-3374	258-259
386-3327	32	3P-1537	42	452-9937	161	4C-3375	258-259
386-3328	32	3P-1549	192	454-3162	31	4C-3376	258-259
386-3329	32	3P-2210	87	459-0184	429	4C-3377	258-259
386-3330	32	3P-2213	253	460-3238	341	4C-3378	258-259
386-3331	32	3P-2230	92	461-2616	341	4C-3379	259
386-3332	32	3P-2240	113	463-1899	52	4C-3380	258
386-3333	32	3S-0459	14, 17, 158	463-3105	145	4C-3381	259
386-3335	90	3S-0460	14, 17, 158	463-3106	145	4C-3382	259
386-3337	102	3S-2093	405	463-5569	411	4C-3383	259

Part Number Index

Part No.	Page No.	Part No.	Page No.	Part No.	Page No.	Part No.	Page No.
4C-3384.....	259	4C-3856.....	238	4C-4421.....	246	4C-4961.....	254
4C-3722.....	193	4C-3863.....	227	4C-4422.....	246	4C-4962.....	254
4C-3723.....	193	4C-3864.....	230	4C-4423.....	246	4C-4963.....	254
4C-3724.....	193	4C-3865.....	230	4C-4424.....	246	4C-4965.....	256
4C-3725.....	193	4C-3868.....	214, 224	4C-4425.....	246	4C-4966.....	256
4C-3741.....	294	4C-3975.....	192	4C-4426.....	248	4C-4967.....	256
4C-3742.....	294	4C-4055.....	366	4C-4463.....	193	4C-4968.....	256
4C-3743.....	294	4C-4056.....	366	4C-4511.....	396	4C-4969.....	256
4C-3745.....	295	4C-4057.....	366	4C-4512.....	396	4C-4970.....	256
4C-3746.....	295-296	4C-4065.....	49	4C-4513.....	396	4C-4971.....	250
4C-3747.....	296	4C-4067.....	46	4C-4514.....	396	4C-4972.....	250
4C-3748.....	296	4C-4094.....	386, 390	4C-4515.....	396	4C-4973.....	250
4C-3749.....	296	4C-4095.....	387, 390	4C-4516.....	396	4C-4974.....	250
4C-3750.....	296	4C-4099.....	390	4C-4517.....	396	4C-4975.....	250
4C-3751.....	294	4C-4100.....	390	4C-4518.....	396	4C-4976.....	250
4C-3752.....	294	4C-4175.....	232	4C-4600.....	366	4C-4977.....	250
4C-3753.....	294	4C-4181.....	254	4C-4601.....	112	4C-4978.....	250
4C-3754.....	294	4C-4182.....	254	4C-4730.....	192	4C-4979.....	250
4C-3755.....	297	4C-4183.....	412	4C-4763.....	210-211, 213	4C-4980.....	250
4C-3756.....	297	4C-4184.....	412	4C-4764.....	211, 213	4C-4981.....	250
4C-3757.....	297	4C-4185.....	412	4C-4776.....	391	4C-4982.....	250
4C-3758.....	297	4C-4186.....	412	4C-4777.....	391	4C-4983.....	250
4C-3759.....	297	4C-4189.....	414	4C-4779.....	391-392	4C-4984.....	250
4C-3760.....	297	4C-4190.....	413	4C-4780.....	391-392	4C-4985.....	250
4C-3761.....	297	4C-4191.....	412	4C-4781.....	392	4C-4986.....	250
4C-3766.....	229	4C-4192.....	412	4C-4783.....	194	4C-4987.....	250
4C-3768.....	229	4C-4196.....	414	4C-4787.....	194	4C-4988.....	250
4C-3769.....	226	4C-4197.....	413	4C-4789.....	194	4C-4989.....	250
4C-3770.....	226	4C-4198.....	412	4C-4804.....	427	4C-4990.....	250
4C-3772.....	226	4C-4199.....	413	4C-4805.....	427	4C-4991.....	250
4C-3773.....	226	4C-4200.....	412	4C-4871.....	167-168	4C-4992.....	250
4C-3774.....	226	4C-4202.....	412	4C-4880.....	391-392	4C-4993.....	250
4C-3776.....	226	4C-4205.....	413	4C-4910.....	301	4C-4994.....	250
4C-3777.....	230	4C-4207.....	412	4C-4911.....	298	4C-4995.....	250
4C-3778.....	240	4C-4217.....	432	4C-4913.....	300	4C-4996.....	250
4C-3779.....	240	4C-4381.....	210-211, 213	4C-4914.....	300	4C-4997.....	250
4C-3780.....	240	4C-4382.....	210-211, 213	4C-4917.....	299-300	4C-4998.....	250
4C-3781.....	240	4C-4383.....	210-211	4C-4920.....	301	4C-4999.....	250
4C-3782.....	240	4C-4384.....	210-211	4C-4921.....	301	4C-5000.....	250
4C-3783.....	240	4C-4392.....	294	4C-4929.....	303	4C-5001.....	250
4C-3784.....	240	4C-4393.....	294	4C-4930.....	303	4C-5002.....	250
4C-3785.....	240	4C-4394.....	294	4C-4931.....	303-304	4C-5003.....	250
4C-3809.....	219	4C-4395.....	295	4C-4933.....	304	4C-5004.....	250
4C-3811.....	219	4C-4396.....	295	4C-4934.....	304	4C-5005.....	250
4C-3813.....	219	4C-4399.....	294	4C-4935.....	304	4C-5006.....	250
4C-3821.....	219	4C-4400.....	294	4C-4936.....	304	4C-5007.....	250
4C-3822.....	219	4C-4404.....	347	4C-4938.....	304	4C-5008.....	249
4C-3834.....	219	4C-4412.....	246	4C-4940.....	305	4C-5009.....	249
4C-3845.....	237	4C-4413.....	246	4C-4942.....	305	4C-5010.....	249
4C-3846.....	237	4C-4414.....	246	4C-4943.....	303, 305	4C-5011.....	249
4C-3849.....	237	4C-4415.....	246	4C-4944.....	304	4C-5012.....	249
4C-3850.....	237	4C-4416.....	246	4C-4946.....	304	4C-5013.....	249
4C-3852.....	237	4C-4417.....	246	4C-4957.....	254	4C-5014.....	249
4C-3853.....	238	4C-4418.....	246	4C-4958.....	254	4C-5015.....	249
4C-3854.....	238	4C-4419.....	246	4C-4959.....	254	4C-5016.....	249
4C-3855.....	238	4C-4420.....	246	4C-4960.....	254	4C-5017.....	249

Part Number Index

Part.No.	Page.No.	Part.No.	Page.No.	Part.No.	Page.No.	Part.No.	Page.No.
4C-5018.....	249	4C-6338.....	237	4C-6963.....	40	4C-8406.....	270
4C-5019.....	249	4C-6339.....	237	4C-6964.....	40	4C-8407.....	270
4C-5020.....	249	4C-6340.....	237	4C-6965.....	40	4C-8409.....	270
4C-5021.....	249	4C-6341.....	237	4C-6973.....	40, 49	4C-8410.....	270
4C-5026.....	257	4C-6342.....	206	4C-6974.....	40	4C-8411.....	270
4C-5028.....	257	4C-6343.....	206	4C-6975.....	40	4C-8412.....	270
4C-5029.....	257	4C-6344.....	206	4C-6976.....	40	4C-8413.....	270
4C-5051.....	250	4C-6345.....	206	4C-6977.....	170	4C-8414.....	270
4C-5492.....	137	4C-6346.....	206	4C-6978.....	170	4C-8415.....	270
4C-5494.....	253	4C-6347.....	206	4C-6979.....	170	4C-8416.....	271
4C-5495.....	253	4C-6348.....	206	4C-6980.....	170	4C-8417.....	271
4C-5496.....	253	4C-6349.....	206	4C-6981.....	170	4C-8418.....	271
4C-5497.....	253	4C-6350.....	206	4C-6982.....	170	4C-8419.....	268-269, 272
4C-5522.....	331, 381	4C-6382.....	320	4C-6994.....	95	4C-8420.....	268-269, 272
4C-5523.....	331, 381	4C-6383.....	320	4C-8095.....	347	4C-8421.....	268-269, 272
4C-5526.....	332, 381	4C-6384.....	320	4C-8096.....	347	4C-8422.....	268-269, 272
4C-5527.....	332	4C-6385.....	320	4C-8097.....	347	4C-8423.....	268-269, 272
4C-5529.....	333	4C-6386.....	320	4C-8099.....	383	4C-8424.....	269, 272
4C-5530.....	259	4C-6387.....	319	4C-8101.....	383	4C-8425.....	268-269, 272
4C-5552.....	206	4C-6388.....	319	4C-8217.....	104	4C-8426.....	269, 272
4C-5637.....	305	4C-6389.....	319	4C-8364.....	268	4C-8427.....	269, 272
4C-5638.....	305	4C-6390.....	319	4C-8365.....	268	4C-8428.....	268, 271
4C-5647.....	162	4C-6391.....	319	4C-8366.....	269	4C-8429.....	268, 271
4C-5742.....	162	4C-6392.....	390	4C-8368.....	269	4C-8430.....	268, 271
4C-5746.....	134	4C-6393.....	318	4C-8369.....	269	4C-8431.....	271
4C-5751.....	378	4C-6394.....	319	4C-8370.....	269	4C-8432.....	268, 271
4C-5819.....	137	4C-6395.....	319	4C-8371.....	269	4C-8433.....	268-269
4C-5842.....	412	4C-6396.....	319	4C-8372.....	269	4C-8434.....	268-269, 272
4C-5843.....	412	4C-6477.....	312	4C-8373.....	269	4C-8435.....	268-269
4C-5877.....	397, 406	4C-6478.....	312	4C-8374.....	269	4C-8436.....	268-269, 272
4C-5894.....	256	4C-6479.....	312	4C-8375.....	269	4C-8437.....	268-269, 272
4C-6122.....	412	4C-6508.....	434	4C-8376.....	269	4C-8438.....	268-269, 272
4C-6127.....	412	4C-6571.....	385	4C-8377.....	268	4C-8439.....	269, 272
4C-6129.....	412	4C-6572.....	385	4C-8378.....	268	4C-8440.....	269, 272
4C-6130.....	414	4C-6573.....	385	4C-8379.....	268	4C-8441.....	269, 272
4C-6153.....	207	4C-6581.....	350	4C-8383.....	269	4C-8442.....	269, 272
4C-6154.....	207	4C-6715.....	433	4C-8385.....	269	4C-8443.....	272
4C-6157.....	207	4C-6722.....	254	4C-8386.....	269	4C-8444.....	269, 272
4C-6158.....	208	4C-6723.....	94	4C-8387.....	269	4C-8445.....	269, 272
4C-6161.....	241	4C-6724.....	104	4C-8388.....	269	4C-8446.....	269, 272
4C-6322.....	236	4C-6741.....	309	4C-8389.....	269	4C-8447.....	269, 272
4C-6323.....	236	4C-6774.....	133	4C-8390.....	269	4C-8448.....	269-270, 272
4C-6324.....	236	4C-6775.....	133	4C-8391.....	269	4C-8449.....	269-270, 272
4C-6325.....	236	4C-6776.....	133	4C-8392.....	269	4C-8450.....	270, 272
4C-6326.....	237	4C-6778.....	134	4C-8394.....	269	4C-8451.....	269-270, 272
4C-6327.....	237	4C-6779.....	135	4C-8395.....	269	4C-8452.....	269-270, 272
4C-6328.....	237	4C-6792.....	431	4C-8396.....	269	4C-8453.....	270, 272
4C-6329.....	237	4C-6794.....	431	4C-8397.....	269	4C-8454.....	270, 272
4C-6330.....	237	4C-6796.....	420	4C-8398.....	270	4C-8455.....	270, 272
4C-6331.....	237	4C-6797.....	420	4C-8399.....	270	4C-8456.....	270, 272
4C-6332.....	237	4C-6833.....	295	4C-8400.....	270	4C-8457.....	270, 272
4C-6333.....	237	4C-6837.....	296	4C-8401.....	270	4C-8458.....	272
4C-6334.....	237	4C-6922.....	183	4C-8402.....	270	4C-8459.....	270, 272
4C-6335.....	237	4C-6923.....	183	4C-8403.....	270	4C-8460.....	270, 272
4C-6336.....	237	4C-6924.....	256	4C-8404.....	270	4C-8461.....	270, 272
4C-6337.....	237	4C-6962.....	40	4C-8405.....	270	4C-8462.....	270, 272

Part Number Index

Part No.	Page No.	Part No.	Page No.	Part No.	Page No.	Part No.	Page No.
4C-8463.....	270, 272	4C-9470.....	307	4C-9686.....	268–269, 273	5B-3254	39
4C-8464.....	270	4C-9563.....	138	4C-9687.....	268–269	5B-9169	284
4C-8465.....	270, 272	4C-9592.....	13, 17, 19–20, 22, 28, 30	4C-9688.....	269	5F-4764.....	14, 18–24, 162
4C-8466.....	271–272	4C-9593.....	13, 17, 28, 30	4C-9689.....	268–269	5H-4017	285
4C-8467.....	271	4C-9594.....	13, 17, 19–21, 28, 30	4C-9690.....	269	5H-4018	285
4C-8469.....	269	4C-9595.....	13, 17, 19–22, 28, 30	4C-9691.....	268–269	5H-4019	285
4C-8472.....	270	4C-9596.....	13, 17, 19–20, 28, 30	4C-9692.....	268–269	5H-4020	285
4C-8473.....	270	4C-9597.....	13, 17, 20, 28, 30	4C-9700.....	269	5H-4845	183
4C-8474.....	270	4C-9598.....	13, 17, 19–22, 26, 28, 30	4C-9702.....	269, 273	5H-8146	273
4C-8475.....	270, 273	4C-9599.....	13, 17, 26, 28, 30	4C-9703.....	269	5M-6213.....	283
4C-8477.....	270	4C-9600.....	28	4C-9704.....	269	5M-6214.....	283
4C-8478.....	271	4C-9601.....	13, 17, 19, 28, 30	4C-9706.....	269	5N-5561	424
4C-8479.....	271	4C-9602.....	13, 17, 28, 30	4C-9707.....	269	5P-0045.....	286
4C-8480.....	269	4C-9603.....	13, 17, 19, 28, 30	4C-9715.....	270	5P-0046.....	286
4C-8481.....	269	4C-9604.....	13, 17, 28, 30	4C-9716.....	270	5P-0047.....	286
4C-8482.....	269	4C-9605.....	14, 17, 19–20, 28, 30	4C-9717.....	270	5P-0048.....	286
4C-8483.....	269	4C-9606.....	28, 30	4C-9718.....	270	5P-0049.....	286
4C-8486.....	269	4C-9607.....	28, 30	4C-9720.....	268	5P-0050.....	286
4C-8489.....	270	4C-9608.....	28, 30	4C-9721.....	268	5P-0127.....	86
4C-8491.....	270	4C-9609.....	29–30	4C-9722.....	268	5P-0144.....	50
4C-8496.....	271	4C-9610.....	28	4C-9724.....	269	5P-0166.....	139
4C-8497.....	269, 272	4C-9611.....	30	4C-9725.....	269	5P-0167.....	50
4C-8510.....	234	4C-9616.....	359	4C-9727.....	269–270	5P-0294.....	53
4C-8511.....	224	4C-9617.....	359	4C-9730.....	269–270	5P-0302.....	150
4C-8512.....	224	4C-9618.....	359	4C-9731.....	270	5P-0324.....	52
4C-8513.....	224	4C-9645.....	256	4C-9732.....	270, 273	5P-0325.....	52
4C-8514.....	224	4C-9650.....	194–195	4C-9739.....	195	5P-0326.....	52
4C-8515.....	224	4C-9651.....	195	4C-9741.....	195	5P-0327.....	52
4C-8516.....	224	4C-9652.....	195	4C-9742.....	195	5P-0328.....	52
4C-8517.....	224	4C-9653.....	195	4C-9743.....	195	5P-0329.....	52
4C-8518.....	224	4C-9654.....	195	4C-9744.....	195	5P-0331.....	52
4C-8519.....	224	4C-9655.....	195	4C-9745.....	195	5P-0332.....	52
4C-8520.....	224	4C-9656.....	195	4C-9746.....	195	5P-0333.....	52
4C-8521.....	224	4C-9657.....	195	4C-9747.....	256	5P-0334.....	52
4C-8522.....	234, 240	4C-9658.....	194–195	4C-9748.....	96	5P-0335.....	52
4C-8523.....	234, 240	4C-9659.....	195	4C-9787.....	96	5P-0336.....	52
4C-8524.....	234, 240	4C-9660.....	195	4C-9798.....	174	5P-0946.....	191
4C-8624.....	236	4C-9662.....	195	4C-9799.....	300	5P-1661.....	51
4C-8625.....	236	4C-9663.....	195	4C-9801.....	305	5P-1662.....	94
4C-8626.....	236	4C-9664.....	195	4C-9802.....	305	5P-1720.....	19, 177
4C-8627.....	236	4C-9665.....	195	4C-9813.....	110	5P-1745.....	94
4C-8628.....	236	4C-9681.....	269	4C-9814.....	110	5P-1748.....	94, 113
4C-8629.....	236	4C-9682.....	268–269	4C-9818.....	114	5P-1749.....	113–114
4C-8630.....	225	4C-9683.....	268–269	4C-9819.....	114	5P-2299.....	282
4C-8637.....	218	4C-9684.....	269	4C-9917.....	303, 305	5P-2410.....	63
4C-8638.....	218	4C-9685.....	268–269	4C-9942.....	184	5P-2909.....	282
4C-8648.....	417			4C-9943.....	184	5P-3011.....	250
4C-8650.....	417			4C-9944.....	184	5P-3012.....	250, 252
4C-8733.....	173			4C-9945.....	184	5P-3013.....	250
4C-8996.....	108			4C-9946.....	183	5P-3038.....	108
4C-9442.....	307			4D-0514	284	5P-3053.....	93
4C-9448.....	307			4F-5166	162	5P-3054.....	93
4C-9463.....	307			4J-4382	283	5P-3277.....	19, 172
4C-9464.....	307			4J-7533.....	283	5P-3320.....	284
4C-9465.....	307			4K-1388.....	283	5P-3534.....	113–114
4C-9466.....	307			4S-7326.....	61	5P-3540.....	111

Part Number Index

Part.No.	Page.No.	Part.No.	Page.No.	Part.No.	Page.No.	Part.No.	Page.No.
5P-3579.....	94	6K-0806.....	405	6V-6045.....	192	6V-9101.....	22, 24–25, 31
5P-3580.....	94	6K-6307.....	283	6V-6067.....	430	6V-9102.....	22, 24–25, 31
5P-3581.....	94	6V-0006.....	152	6V-6068.....	430	6V-9103.....	22, 24–25, 31
5P-3588.....	115	6V-0024.....	94	6V-6096.....	193	6V-9104.....	22, 25, 31
5P-3920.....	19	6V-0094.....	115	6V-6105.....	193	6V-9110.....	71, 100
5P-3931.....	421	6V-0115.....	47	6V-6107.....	193	6V-9111.....	22, 25, 71, 100
5P-3975.....	425	6V-0185.....	210	6V-6126.....	193	6V-9112.....	22–23, 71, 100
5P-4205.....	47	6V-0186.....	210, 212–213	6V-6192.....	14, 18, 22, 151	6V-9113.....	22, 25, 71, 101
5P-4238.....	253–254	6V-0199.....	65, 87	6V-6193.....	14, 18, 151–152	6V-9114.....	23, 71, 101
5P-4299.....	282	6V-0852.....	366	6V-6194.....	14, 18, 151–152	6V-9115.....	71, 101
5P-4724.....	191	6V-1897.....	284	6V-6195.....	14, 18, 152	6V-9116.....	22–23, 25, 71, 101
5P-4996.....	282	6V-2002.....	94	6V-7013.....	181		
5P-5148.....	405	6V-2010.....	233	6V-7052.....	254	6V-9117.....	102
5P-5195.....	50	6V-2032.....	222–223	6V-7067.....	206	6V-9118.....	23, 102
5P-5197.....	153	6V-2033.....	223	6V-7091.....	206	6V-9119.....	23, 102
5P-5249.....	110	6V-2062.....	153	6V-7092.....	206	6V-9120.....	23, 102
5P-6587.....	111	6V-2091.....	252	6V-7093.....	206	6V-9124.....	148
5P-6588.....	111	6V-2104.....	47	6V-7094.....	206	6V-9449.....	192
5P-6589.....	111	6V-2123.....	108	6V-7095.....	206	6V-9451.....	140
5P-7253.....	106	6V-3000.....	321	6V-7096.....	206	6V-9454.....	140
5P-7254.....	50	6V-3001.....	321	6V-7145.....	192	6V-9455.....	140
5P-7255.....	50	6V-3007.....	194, 321	6V-7494.....	287	6V-9456.....	140
5P-7256.....	50	6V-3008.....	321	6V-7496.....	287	6V-9507.....	282
5P-7320.....	51	6V-3017.....	306	6V-7555.....	405	6V-9508.....	282
5P-7414.....	177	6V-3018.....	306	6V-7874.....	93, 103	6V-9509.....	282
5P-7429.....	137	6V-3019.....	306	6V-7932.....	14, 18, 20, 22–23, 25, 147–148	6V-9510.....	282
5P-7443.....	61	6V-3020.....	306	6V-7933.....	14, 18, 24, 147–148	6V-9511.....	282
5P-7444.....	61	6V-3021.....	306			6V-9512.....	282
5P-7445.....	61	6V-3022.....	306	6V-7934.....	14, 18–20, 23–24, 26, 147–148	6V-9513.....	282
5P-7684.....	283	6V-3023.....	306	6V-7935.....	14, 18–19, 21, 26, 147–148	7B-9665.....	284
5P-8676.....	113	6V-3025.....	306			7E-8716.....	281, 287
5P-8937.....	421	6V-3044.....	235	6V-7936.....	15, 18, 147–148	7F-9504.....	284
5P-9709.....	210, 212	6V-3072.....	192	6V-7937.....	15, 18, 147–148	7H-3171.....	284
5P-9718.....	210, 212–213	6V-3073.....	192	6V-7938.....	15, 148	7J-0204.....	283
5S-6076.....	58, 113	6V-3112.....	192	6V-7939.....	318	7K-1181.....	405
5S-6077.....	58, 94	6V-3146.....	139	6V-9074.....	273	7L-2505.....	284
5S-6078.....	58, 94	6V-3182.....	206	6V-9076.....	273	7M-7410.....	284
5S-6079.....	58, 94	6V-3183.....	206	6V-9082.....	269, 273	7M-7809.....	111
5S-6080.....	58, 94	6V-3280.....	284	6V-9083.....	268–269, 273	7M-8485.....	283
5S-6081.....	58, 61, 94	6V-4058.....	113	6V-9086.....	107	7N-0296.....	432
5S-6082.....	58, 94	6V-4086.....	214, 224	6V-9090.....	23, 26, 29–31	7N-7777.....	321
5S-6083.....	58, 94	6V-4087.....	224	6V-9091.....	29–31	7N-7778.....	321
5S-6084.....	58, 94	6V-4094.....	192	6V-9092.....	29–31	7N-7779.....	321
5S-6085.....	58, 94	6V-4154.....	139	6V-9093.....	23, 26, 29–31	7N-7780.....	321
5S-6086.....	58, 95	6V-4165.....	138	6V-9094.....	29–31	7N-7781.....	321
5S-6087.....	58, 94	6V-4166.....	138	6V-9095.....	29–31	7N-7782.....	321
5S-6088.....	58	6V-4167.....	138	6V-9096.....	22, 24–25, 27, 29–31	7N-8204.....	321
5S-6089.....	58, 62–63	6V-4168.....	138	6V-9097.....	23, 29–31	7N-8205.....	321
5S-6090.....	58, 63	6V-4169.....	138	6V-9098.....	22, 24–25, 27, 29–31	7N-9737.....	321
5S-6091.....	61	6V-4170.....	139			7N-9738.....	321
5S-6092.....	58, 191	6V-4171.....	138	6V-9099.....	22–25, 27, 29–31	7S-7093.....	252
5S-6093.....	58	6V-4175.....	94			7X-1062.....	432
5S-6094.....	61	6V-4802.....	238	6V-9100.....	31	7X-3387.....	366
6F-6946.....	181	6V-4873.....	192			8C-3345.....	366
6F-6947.....	181	6V-6035.....	176			8C-3445.....	366
6H-7378.....	43	6V-6044.....	192			8C-3446.....	366

Part Number Index

Part No.	Page No.	Part No.	Page No.	Part No.	Page No.	Part No.	Page No.
8C-3447.....	366	8H-8556	13, 17, 19, 21– 22, 56, 89	8S-1598.....	14, 92	8T-3068.....	253
8C-3451.....	366	8H-855761	8S-1599.....	14, 92	8T-3069.....	253
8C-4424.....	285	8H-8559	13, 17, 19–23, 57, 113, 182	8S-1600.....	14, 92	8T-3070.....	254
8C-8456.....	366	8H-8560	13, 115	8S-1601.....	14, 92	8T-3071.....	253
8F-2239.....	49	8H-8561	115, 182	8S-2257.....	408	8T-3072.....	253
8F-2243.....	39	8H-8562	12–13, 16, 81, 86	8S-2274.....	12, 16, 56, 87	8T-3073.....	253
8F-2246.....	39	8H-8563	12, 16, 81, 86	8S-2284.....	16, 81, 86	8T-3074.....	254
8F-4675.....	139	8H-8564	12, 16, 81, 86	8S-2357.....	65, 87	8T-3075.....	253
8F-4677.....	139	8H-8565	12, 16, 81, 86	8S-5128.....	193	8T-3076.....	253
8F-4678.....	139	8H-8566	12, 16, 81, 87	8S-5131.....	139	8T-3077.....	253
8F-5574.....	273	8H-8567	12, 16, 56, 87	8S-6034.....	273	8T-3078.....	254
8F-5575.....	273	8H-8568	12, 16, 56, 87	8S-6400.....	273	8T-3079.....	256
8F-5577.....	273	8H-8569	12, 16, 56, 87	8S-6402.....	273	8T-3080.....	256
8F-9866.....	19–27, 144	8H-8570	12, 16, 56, 87	8T-0460.....	12, 15	8T-3081.....	256
8H-8423	14, 27, 31	8H-8571	12, 16, 56, 87	8T-0461.....	15, 19	8T-3082.....	256
8H-8424	14, 22, 31	8H-8573	12, 16, 56, 63	8T-0832.....	161	8T-3083.....	256
8H-8501	14, 17, 48	8H-8574	12, 16, 56, 113	8T-0833.....	50	8T-3084.....	256
8H-8502	30–31	8H-8575	12, 16, 27, 56, 113	8T-0841.....	192	8T-3085.....	256
8H-8504	13, 57, 92	8H-8576	12, 16, 27, 115	8T-0886.....	27	8T-3086.....	256, 277
8H-8516	14, 31	8H-8577	15, 22, 25, 158	8T-2692.....	268–269	8T-3087.....	256
8H-8517	14, 27, 31	8H-8578	15, 18, 161	8T-2695.....	268–269	8T-3088.....	256
8H-8518	14, 31	8H-8579	15, 18	8T-2698.....	268–269	8T-3089.....	256, 277
8H-8519	14, 31	8H-8580	15, 18, 182	8T-2706.....	268–269	8T-3090.....	256
8H-8520	14, 27, 31	8H-8581	15, 18–20, 22– 24, 175	8T-2712.....	269	8T-3091.....	256
8H-8529	13, 57, 92	8L-8413.....	405	8T-2715.....	268	8T-3092.....	256
8H-8530	13, 57, 92	8M-8292.....	273	8T-2718.....	268	8T-3093.....	256
8H-8531	13, 57, 92	8S-1346.....	261	8T-2721.....	268	8T-3094.....	256
8H-8532	13, 57, 92	8S-1347.....	261	8T-2727.....	268–269	8T-3095.....	256
8H-8533	13, 57, 92	8S-1364.....	261	8T-2730.....	268–269	8T-3096.....	256
8H-8534	13, 57, 92	8S-1365.....	261	8T-2742.....	268–269	8T-3120.....	34
8H-8535	13, 57, 92	8S-1366.....	261	8T-2748.....	269	8T-3121.....	269–270
8H-8536	13, 20, 57, 92	8S-1368.....	261	8T-2751.....	269	8T-3122.....	34
8H-8537	13, 20, 57, 92	8S-1369.....	261	8T-2760.....	269	8T-3123.....	34
8H-8538	13, 20, 57, 92	8S-1370.....	261	8T-2763.....	270	8T-3124.....	34
8H-8539	13, 57, 92	8S-1371.....	261	8T-2763.....	270	8T-3125.....	34
8H-8540	13, 57, 92	8S-1372.....	261	8T-2772.....	270	8T-3126.....	34
8H-8541	13, 20, 57, 92	8S-1373.....	261	8T-2775.....	270	8T-3127.....	34
8H-8542	13, 57, 92	8S-1374.....	261	8T-2784.....	269–270	8T-3127.....	34
8H-8543	13, 57, 92	8S-1375.....	261	8T-2790.....	269–270, 273	8T-3128.....	34
8H-8544	13, 57, 92	8S-1376.....	261	8T-2793.....	269–270	8T-3129.....	34
8H-854561	8S-1377.....	261	8T-2796.....	270	8T-3130.....	34
8H-8546	13, 23, 58, 62	8S-1378.....	261	8T-2799.....	270, 273	8T-3131.....	34
8H-8548	13, 23, 57, 113	8S-1589.....	14, 16, 87	8T-2801.....	271	8T-3132.....	34
8H-8549	12, 16, 19–22, 56, 89	8S-1590.....	14, 16, 87	8T-2802.....	271	8T-3133.....	34
8H-8550	12, 16, 56, 89	8S-1591.....	14, 87	8T-2998.....	424	8T-3134.....	34
8H-8551	12, 16, 20, 56, 89	8S-1592.....	14, 87	8T-3041.....	71, 100	8T-3135.....	34
8H-8552	12, 17, 20–21, 56, 89	8S-1593.....	14, 89	8T-3042.....	106	8T-3136.....	34
8H-8553	12, 17, 20, 56, 89	8S-1594.....	14, 90	8T-3043.....	106	8T-3137.....	34
8H-8554	12, 17, 19–21, 56, 89	8S-1595.....	14, 90	8T-3052.....	141	8T-3138.....	34
8H-8555	13, 17, 19–20, 56, 89	8S-1596.....	14, 90	8T-3054.....	214, 224	8T-3153.....	193
		8S-1597.....	14, 92	8T-3055.....	224	8T-3196.....	51, 139
				8T-3062.....	253	8T-3227.....	34
				8T-3063.....	253	8T-5182.....	93
				8T-3064.....	254	8T-5183.....	113
				8T-3065.....	253	8T-5209.....	318
				8T-3066.....	254	8T-5211.....	318
				8T-3067.....	253	8T-5212.....	318

Part Number Index

Part.No.	Page.No.	Part.No.	Page.No.	Part.No.	Page.No.	Part.No.	Page.No.
8T-5213	318	9M-6593	273	9S-3638	276	9S-8002	283
8T-5214	318	9M-6595	273	9S-3641	277	9S-8003	283
8T-5215	318	9M-6596	273	9S-3642	277	9S-8004	283
8T-5216	318	9S-1711	15, 55, 86	9S-3643	277	9S-8005	283
8T-5217	318	9S-1712	15, 55, 86	9S-3644	277	9S-8006	283
8T-5218	318	9S-1713	15, 55, 86	9S-3645	277	9S-8007	283
8T-5219	318	9S-1714	15, 55, 86	9S-3646	277	9S-8008	283
8T-5230	110	9S-1715	15, 55, 86	9S-3647	277	9S-8009	283
8T-7696	263	9S-1716	15, 55, 86	9S-3648	276	9S-8010	283
8T-7697	263	9S-1717	15, 55, 86	9S-3651	277	9S-8105	193
8T-7698	263	9S-1718	15, 55, 86	9S-3652	277	9S-8895	282
8T-7699	263	9S-1719	15, 55, 86	9S-3653	277	9S-8927	282
8T-7748	222	9S-1720	15, 55, 113	9S-3654	277	9S-9149	50
8T-7751	232	9S-1721	15, 55, 59, 113	9S-3655	277	9S-9334	283
8T-7752	232	9S-1722	15, 55	9S-3656	277	9T-6322	285
8T-7765	232	9S-1724	16, 55, 59, 115	9S-3657	277	9U-5006	137
8T-7766	232-233	9S-1725	16, 55, 191	9S-3658	276	9U-5007	137
8T-7767	223	9S-1727	16, 81, 86	9S-3674	277	9U-5009	142
8T-7768	221, 223, 231	9S-1728	16, 56, 87	9S-3675	276	9U-5010	142
8T-7769	221	9S-1729	17, 56, 89	9S-3676	276	9U-5011	142
8T-7792	263	9S-1730	17, 19-20, 56, 90	9S-3677	276	9U-5012	142
8T-7793	263			9S-3678	276	9U-5014	139
8T-7794	263	9S-1731	17, 20, 56, 90	9S-3679	276	9U-5015	139
8T-7795	263	9S-1732	17, 19, 22, 24-25, 57, 113	9S-3680	276	9U-5017	138
8T-7876	366			9S-3700	276	9U-5019	137
8T-9110	263	9S-1742	18, 44	9S-4026	115	9U-5020	137
8T-9174	96	9S-1743	18, 50	9S-4027	115	9U-5027	418
8T-9175	96	9S-1746	56	9S-4028	115	9U-5029	418
8T-9201	263	9S-1747	81	9S-4180	283	9U-5030	418
8T-9202	263	9S-1748	56	9S-4181	283	9U-5031	427
8T-9208	366	9S-1749	57	9S-4182	283	9U-5032	427
8T-9265	113	9S-2573	16, 86	9S-4183	283	9U-5053	277
8T-9287	263	9S-3500	276	9S-4185	283	9U-5055	277
8T-9293	137	9S-3509	277	9S-4188	283	9U-5057	277
9A-1593	264	9S-3510	277	9S-4190	283	9U-5059	277
9B-1496	49	9S-3515	277	9S-4191	283	9U-5089	103
9F-2247	284	9S-3618	277	9S-5031	65, 87	9U-5101	142
9F-2636	144	9S-3619	277	9S-5054	277	9U-5121	271-272
9F-2637	144	9S-3620	277	9S-5056	277	9U-5122	271-272
9F-3869	49	9S-3621	277	9S-5058	277	9U-5123	271-272
9F-7143	273	9S-3622	277	9S-5060	277	9U-5124	271-272
9F-9398	253-254	9S-3623	277	9S-5518	282	9U-5125	271
9F-9963	111	9S-3624	277	9S-6130	283	9U-5130	30-31
9G-3667	322	9S-3625	277	9S-6369	94	9U-5155	174
9G-3668	322	9S-3626	277	9S-6370	94	9U-5177	273
9G-3669	321	9S-3627	277	9S-6371	94	9U-5604	273
9G-3670	321	9S-3628	277	9S-6372	94	9U-5614	263
9G-3671	321	9S-3629	277	9S-6373	94	9U-5615	263
9G-3672	321	9S-3630	277	9S-6374	94	9U-5784	299-300
9G-3673	322	9S-3631	276	9S-6375	94	9U-5794	256
9G-3674	322	9S-3632	276	9S-7351	138	9U-5922	388
9G-3675	322	9S-3633	276	9S-7352	138-140	9U-6009	312
9G-3676	321	9S-3634	276	9S-7353	138-139	9U-6010	312
9G-3677	321	9S-3635	276	9S-7354	138	9U-6124	82
9G-3678	321	9S-3636	276	9S-7583	283	9U-6125	82, 98
9G-3695	321	9S-3637	276	9S-8001	283	9U-6126	82, 98

Part Number Index

Part No.	Page No.	Part No.	Page No.	Part No.	Page No.	Part No.	Page No.
9U-6127	82, 98	9U-6558	95	9U-7070	281, 287	9U-7129	292
9U-6128	82, 98	9U-6559	95	9U-7071	281, 287	9U-7130	292
9U-6129	82, 98	9U-6560	95	9U-7072	287	9U-7131	292
9U-6130	82, 98	9U-6561	95	9U-7073	281, 287	9U-7132	292
9U-6131	82, 98	9U-6562	95	9U-7074	281, 287	9U-7133	292
9U-6132	82, 98	9U-6563	95	9U-7075	281, 287	9U-7134	292
9U-6133	82, 99	9U-6564	95	9U-7076	281, 287	9U-7135	292
9U-6182	182	9U-6565	95	9U-7077	281, 287	9U-7136	289
9U-6219	22, 25, 190	9U-6566	95	9U-7078	281, 287	9U-7137	289
9U-6282	139	9U-6567	95	9U-7079	281, 287	9U-7138	289
9U-6362	320	9U-6568	95	9U-7080	281, 287	9U-7139	289
9U-6363	320	9U-6569	95	9U-7081	281, 287	9U-7140	289
9U-6364	320	9U-6570	95	9U-7082	281, 287	9U-7141	289
9U-6366	320	9U-6571	95	9U-7084	287	9U-7142	289
9U-6368	320	9U-6572	95	9U-7085	281, 287	9U-7143	289
9U-6369	320	9U-6573	95	9U-7086	287	9U-7144	289
9U-6374	317	9U-6574	95	9U-7087	281, 287	9U-7145	289
9U-6378	317	9U-6575	95	9U-7088	281, 287	9U-7146	289
9U-6379	317	9U-6576	95	9U-7089	281, 287	9U-7147	289
9U-6382	227	9U-6577	96	9U-7090	281, 287	9U-7148	289
9U-6383	226	9U-6578	96	9U-7091	281, 287	9U-7149	289
9U-6503	256	9U-6579	96	9U-7092	287	9U-7150	289
9U-6517	35	9U-6580	96	9U-7094	287	9U-7151	289
9U-6523	80, 103	9U-6581	96	9U-7095	287	9U-7152	289
9U-6524	80, 103	9U-6582	96	9U-7096	287	9U-7153	289
9U-6525	80, 103	9U-6583	96	9U-7098	291	9U-7154	292
9U-6526	80, 103	9U-6584	96	9U-7099	291	9U-7155	292
9U-6527	80, 103	9U-6635	59, 61	9U-7100	291	9U-7156	292
9U-6528	80, 103	9U-6636	61	9U-7101	291	9U-7157	292
9U-6529	80, 103	9U-6637	61	9U-7102	291	9U-7158	292
9U-6530	80, 103	9U-6638	61	9U-7103	291	9U-7159	292
9U-6531	80, 103	9U-6639	61	9U-7104	290	9U-7160	292
9U-6532	80, 103	9U-6640	61	9U-7105	290	9U-7161	293
9U-6533	80, 103	9U-6708	312	9U-7106	290	9U-7162	293
9U-6534	80, 103	9U-6710	312	9U-7107	290	9U-7163	293
9U-6535	80, 103	9U-6712	312	9U-7108	290	9U-7164	293
9U-6536	80, 103	9U-6734	96	9U-7109	290	9U-7165	293
9U-6537	80, 103	9U-6901	256	9U-7110	290	9U-7166	288
9U-6538	80, 103	9U-6902	256	9U-7111	290	9U-7167	288
9U-6539	80, 103	9U-6910	389	9U-7112	290	9U-7168	288
9U-6540	80, 103	9U-6911	389	9U-7113	290	9U-7169	288
9U-6541	80, 103	9U-6912	389	9U-7114	290	9U-7170	288
9U-6542	80, 103	9U-6919	422	9U-7115	290	9U-7171	288
9U-6543	80, 103	9U-6921	211	9U-7116	290	9U-7172	288
9U-6544	80, 103	9U-6922	211	9U-7117	290	9U-7173	288
9U-6545	80, 103	9U-6923	211	9U-7118	290	9U-7174	288
9U-6546	80, 103	9U-6924	211	9U-7119	290	9U-7175	288
9U-6548	95	9U-6925	211	9U-7120	292	9U-7176	288
9U-6549	95	9U-6926	211	9U-7121	292	9U-7177	288
9U-6550	95	9U-6927	211	9U-7122	292	9U-7178	288
9U-6551	95	9U-6928	214	9U-7123	292	9U-7179	288
9U-6552	95	9U-6929	214	9U-7124	292	9U-7180	288
9U-6553	95	9U-7042	389	9U-7125	292	9U-7181	288
9U-6554	95	9U-7067	281, 287	9U-7126	292	9U-7182	288
9U-6555	95	9U-7068	281, 287	9U-7127	292	9U-7183	288
9U-6557	95	9U-7069	281, 287	9U-7128	292	9U-7184	288

Part Number Index

<u>Part.No.</u>	<u>Page.No.</u>	<u>Part.No.</u>	<u>Page.No.</u>	<u>Part.No.</u>	<u>Page.No.</u>	<u>Part.No.</u>	<u>Page.No.</u>
9U-7185	288	9U-7197	293	9U-7327	172	9U-7731	413
9U-7186	288	9U-7198	293	9U-7328	150	9U-7918	397
9U-7187	288	9U-7199	293	9U-7376	51	9U-7920	397
9U-7188	288	9U-7200	293	9U-7377	264	9U-7921	397
9U-7189	288	9U-7201	293	9U-7418	107	9U-7922	397
9U-7190	288	9U-7202	293	9U-7419	21, 47	9U-7946	413
9U-7191	288	9U-7203	312	9U-7551	424	9U-7947	413
9U-7192	288	9U-7231	307	9U-7714	412	9U-7949	413
9U-7193	288	9U-7283	256	9U-7719	413	9U-7968	22, 25
9U-7194	288	9U-7290	147	9U-7720	413		
9U-7195	293	9U-7291	148	9U-7725	413		
9U-7196	293	9U-7326	172	9U-7726	413		



<https://dealer.cat.com/en/ps/parts/parts-mktg/st-hardware-supplies.html>

BUILT FOR IT.™

PECJ0003-07
www.cat.com

© 2016 Caterpillar, All Rights Reserved. CAT, CATERPILLAR, BUILT FOR IT, their respective logos, "Caterpillar Yellow" and the "Power Edge" trade dress, as well as corporate and product identity used herein, are trademarks of Caterpillar and may not be used without permission.

